







HEKMAN®

A HOWARD MILLER COMPANY

23508 SHAPED LEG SOFA TABLE

Hardware List

A	B	C	D	E	
HEXAGON NUTS M18 (8 PCS.)	FLAT W. M18 8 PCS.	SPRING W. M18 8 PCS.	SCREW 06 X 3/4" (4 PCS.)	WRENCH (FOR HEXA BOLT) 1 PC.	
					

Assembly Instruction

STEP 1.

LAY TOP PANEL UPSIDE DOWN ON A SOFT, CLEAN AND FLAT SURFACE. ALIGN BOLTS IN APRON BLOCKS WITH HOLE IN LEGS. CONNECT USING FLAT WASHER (A), SPRING WASHER (B), HEXAGON NUTS (C) AND WRENCH (E) PROVIDED.

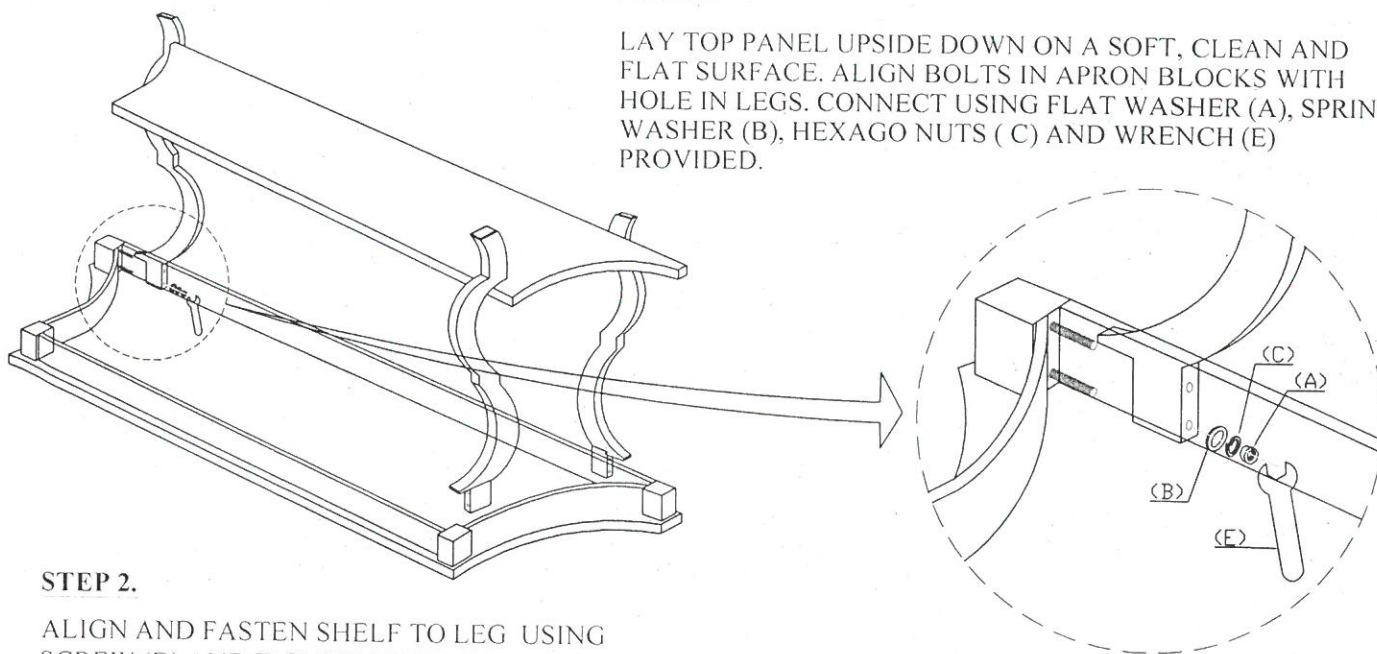

STEP 2.

ALIGN AND FASTEN SHELF TO LEG USING SCREW (D) AND TIGHTEN WITH SCREW DRIVER (NOT INCLUDED).

