

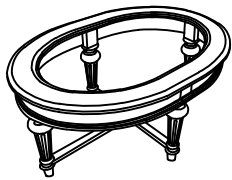





HEKMAN®

A HOWARD MILLER COMPANY

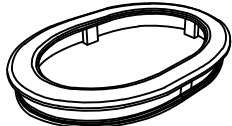
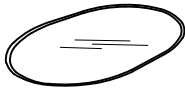
23300 SMALL COFFEE TABLE

HARDWARE LIST	
A	
SCREW Ø6 X 3/8" (8 PCS.)	
	

PART INSIDE				
1 TOP ASSEMBLY (1 Pc)	2 GLASS (1 Pc)	3 STRETCHER (1 Pc)	4 LEG (4 Pcs)	5 BUNFEET (4 Pcs)
				

Assembly Instruction

STEP 1.

LAY TOP ASSEMBLY UPSIDE DOWN ON A SOFT, CLEAN AND FLAT SURFACE.
PLACE THE LEGS (3) IN THE TOP ASSEMBLY (1) BRACKET FOUND INSIDE THE TOP ASSEMBLY USING SCREW (1) AND TIGHTEN WITH SCREW DRIVER (NOT INCLUDED).

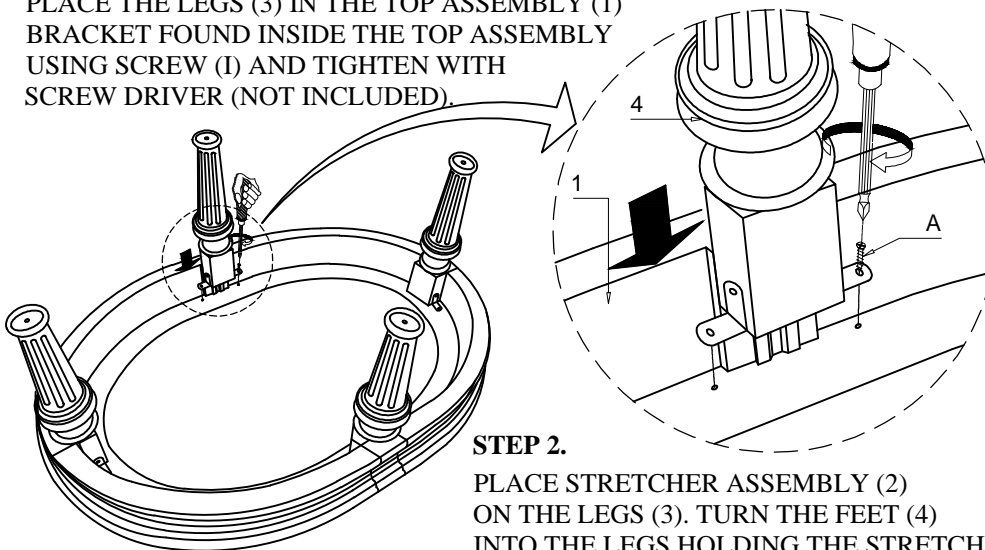

STEP 2.

PLACE STRETCHER ASSEMBLY (2) ON THE LEGS (3). TURN THE FEET (4) INTO THE LEGS HOLDING THE STRETCHER ASSEMBLY IN PLACE.

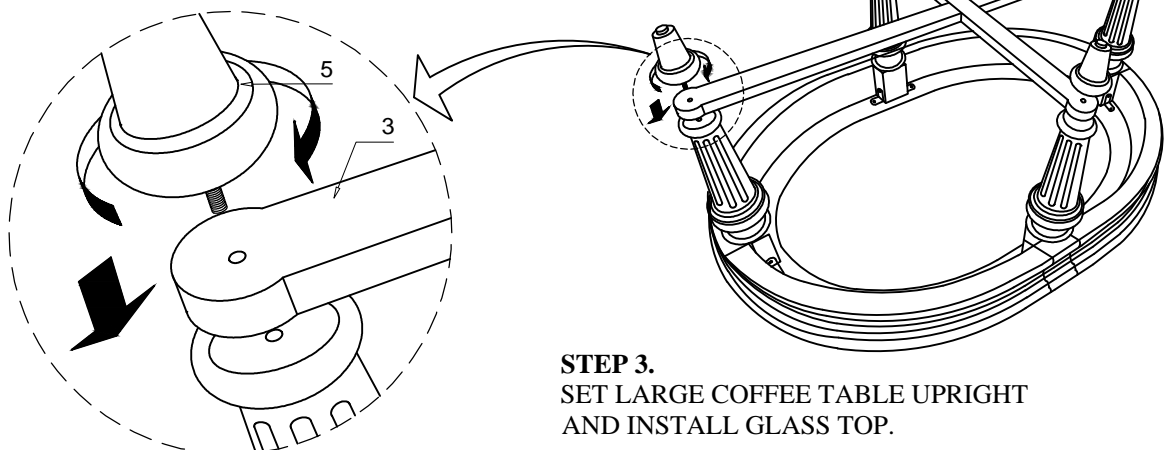

STEP 3.

SET LARGE COFFEE TABLE UPRIGHT AND INSTALL GLASS TOP.