

IMPORTANT SAFETY INSTRUCTIONS

When using electrical products, basic precautions should always be practiced including the following:

1. READ AND FOLLOW ALL SAFETY INSTRUCTIONS.
2. Read and follow all instructions provided with the product.
3. Unplug from outlet before shortening, cutting or installing this product.
4. Do not use an extension cord to supply power to the strip.
5. Do not use within 10 feet of a pool.
6. Do not use in a bathroom.
7. This product is NOT a toy.
8. To avoid damage, use only with the power supply provided.
9. Do not open the product. Use only as intended.
10. Do not roll up the product when using. Spread out to full length before connecting power supply.
11. Do not operate if any component is damaged.

WARNING:

Risk of Electric Shock. Mount the unit at a height greater than 1 foot from the ground surface.

SAVE THESE INSTRUCTIONS

This manual contains important safety and operating instructions to power the unit.

Need Help?



For 24/7 customer support, visit feit.com/help

Controller Module Button:



- Power Button: Turns the light on/off.
Press and hold for 5 seconds when lights are off to enter pairing mode.
- Mode Button: Cycles through the four preset modes.
- Music Button: Music Sync and TV Sync.

LIMITED WARRANTY. This product is warranted to be free from defects in workmanship and materials for up to 1 year from date of purchase. If the product fails within the warranty period, please contact Feit Electric at feit.com/help for help. REPLACEMENT OR REFUND IS YOUR SOLE REMEDY. EXCEPT TO THE EXTENT PROHIBITED BY APPLICABLE LAW, ANY IMPLIED WARRANTIES ARE LIMITED IN DURATION TO THE DURATION OF THIS WARRANTY. LIABILITY FOR INCIDENTAL OR CONSEQUENTIAL DAMAGES IS HEREBY EXPRESSLY EXCLUDED. Some states and provinces do not allow the exclusion of incidental or consequential damages, so the above limitation or exclusion may not apply to you. This warranty gives you specific legal rights, and you may also have other rights which vary from state to state or province to province.

Radiation Exposure Statement

This device complies with FCC radiation exposure limits set forth for an uncontrolled environment. This device should be installed and operated with a minimum distance of 20cm between the radiator and your body.

MODEL: TAPETV85/RGB/AG



TV LED Color Sensor Backlight

Quick Install Guide

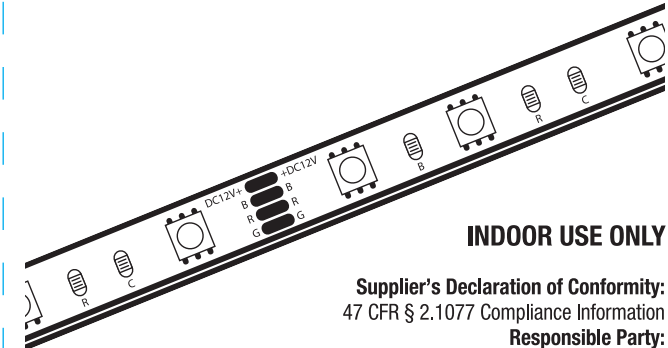

INDOOR USE ONLY

Supplier's Declaration of Conformity:
47 CFR § 2.1077 Compliance Information

Responsible Party:

Feit Electric Company
4901 Gregg Road,
Pico Rivera, CA 90660, USA
562-463-2852
Unique Identifier:
TAPETV85/RGB/AG

ELECTRICAL RATINGS:

INPUT: 100-240VAC ONLY,
50/60HZ, 0.3A MAX
OUTPUT: 12VDC,
1.0A 12W

This device complies with part 15 of the FCC Rules. Operation is subject to the following two conditions: (1) This device may not cause harmful interference, and (2) this device must accept any interference received, including interference that may cause undesired operation. Note: This equipment has been tested and found to comply with the limits for a Class B digital device, pursuant to part 15 of the FCC Rules. These limits are designed to provide reasonable protection against harmful interference in a residential installation. This equipment generates, uses and can radiate radio frequency energy and, if not installed and used in accordance with the instructions, may cause harmful interference to radio communications. However, there is no guarantee that interference will not occur in a particular installation. If this equipment does cause harmful interference to radio or television reception, which can be determined by turning the equipment off and on, the user is encouraged to try to correct the interference by one or more of the following measures: Reorient or relocate the receiving antenna. Increase the separation between the equipment and receiver. Connect the equipment into an outlet on a circuit different from that to which the receiver is connected. Consult the dealer or an experienced radio/TV technician for help. Any changes or modifications not expressly approved by the manufacturer could void the user's authority to operate the equipment. www.feit.com.

Getting Started:

WARNING:

These products may represent a possible shock or fire hazard if improperly installed or attached in any way. Products should be installed in accordance with this install guide, current electrical codes and/or the current National Electric Codes.

CAUTION:

1. Route and secure cords that they will not be pinched or damaged when furniture is pushed to the wall.
2. When mounting lights on furniture ensure lamp caution remains visible.
3. Not intended for recessed installation in ceilings.
4. Electrical codes do not permit cords to be concealed where damage to insulation may go unnoticed.

To prevent fire danger, do not run cord behind walls, ceilings, soffits, or cabinets where it may be inaccessible for examination. Cords should be visually examined periodically and immediately replaced when any damage is noted. This lamp will not operate properly when connected to a dimmer or dimming control.

1 Download the Feit Electric App on your Smart Device



2 Connect the Controller Module

Connect the strip light to the controller module and connect the power outlet to the module by connecting the RCA male and female connectors.

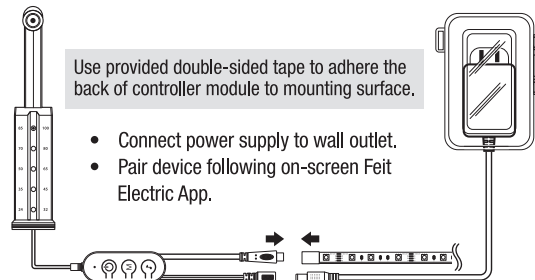

Note: To activate smart features, press and hold the controller module button down for 5 seconds while the unit is off to enter pairing mode. If you need to restart pairing, repeat the process.

3 Prepare the Strip Light

- Measure the desired length before installation.
- Clean the mounting area thoroughly (surface must be free of dust, dirt or grease).
- Avoid bending the strip light which may damage the LEDs.
- Avoid removing and relaying the strip light multiple times as the adhesive may wear off.



Do not bend at LED

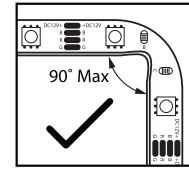
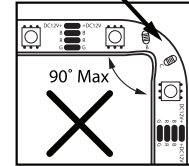

4 Mount the Strip Light

Unroll strip light and place near mounting location. Ensure power supply and controller can reach to the start of the strip light. Do not connect to power yet.

- Attach sensor top the brim (sensor should be center aligned) of your television.
- Peel adhesive tape from back of strip light to position strip light on mounting surface.



This strip light uses permanent tape and may cause surface damage if removed. Not recommended for mounting on brick or concrete.

Feit Electric is not responsible for damage to mounted surfaces.

- Ensure the power supply is not plugged in at the wall outlet when mounting or cutting.
- **Cut to length ONLY on the line or solder pads on strip light**, where the copper or silver metal is visible. Cutting at any other area will permanently damage the strip.

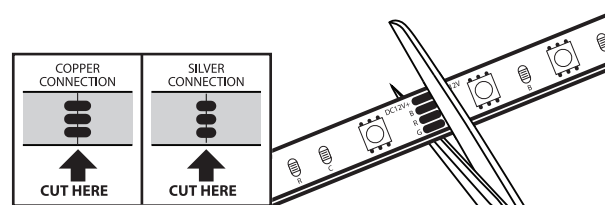

Once cut, the portion of the strip light that will not connect to the controller can be disposed of in accordance with local recycling or waste regulations.

5 Turn on Bluetooth and Open the Feit Electric APP to Complete the Set Up.

Tap **Add Device** or the + sign. The device name(s) will pop up on the Feit app. Tap on **Go to add**, then select the device to add.

Only one device may be added at a time using Bluetooth set up. Repeat Step 5 to add additional devices. Alternative setup options and help instructions are available in the Feit Electric app.

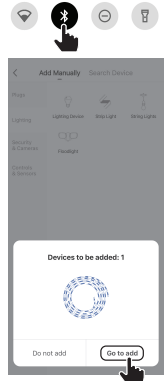

6 Custom Color Changing and Dimming

Drag the circle on the color wheel to change the color. Or under Classic Color, tap your desired color.

Slide left or right to adjust the brightness.

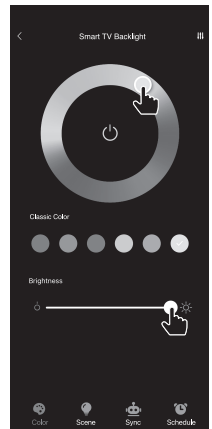

7 Scene

Tap the Scene icon in the bottom of the screen. Select a DIY option Dinner Mode, Romantic Mode, Entertainment Mode or Party Mode from the top of your screen.

