



Installation, Use, & Care Manual

Self-contained Wine Cooling Units

WM-1500SLIM, WM-1500SLIM-TE

WM-2500SLIM, WM-2500SLIM-TE

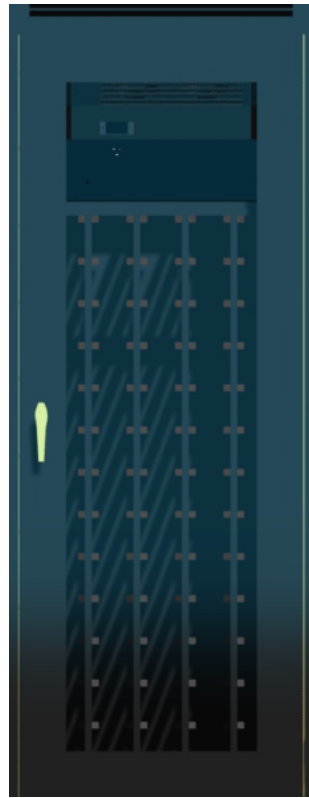

- Features & Specifications - 3**
- Installation Instructions - 5**
- Temperature and Humidity - 12**
- Care Guide - 18**
- Troubleshootings - 19**
- Electrical Wiring Diagrams - 22**
- Customer Support - 25**
- Warranty - 26**

Read and save these instructions

SAFETY INSTRUCTIONS

Electrical Safety

DANGER	Improper use of the power cord plug can result in the risk of electrical shock, property damage and personal injury or death. Unplug the unit or disconnect power before performing any maintenance. Upon receipt and inspection of the unit the power cord must be replaced if it is damaged.
---------------	--

- This product is equipped with a 3-prong grounding-type plug and shall be plugged into a properly connected grounding-type outlet.
- It is required to use a 3-prong grounding-type electrical outlet properly grounded in accordance with the National Electrical Code and local codes and ordinances.
- A separate adequately fused and grounded circuit shall be used for this unit. The voltage rating must match the rating label on the unit.
- Do not use an adapter or an extension cord.
- Do not use a ground fault interrupter (GFI).
- Do not under any circumstances cut or remove the third ground prong from the power cord.
- Never unplug the unit by pulling the power cord. To disconnect the unit always grip the plug firmly and pull straight out from the wall outlet.
- Do not operate the unit if the unit housing is removed or damaged.
- Do not attempt to repair or replace any part of your unit unless it is specifically recommended in this manual. All other servicing shall be referred to a qualified technician.
- Unplug the unit or disconnect power before performing any maintenance.
- To protect against electric shock do not immerse unit plug or cord into water or other liquids.
- Do not operate the unit with wet hands, while standing on a wet surface, or while standing in water.

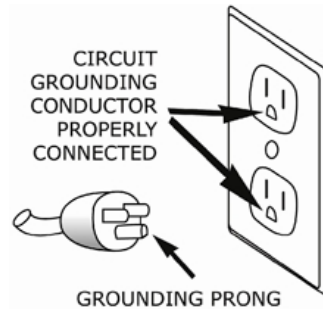

Disposing Safety

CAUTION	When disposing of refrigeration products, special handling is often required. It is the consumer's responsibility to comply with federal and local regulations when disposing of this product.
----------------	--

Features and Specifications

- WM-1500SLIM & 1500SLIM-TE and WM-2500SLIM & 2500SLIM-TE cooling units are designed to provide a subtle temperature between 50~65 °F for a properly insulated wine cabinet.
- The refrigerated space will maintain humidity range within 50~70% RH.
- These temperature and humidity ranges are optimized for long term storage of wine.
- Temperature is controlled and humidity is adjusted using patented technology.
- Innovatively designed cold air curtain keeps even temperatures everywhere in the cabinet.
- Multiple options for top or rear hot air exhaust are convenient for flexible installations.
- Patented condensate drain tray is used for humidity adjustment.
- The unit is self-contained ready for easy installation and use.

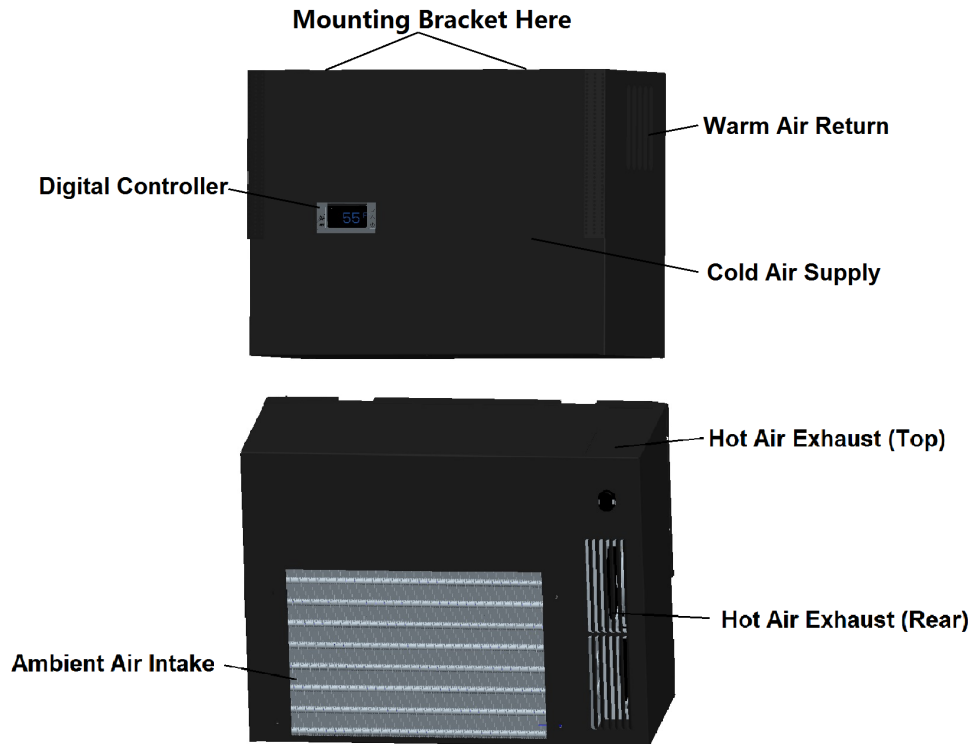

Fig. 1.1 Feature Descriptions

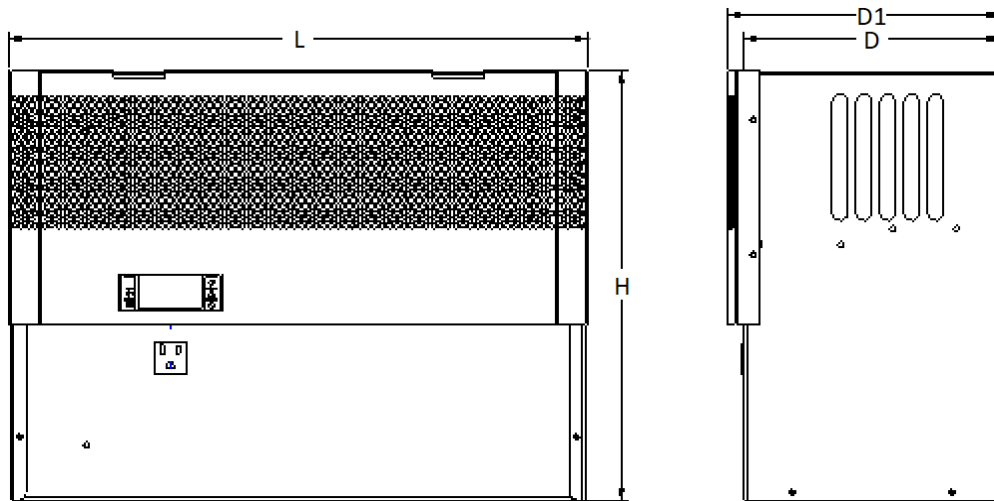

Fig. 1.2 Dimensions

The specifications are listed as follows:

Model No	Exhaust	Dim (in) L x D x D1 x H	Airflow (CFM)	Cabinet Size (cu ft)	Electrical Rating	Weight (lb)
WM-1500SLIM	Rear	18 x 8 x 8-1/2 x 13-1/2	120	90	115V-60Hz-3A	40
WM-1500SLIM-TE	Top	18 x 8 x 8-1/2 x 13-1/2	120	90	115V-60Hz-3A	40
WM-2500SLIM	Rear	18 x 8 x 8-1/2 x 13-1/2	180	200	115V-60Hz-4A	45
WM-2500SLIM-TE	Top	18 x 8 x 8-1/2 x 13-1/2	180	200	115V-60Hz-4A	45

NOTE	<p>See the voltage, frequency, current and refrigerant specified on the label of the cooling unit.</p> <p>The rated cooling capacity is determined under the cabinet and ambient temperatures of 55°F and 75°F with R13 interior and R19 exterior insulation. Higher ambient temperatures and less insulation will cause reducing the capacity.</p>
-------------	---

Installation Instructions

NOTE	Mounting brackets, screws, gaskets and other seal materials are not included. Do not install any ducts onto the supply, return, intake and exhaust.
-------------	--

NOTE	Do not plug the unit into power until 24 hours after delivery.
-------------	--

CAUTION	A dedicated 20 AMP circuit is required. Because of potential safety hazards under a certain condition, we strongly recommend against the use of an extension cord. However, if you still elect to use an extension cord, it is absolutely necessary that it will be a UL LISTED 3-wire grounding type extension cord having a 3-blade grounding plug and a 3-slot receptacle that will plug into the unit. The marked rating of the extension cord shall be 115 V, 15 A.
----------------	---

1. Cabinet Location

- Place the wine cabinet in a properly ventilated location. Otherwise, heat exhausted by the cooling unit will build up and may cause the cooling unit not to work properly.
- The exhaust area must not be a closed space and must be ventilated.
- The ambient temperatures shall not be higher than 78°F for running WM-1500SLIM & 1500SLIM-TE or 95°F for running WM-2500SLIM & 2500SLIM-TE and shall not be lower than 50 °F for all units.

1) Rear Exhaust Cabinet

- Leave min 6 "clearance at the rear.
- Leave min 12" clearance at the top.
- Leave min 6" clearance at both sides.

2) Front Exhaust Cabinet

- Leave min 6" clearance at the front if the sides are unobstructed.
- Or, leave min 36" clearance at the front if the sides are obstructed

3) Top Exhaust Cabinet

- Leave min 12" clearance at the top.
- Leave min 2 "clearance at the rear.
- Leave min 2" clearance at both sides.

4) Side Exhaust Cabinet

- Leave min 6 "clearance at the side of hot air exhaust.
- Leave min 12" clearance at the top.

2. Cooling Unit Installation

- The cooling unit produces cooling that is supplied into the cabinet, meanwhile it also generates heat that must be exhausted outside the cabinet. So both the cold-air supply and warm-air return must be separated from both the hot-air exhaust and ambient-air intake. Foam tape gasket may be used to seal them. The cooling unit must intake adequate fresh ambient-air to work properly. The ambient-air intake and hot-air exhaust must not be short-circuited.

1) Making Cutouts

- Make a rectangular through hole on the rear or front wall of the cabinet with 7/8" less than the width and height of the cooling unit. Make 1/2" wide lips to place the gaskets as shown in Fig. 2.1.
- If it is a top exhaust installation, make an additional rectangular hole on the top wall of the cabinet with the same length and width of the top air exhaust as shown in Fig. 2.2.
- Install 2 pieces of 1/4" ID wood thread inserts on the ceiling as shown in Fig. 2.3.
- Install the rear gaskets (1/2" foam tape) on the lips as shown in Fig. 2.4.
- If it is a top exhaust installation, install additional top gaskets on the cooling unit as shown in Fig. 2.5.

2) Installing Cooling Unit

- Push the cooling unit towards the lips until it stops and press the gaskets as shown in Fig. 2.6.
- Use 2 pieces of mounting brackets and 2 pieces of 1/4" screws to secure the cooling unit as shown in Fig. 2.6. You need a 7/16" wrench.
- The air supply shall not be obstructed 12" and the air return shall not be obstructed 2" inside the cabinet.
- The complete rear exhaust and top exhaust installations are shown in Fig. 2.7 and Fig. 2.8.

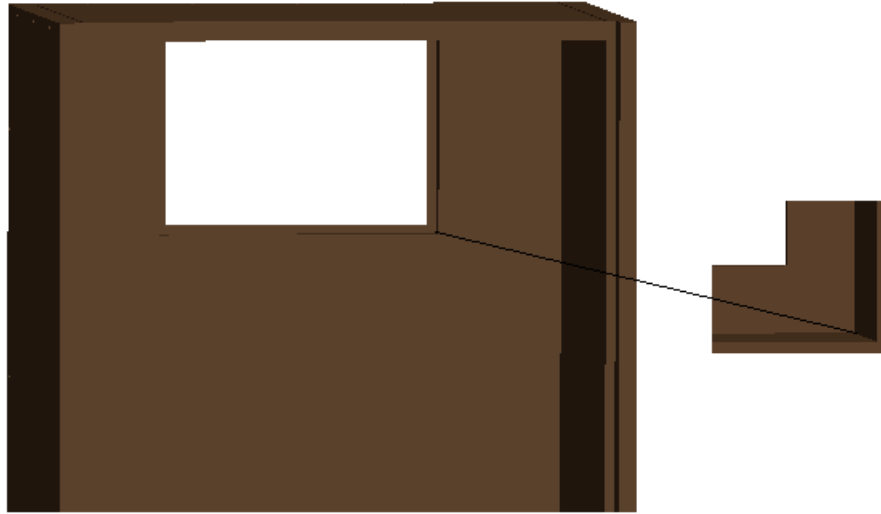

Fig. 2.1 Rear Cutout

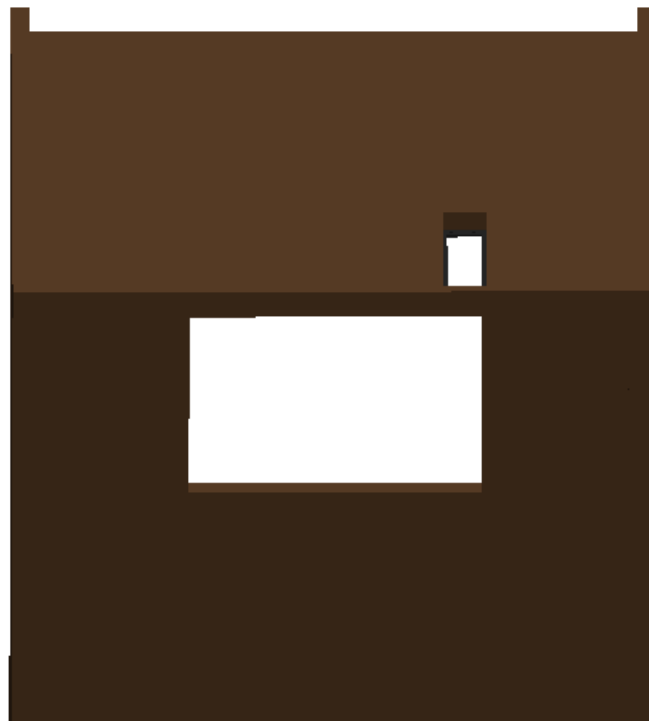

Fig. 2.2 Additional Top Cutout

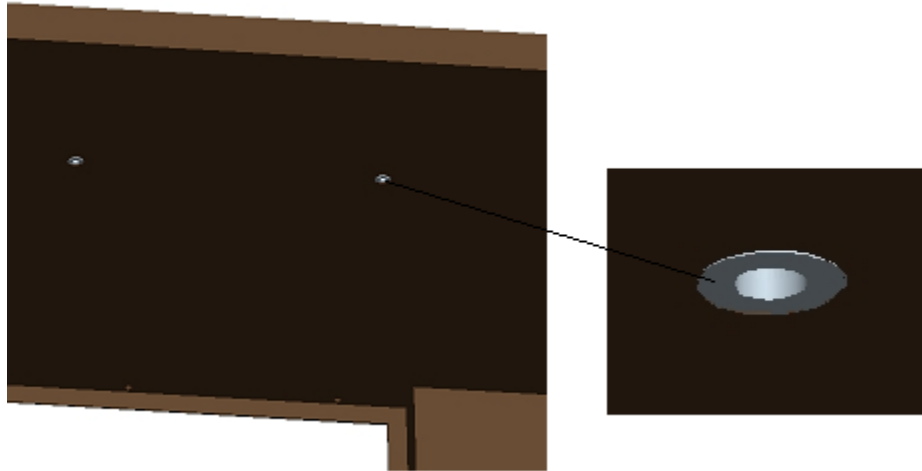

Fig. 2.3 Installing Thread Inserts

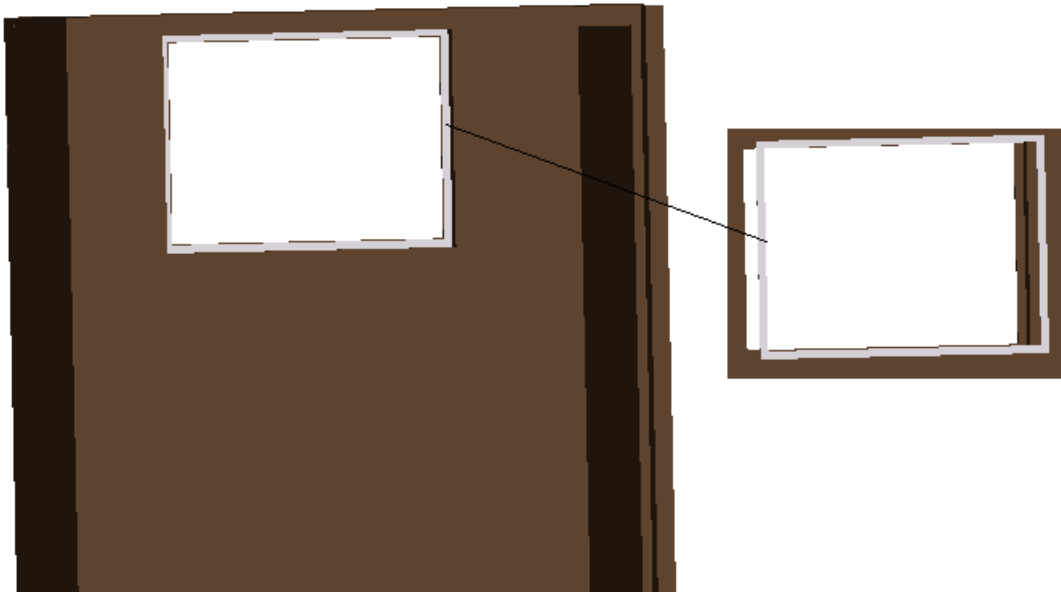
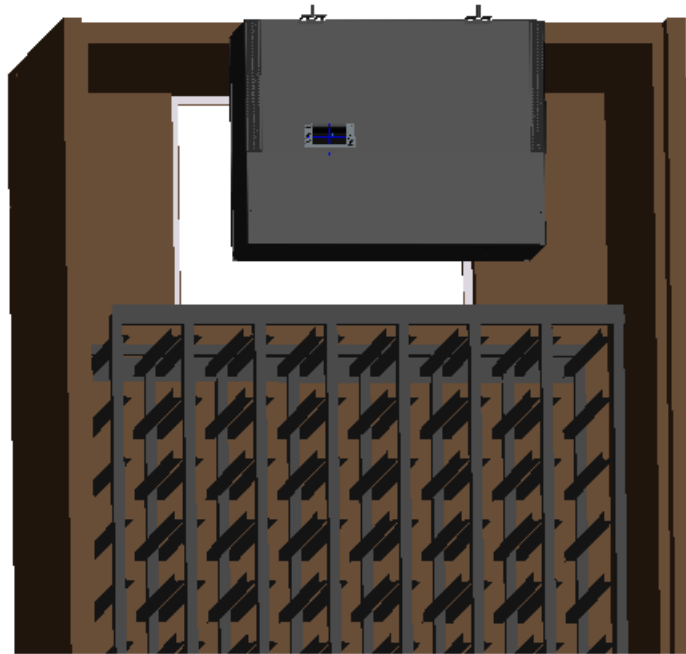

Fig. 2.4 Rear Gaskets

**GASKET
(TOP EXHAUST)**



Fig. 2.5 Top Gaskets



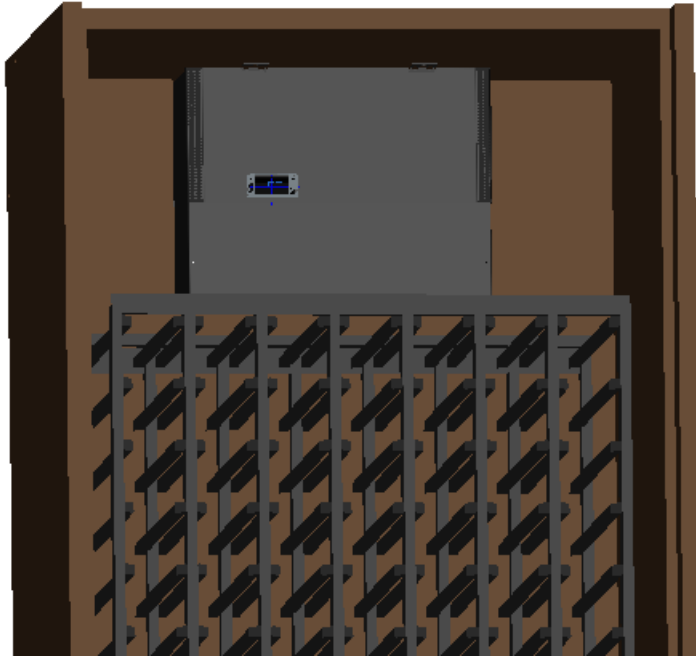

Fig. 2.6 Installing Cooling Unit

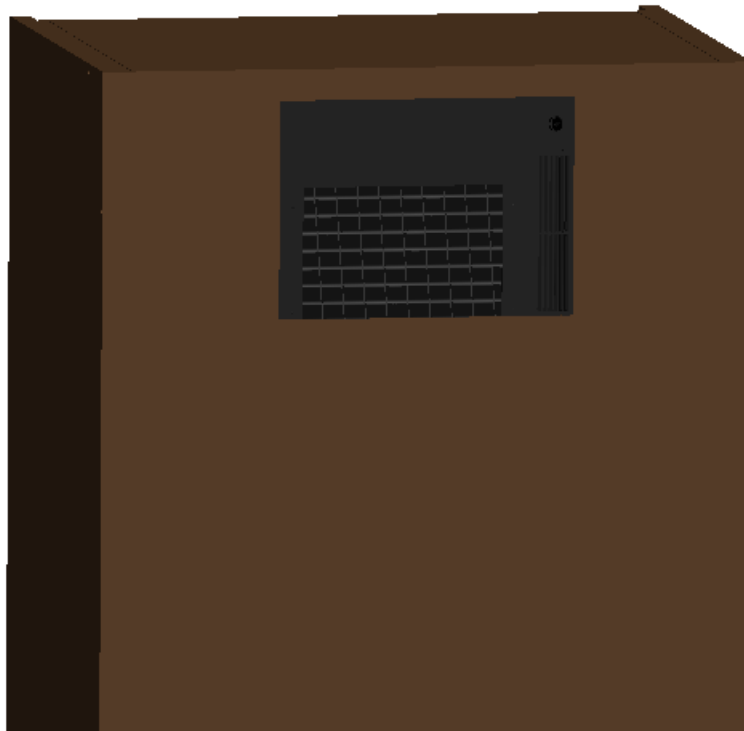

Fig. 2.7 Cooling Unit Installed (Rear Exhaust)

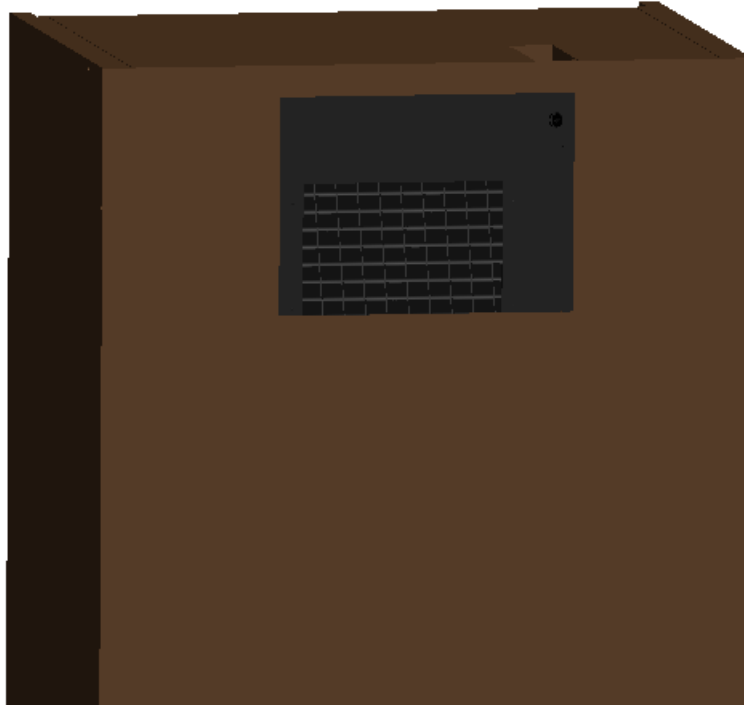

Fig. 2.8 Cooling Unit Installed (Top Exhaust)

Temperature and Humidity Control

1. The controller



Temperature Controller

1.1 Keypad

⏻: To turn on/off the power to the unit.

SET: To display set-point; to select a parameter or confirms an operation in programming mode.

▲: To browse the parameter codes or increase the displayed values in the programming mode.

▼: To browse the parameter codes or decrease the displayed values in the programming mode.

❄️: To start or stop manual defrost.

1.2 Display

During normal operations conditions, the display shows the value measured by the room probe. In case of active alarm, the temperature flashes alternately to the alarm codes. The LED functions are listed as follows.

LED	MODE	FUNCTION
❄️	ON	Compressor enabled
❄️	Flashing	Anti-short cycle enabled
❄️	ON	Defrost cycle enabled
❄️	Flashing	Dripping time enabled
🌀	ON	Fan enabled
🌀	Flashing	Fan delay after defrost enabled
🔔	ON	Alarm occurring
°C/°F	ON	Temperature measuring unit
°C/°F	Flashing	Programming mode

1.3 Alarm Signals

The alarm codes are described as follows.

MESSAGE	CAUSE	FUNCTION
P1	Room probe faulty	Compressor switching to Con and CoF
HA	Room probe temperature higher than the set- point + ALU	Outputs unchanged
LA	Room probe temperature lower than the set-point - ALL	Outputs unchanged
CA	External alarm	All outputs off

Probe alarms P1” start a few seconds after the probe fault in the related probe; they automatically stop a few seconds after the probe restarts normal operation. Check connections before replacing the probe. Temperature alarms “HA” and “LA” automatically stop as soon as the temperature returns to normal value. Alarm “CA” (with i1F=PAL) recovers only by switching off and on the controller.

2. How to operate the controller

2.1 Lock and unlock the keypad

To lock the keypad, press and hold ▲+▼ keys until POF is displayed; to unlock the keypad, press and hold ▲+▼ keys until PON is displayed.

2.2 How to see temperature set-point

Press the **SET** key once, the display will show the set-point value, press the **SET** key once again to display the probe value.

2.3. How to change the set-point

- 1) Press and hold the **SET** key until the “°C” or “°F” LED starts flashing and the set-point is displayed.
- 2) Press ▲ or ▼ key to change the set-point value within 10 sec.
- 3) Press the **SET** key once again to store the new set-point value.

NOTE:

- The unit turns on at set-point plus regulation differential **H_y** after anti-short cycle **AC** has elapsed; the unit turns off at set-point.
- Set the temperature at 55 °F for the optimum aging of wine.

- On initial start-up, the time required to reach the desired temperature will vary, depending on the quantity of bottles, temperature setting and surrounding temperature.
- Allow 24 hours to stabilize the temperature for a new temperature setting.

2.4. How to calibrate the room probe

If the actual cellar temperature differs from the setting temperature, set parameter **ot** = actual cellar temperature minus set-point.

2.5. How to use bottle probe

Enable bottle probe:

PARAMETER	DESCRIPTION	VALUE
P3P	Third probe presence	y
O3	Third probe calibration	0
Lod	Controller display	P3

Disable bottle probe:

PARAMETER	DESCRIPTION	VALUE
P3P	Third probe presence	n
O3	Third probe calibration	0
Lod	Controller display	P1

2.6 How to adjust defrost cycle

In case there is excessive frost, the parameters **FnC** = C-y, **idF** = 4 and **MdF** = 20 can be used to avoid frost.

2.7 How to adjust the humidity

The parameter **Fon** is used to adjust the humidity in the wine cellar. Higher **Fon** results in higher relative humidity. Use a separate hygrometer to monitor the humidity.

2.8 How to set alarm call

2.8.1 Controller Program

1) A voice notice will be sent to your phones when the cellar temperature is higher than set-point plus **ALU** or lower than set-point minus **ALL**.

2) In order to test the call function, set parameters **Ald** = 0 and **dAO** = 0. After testing, reset **Ald** = 60 and **dAO** = 23.

2.8.2 Dialer Program

- 1) To program the numbers to be called, press **PROG** **1** **#**
- 2) After the dial LED flashes twice, enter the phone number to call.
- 3) To finish, press **#**

Example:

PROG **1** **#** **5** **5** **5** **1** **2** **1** **2** **#** - this would dial phone number **555-1212** and deliver the message programmed for **zone 1**.

- 4) When the auto dialer is activated to dial, the red **DIAL** will stay on.

2.8.3 Wiring Diagram

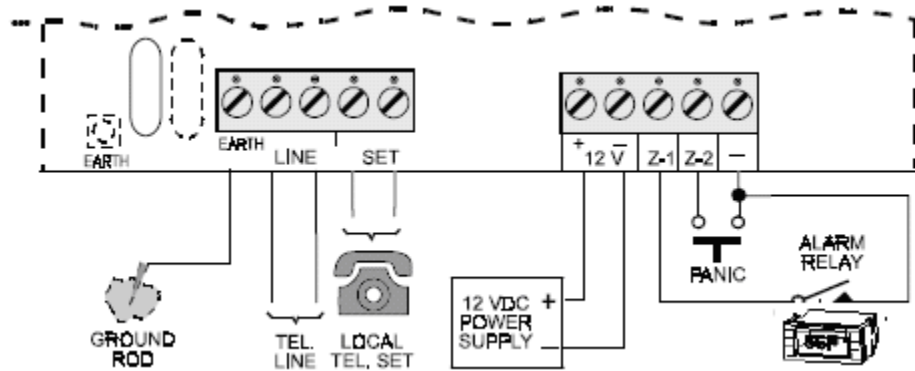

2.9 How to set the anti-freezing heater

The heater turns on at the set-point **SAA** minus **Shy**; the heater turns off at the set-point **SAA**.







NOTES:

- Use a forced air heater to warm up the wine cellar.
- If there is a thermostat on the heater, bypass it or set the thermostat at the highest level.
- If the heater runs more than 10 A current, use a 120VAC coil contactor

3. Manual Defrost

Press and hold the defrost  key until defrost starts. The defrost indicator will be on.

4. Parameter Programming

- 1) Press and hold the **SET** +  keys until the “°C” or “°F” LED starts flashing.
- 2) Press and hold again the **SET** +  keys until the **Pr2** label is displayed. The first parameter **Hy** will be displayed.
- 3) Press  or  key to scroll to the required parameter within 10 sec.
- 4) Press the “**SET**” key once to display its value.
- 5) Press  or  key to change its value within 10 sec.
- 6) Press **SET** key once to store the new value and the display will flash 3 times.
- 7) Press **SET** +  to exit or wait 15sec without pressing a key.

PARAMETER	DESCRIPTION	DEFAULT VALUE
	set-point (°)	55
Hy	temperature regulation differential (°)	4
AC	anti-short cycle delay (min)	10
Con	compress on with probe faulty (min)	20
CoF	compress off with probe faulty (min)	20
CF	temperature unit (°F/°C)	F: Fahrenheit
rES	display resolution	in: integer
dLy	temperature display delay (min)	1
ot	probe calibration (°)	0
LS	minimum set-point (°)	50
US	maximum set-point (°)	65
idF	defrost cycle interval time (hour)	12
MdF	defrost cycle endurance time (min)	30
ALC	temperature alarm type	rE: relative to set-point
ALU	high temperature alarm (°)	10
ALL	low temperature alarm (°)	10
AFH	alarm recovery differential (°)	5
ALd	temperature alarm delay (min)	60
dAo	temperature alarm delay on startup (hr)	23
SAA	heater set-point (°)	40
SHy	heater regulation differential (°)	4
FSU	fan action	Std
FnC	fan operating mode C-n: on with compressor & off during defrost C-y: on with compressor & on during defrost O-n: on all the time & off during defrost O-y: on all the time & on during defrost	C-n
Fon	fan on with compressor off (min)	0
FoF	fan off with compressor off (min)	15



PARAMETER	DESCRIPTION	DEFAULT VALUE
-----------	-------------	---------------

	set-point (°)	13
Hy	temperature regulation differential (°)	2
AC	anti-short cycle delay (min)	10
Con	compress on with probe faulty (min)	20
CoF	compress off with probe faulty (min)	20
CF	temperature unit (°F/ °C)	C: Celsius
rES	display resolution	in: integer
dLy	temperature display delay (min)	1
ot	probe calibration (°)	0
LS	minimum set-point (°)	5
US	maximum set-point (°)	20
idF	defrost cycle interval time (hour)	12
MdF	defrost cycle endurance time (min)	20
ALC	temperature alarm type	rE: relative to set-point
ALU	high temperature alarm (°)	5
ALL	low temperature alarm (°)	5
AFH	alarm recovery differential (°)	2
ALd	temperature alarm delay (min)	60
dAo	temperature alarm delay on startup (hr)	23
SAA	heater set-point (°)	4
SHy	heater regulation differential (°)	2
FSU	fan action	Std
FnC	fan operating mode C-n: on with compressor & off during defrost C-y: on with compressor & on during defrost O-n: on all the time & off during defrost O-y: on all the time & on during defrost	C-n
Fon	fan on with compressor off (min)	0
FoF	fan off with compressor off (min)	15

NOTE:

Depending on the controllers and applications, not all parameters are applied.

Care Guide

 WARNING	
	ELECTRIC SHOCK HAZARD Disconnect the electrical power before servicing any components. Failure to do so can result in death or electrical shock.

1. Cleaning Condenser

- 1) Clean the condenser regularly at least every 6 months.
- 2) Condenser is located on the ambient air intake side of the cooling unit.
- 3) Use a condenser brush or a vacuum cleaner with an extended attachment to clean the condenser.

2. Removing Condensate

Remove the excessive condensate if it is accumulated on the cooling unit in high humidity conditions.

3. Removing Unit

When you remove the cooling unit, beware water may come out of the unit.

Troubleshootings

This Troubleshooting Chart is not prepared to replace the training required for a professional refrigeration service person, not is it comprehensive

Complaint	Possible Causes	Response
1. Unit not running	Power cord not plugged No power from supply Incorrect or loose wirings Low voltage Setting higher than ambient temperature Cut-in too high Defrost light blinking Compressor light blinking Defective controller	Check power cord Check receptacle and fuses Check all wirings and connections Contact an authorized electrician Lower temperature setting Reduce Hy Unit is under defrost mode Unit is under anti-short cycle delay Call service for diagnosis
2. Unit not starting , but temperature rising high	Anti-short cycle	Reset AC
3. Temperature fluctuating	Air probe	When using an air probe, the wine bottle temperature is mainly controlled by the average air temperature. If the set-point is 55°F with the differential 4F, the cooling unit turns on at 59°F of air temperature (It may be higher than 59°F if it is in anti-short cycle or defrost cycle) and turns off at 55°F of air temperature. The average air temperature is 57°F, and then the wine temperature is around 57+/-0.5°F. The air is light enough to change so quickly that it maintains relatively constant average temperature that would prevent wine bottle temperature from fluctuating.
4. Temperature high, unit stopping and starting normally	Temperature setting high	Lower the setting
5. Temperature high, unit stopping and starting with short running time	Air probe touching the evaporator coil, displaying temperature ok Short circuit of air flow between cold-air supply and cellar-air return, displaying temperature ok Failed controller and probe	Move the air probe away from the evaporator Deflect the supply air down Call service for diagnosis
6. Temperature	Improper cellar insulation & seal	Check insulation, gasket and door opening,

<p>high or not cooling and running continually</p>	<p>Cellar too large Ambient temperature too high Exhaust restricted</p> <p>Malfunctioning fans</p> <p>Evaporator or condenser airflow</p> <p>Dirty Condenser Iced evaporator Refrigeration system restriction Refrigerant leak Undercharge or overcharge Failed components</p>	<p>power cord grommet Check for excessive size Check installation location Leave minimum 3 feet clearance for the hot air exhaust side and leave minimum 1 foot clearance for the fresh air intake side Check for both evaporator and condenser fans Check for air restrictions, air short-circulation, grille directions Clean condenser Defrost and reset temperature Call service Call service Call service Check compressor windings, start relay and overload protector</p>
<p>7. Unit running too long</p>	<p>Improper cellar insulation & seal</p> <p>Cellar too large Ambient temperature higher > 90°F Exhaust restricted</p> <p>Dirty Condenser Improper condenser air flow</p>	<p>Check insulation, gasket and door opening, power cord grommet Check for excessive size Check for installation location</p> <p>Leave minimum 3 feet clearance for the hot air exhaust side and leave minimum 1 foot clearance for the fresh air intake side Clean condenser Check for fan and air short circulation</p>
<p>8. Fan motor running but compressor not running</p>	<p>Post-compressor fan running mode Incorrect or loose wirings Failed components</p> <p>Liquid refrigerant in the compressor</p>	<p>Check fan running time FON</p> <p>Check all wirings and connections Check start relay, start capacitor, overload protector, compressor. Call service.</p>
<p>9. Compressor running but fan not running</p>	<p>Fan blade stuck Incorrect or loose wirings Failed motors</p>	<p>Check for proper clearance Check all wirings Call service</p>
<p>10. Temperature high, compressor stopping and starting but very short running time</p>	<p>Failed components</p> <p>Improper condenser airflow Dirty condenser Overcharge of refrigerant Discharge or suction pressure too high</p>	<p>Check compressor windings, start relay and overload protector. Check for condenser fan Clean condenser Call service for removing refrigerant Call service for information</p>
<p>11. Fan running too long</p>	<p>Post-compressor fan running mode for humidity modulation</p>	<p>Reset FON</p>

12. Temperature low	Low temperature setting Low ambient temperature Air probe fault Temperature controller fault	Raise the setting Move to another location Change a new one Change a new one
13. Evaporator freezing up	Evaporator air flow restriction Low temperature setting Low ambient temperature Defective controller or probe Not stopping due to air leak, high ambient temperature, condenser air flow restriction or pull-down cooling Initially working then stopping, moisture in the system Refrigerant low or leaking Capillary tube or expansion valve blockage	Check for fans and air flow Check for set-point Change defrost cycle Check for controller and probe Check for seal, door opening, ambient temperature and condenser air flow Call service Call service Call service
14. Water leak	Air leak in the wine cellar causing excessive condensate High humidity causing excessive condensate Evaporator air flow restriction Water passages restricted Drip tray leak (No water overflow but water leak)	Check for air leak Use drain line Check supply air flow or air TD Clean the drip tray Seal the leak using silicone sealant
15. Excessive condensate in wine cellar	Air leak in the wine cellar causing excessive condensate High humidity causing excessive condensate Water passages restricted	Check for any air leak Use drain line Clean the drip tray
16. Circuit tripping	Incorrect fuse or breaker Incorrect wirings Failed components	Check for proper fuse or breaker Check for wirings and connections Call service
17. Noisy operation	Mounting area not firm Loose parts Compressor overloaded due to high ambient temperatures or airflow restriction Defective components	Add support to improve installation Check fan blades, bearings, washers, tubing contact and loose screws. Check for airflow Call service for checking internal loose, inadequate lubrication and incorrect wirings

Electrical Wiring Diagrams

1. XR30CX Self-contained Wiring Diagram

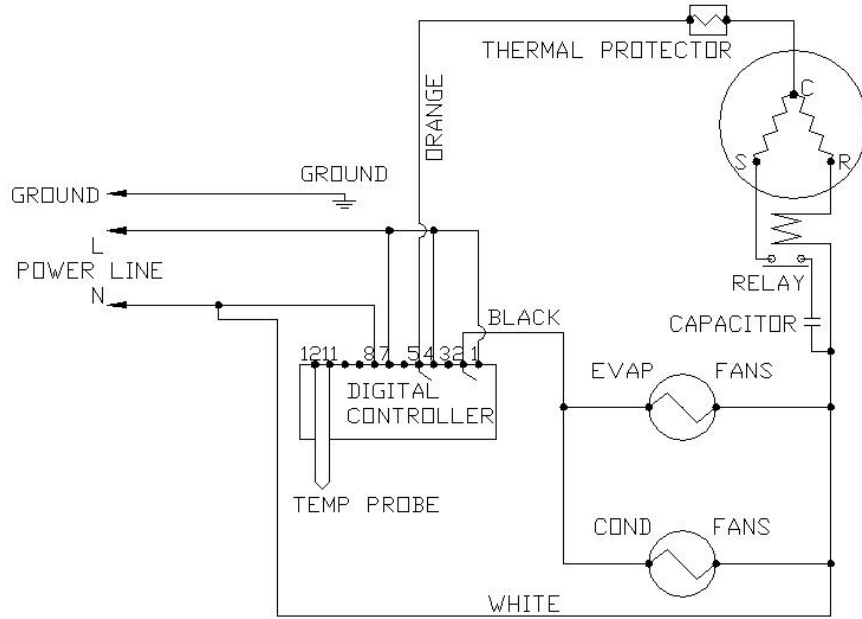

2. XR50CX Bottle Probe Wiring Diagram

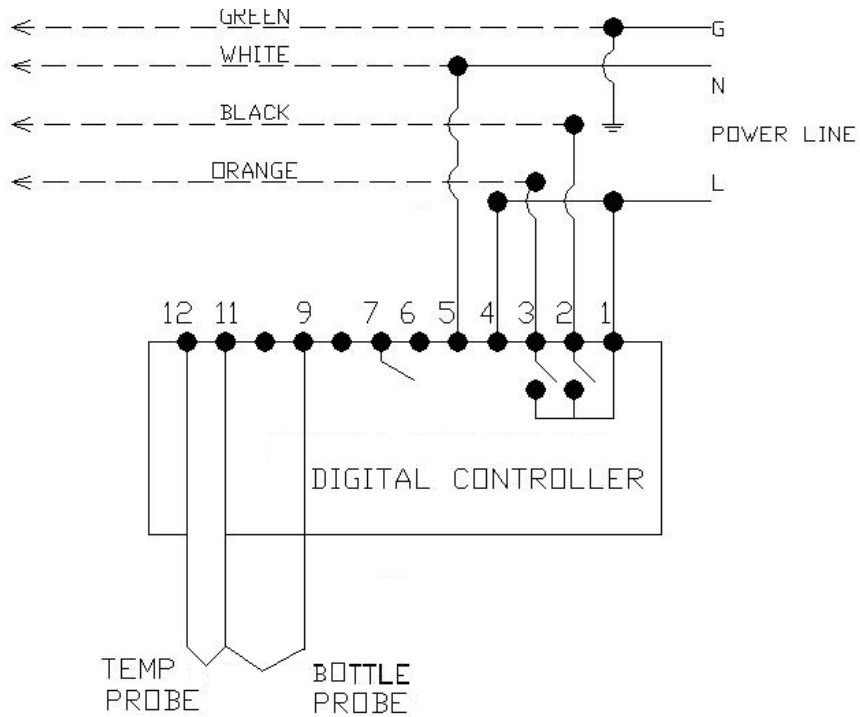

3. XR50CX Alarm Wiring Diagram

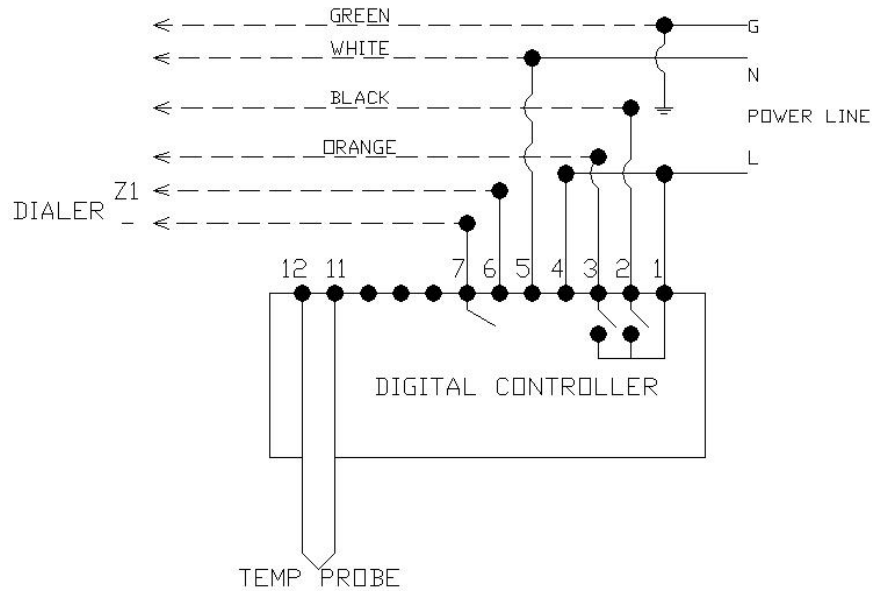

4. XR50CX Heater Wiring Diagram

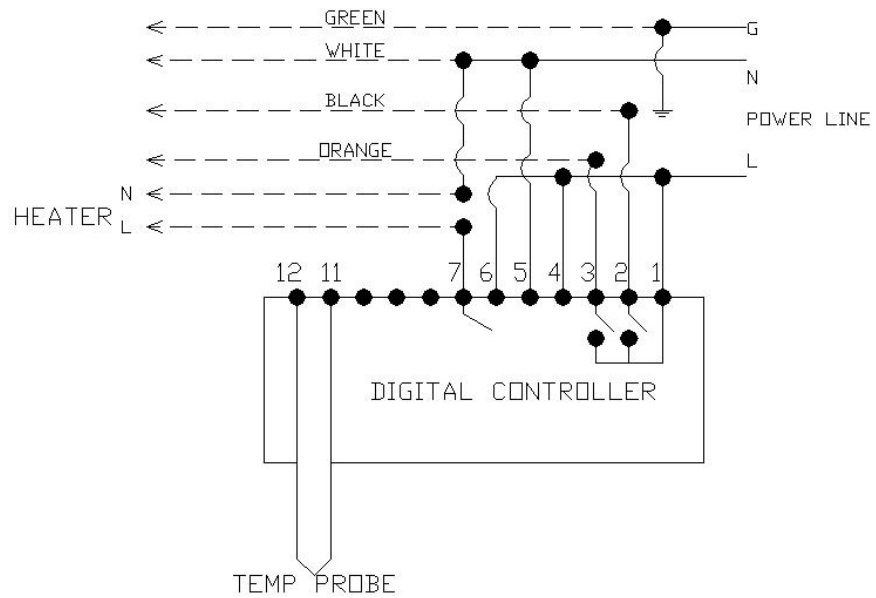

5. XR70CX Heater and Caller Wiring Diagram

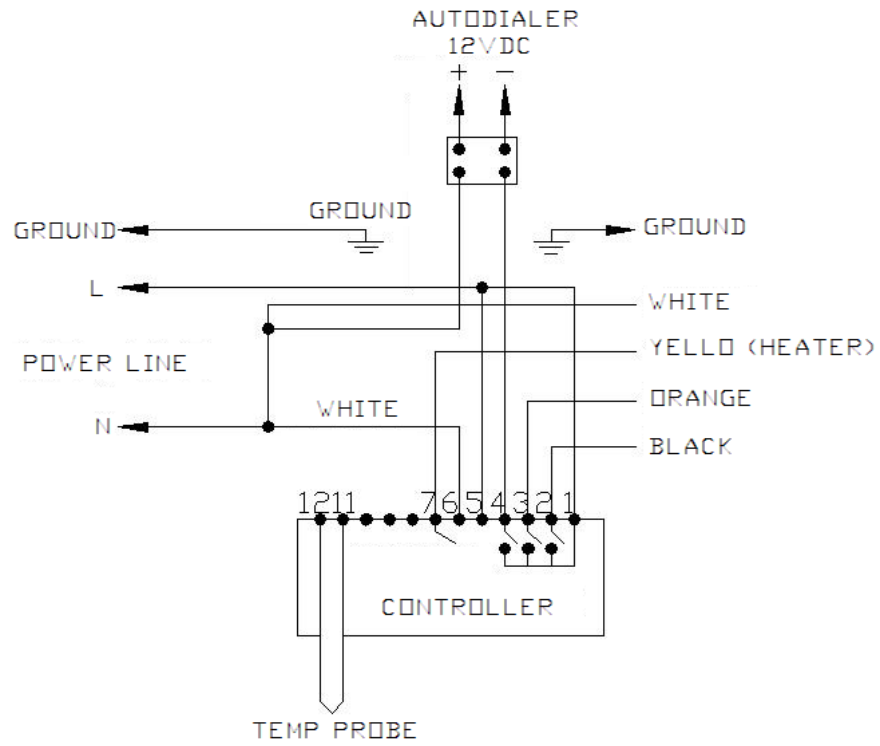

Customer Support

If you need further assistance, please contact Vinotemp at:

Email: info@vinotemp.com

Warranty

Thank you for choosing a Vinotemp's cooling unit.

Please enter the complete model and serial numbers in the space provided:

Model _____
Serial No. _____

Attach your purchase receipt to this owner's manual.

1. Limited Warranty

VINOTEMP warrants its products to be free from defects due to workmanship or materials under normal use and service, for twelve months after the initial sale. If the product is defective due to workmanship or materials, is removed within twelve months of the initial sale and is returned to VINOTEMP, in the original shipping carton, shipping prepaid, VINOTEMP will at its option, repair or replace the product free of charge. Additionally VINOTEMP warrants all parts to be free from defects for a period of sixty months after initial sale.

This warranty constitutes the entire warranty of the VINOTEMP with respect to its products and is in lieu of all other warranties, express or implied, including any of fitness for a particular purpose. In no event shall VINOTEMP be responsible for any consequential damages what is so ever. Any modification or unauthorized repair of VINOTEMP products shall void this warranty.

Service under Warranty

This service is provided to customers within the continental UNITED STATES only. VINOTEMP cooling units are warranted to produce the stated number of BTU/H. While every effort has been made to provide accurate guidelines, VINOTEMP can not warranty its units to cool a particular enclosure.

In case of failure, VINOTEMP cooling units must be repaired by the factory or its authorized agent. Repairs or modifications made by anyone else will void the warranty.

Shall a VINOTEMP cooling unit fail, please contact the dealer for instructions. Do not return the unit to the factory without authorization from VINOTEMP. If the unit requires repair, re-pack it in the original shipping carton and return it to the factory, shipping

prepaid. VINOTEMP will not accept COD shipments. If the unit is determined to be faulty and is within the twelve month warranty period VINOTEMP will, at its discretion, repair or replace the unit and return it free of charge to the original retail customer. If the unit is found to be in good working order, or beyond the initial twelve month period, it will be returned freight collect.

2. Limitation of Implied Warranty

VINOTEMP'S SOLE LIABILITY FOR ANY DEFECTIVE PRODUCT IS LIMITED TO, AT OUR OPTION, REPAIRING OR REPLACING OF UNIT.

VINOTEMP SHALL NOT BE LIABLE FOR:

DAMAGE TO OTHER PROPERTY CAUSED BY ANY DEFECTS IN THE UNIT, DAMAGES BASED UPON INCONVENIENCE, LOSS OF USE OF THE UNIT, LOSS OF TIME OR COMMERCIAL LOSS, ANY OUTER DAMAGES, WHETHER INCIDENTAL, CONSEQUENTIAL OR OTHERWISE.

THIS WARRANTY IS EXCLUSIBE AND IS IN LIEU OF ALL OTHER WARRANTIES, EXPRESSED OR INPLIED, INCLUDING BUT NOT LIMITED TO, IMPLIED WARRANTIES OF MERCHANTABILITY OR FITNESS FOR A PARTICULAR PURPOSE.

While great effort has been made to provide accurate guidelines VINOTEMP cannot warrant its units to properly cool a particular enclosure. Customers are cautioned that enclosure construction, unit location and many other factors can affect the operation and performance of the unit. There for suitability of the unit for a specific enclosure or application must be determined by the customer and cannot be warranted by VINOTEMP.