

DS-2CE57H0T-VPITF 5 MP Outdoor Analog Dome Camera



- 5 MP (2560 x 1944) Resolution
- 2.8 mm, 3.6 mm, or 6 mm Lens
- Smart IR, 66 ft (20 m) Range
- 4-in-1 Video Output (Switchable TVI/AHD/CVI/CVBS)
- IP67, IK10

The Hikvision DS-2CE57H0T-VPITF 5 MP Outdoor Dome Camera provides high definition analog output with a resolution of up to 2560 x 1944 pixels. TurboHD means that the analog signal can be sent over existing coaxial cable, eliminating the need to run new cables for high definition video.

EXIR 2.0 is Hikvision's proprietary IR extended range technology, which has a range of 66 feet (20 meters).

The 2.8 mm, 3.6 mm, and 6 mm fixed lens options are optimized for viewing angles that fit any situation. DWDR (Digital Wide Dynamic Range) ensures that ideal images are captured regardless of the lighting conditions. The camera also supports TVI, AHD, CVI, and CVBS video signals, and is water, dust and impact-resistant (IP67 and IK10 rated).

Available Models:
DS-2CE57H0T-VPITF







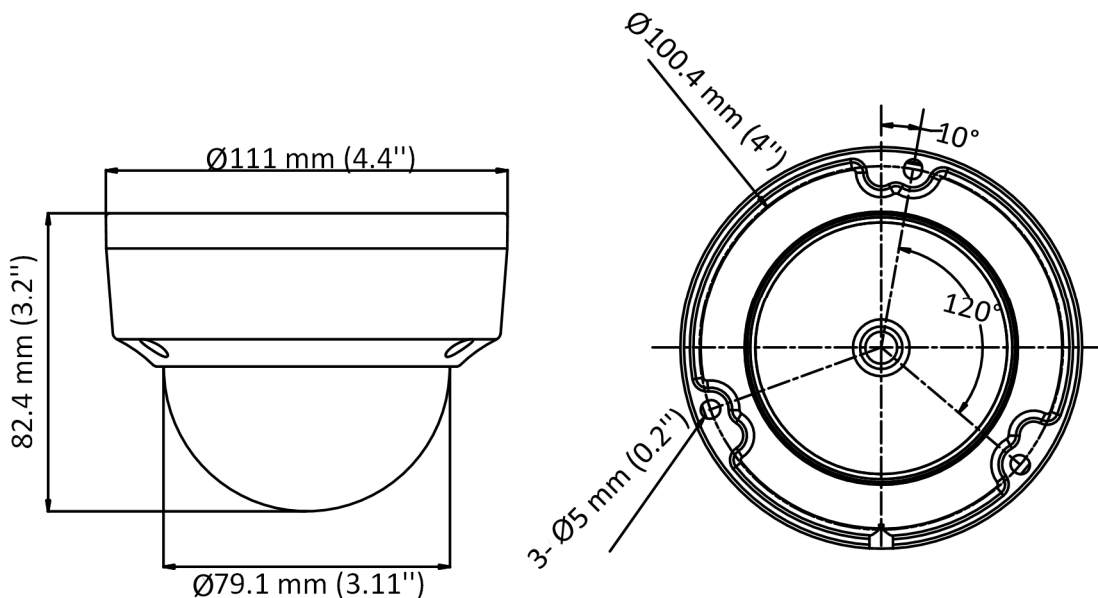

Specifications

DS-2CE57H0T-VPITF	
Camera	
Image Sensor	5 MP CMOS
Signal System	PAL/NTSC
Resolution	2560 (H) × 1944 (V)
Frame Rate	TVI: 5 M @ 20 fps, 4 M @ 30 fps, 4 M @ 25 fps, 1080p @ 30 fps, 1080p @ 25 fps AHD: 5 M @ 20 fps, 4 M @ 30 fps, 4 M @ 25 fps CVI: 4 M @ 30 fps, 4 M @ 25 fps CVBS: PAL/NTSC
Minimum Illumination	0.01 lux @ (f/1.2, AGC on), 0 lux with IR
Shutter Speed	PAL: 1/25 s to 1/50,000 s NTSC: 1/30 s to 1/50,000 s
Lens	2.8 mm, 3.6 mm, 6 mm fixed lens
Field of View	2.8 mm, horizontal FOV: 85°, vertical FOV: 63°, diagonal FOV: 110° 3.6 mm, horizontal FOV: 80°, vertical FOV: 63°, diagonal FOV: 105° 6 mm, horizontal FOV: 57°, vertical FOV: 43°, diagonal FOV: 72°
Lens Mount	M12
Day/Night	ICR
WDR (Wide Dynamic Range)	Digital WDR
Angle Adjustment	Pan: 0 to 355°, tilt: 0 to 75°, rotation: 0 to 355°
Menu	
Image Mode	STD/HIGH-SAT
AGC	Yes
Day/Night Mode	Auto/Color/BW (Black and White)
White Balance	Auto/Manual
AE (Auto Exposure) Mode	DWDR/BLC/HLC/Global
Noise Reduction	2D DNR
Language	English
Function	Brightness, Sharpness, Mirror, Smart IR
Interface	
Video Output	Switchable TVI/AHD/CVI/CVBS
General	
Operating Conditions	-40° to 140° F (-40° to 60° C), humidity 90% or less (non-condensing)
Power Supply	12 VDC ±25%
Power Consumption	Maximum 4.3 W
Protection Level	IP67, IK10
Material	Metal
IR Range	Up to 66 ft (20 m) range
Communication	HIKVISION-C
Dimensions	Ø4" × 3.2" (Ø100.4 mm × 82.4 mm)
Weight	Approximately 0.80 lb (362 g)

Dimensions



Accessories

NOT INCLUDED						
						
CPM Ceiling Pendant Mount	WMS Wall Mount Short	PC110 110 mm Pendant Cap	PM Pole Mount Adaptor	WM110 Plastic Wall Mount	AB110 Angled Base	CM Corner Mount Adapter