

SAFETY INFORMATION

Released Date: 2025-07-29

Please read and understand this entire manual before attempting to assemble, install or operate the product.

WARNING

- RISK OF ELECTRIC SHOCK - Before beginning installation, turn off electricity at the circuit breaker box or the main fuse box.

CAUTION

- For your safety, read instructions completely before beginning installation.
- If in doubt about electrical installation, consult a licensed electrician.

TOOLS REQUIRED

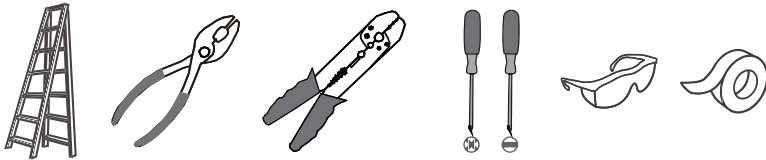

Ratings	120Vac, 60Hz	
	Model No.	Wattage
	PCWR8524C	33W
	PCWR8524MBK	33W
	PCWR8532C	48W
	PCWR8532MBK	48W

CARE AND MAINTENANCE

- Wipe clean using soft, dry cloth or static duster. Always avoid using harsh chemicals and abrasives to clean fixture as they may damage the finish.

If you need further assistance call Quozel Customer Care at 1-800-645-3184 (9:00am - 5:00pm EST), or visit us on-line at www.quezel.com.

PACKAGE CONTENTS

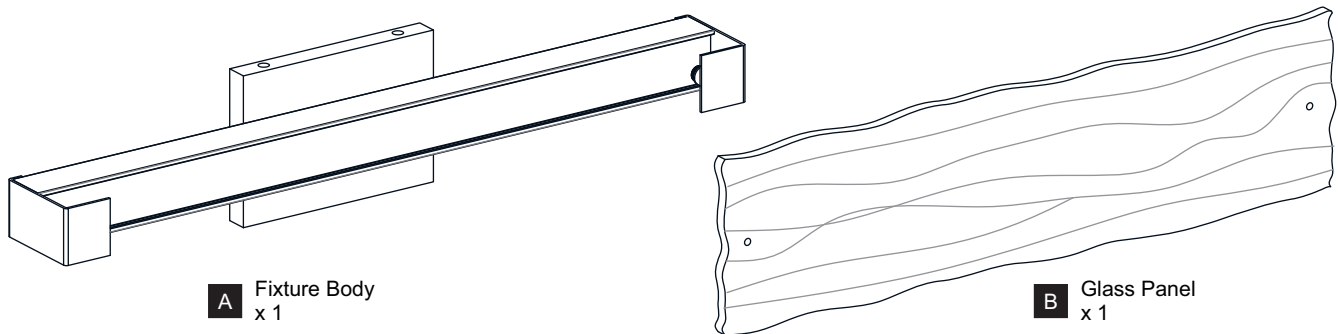

MOUNTING HARDWARE

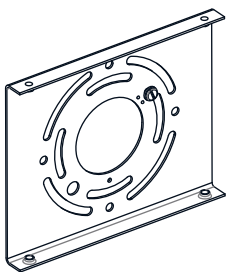

AA Inner Backplate
x 1



BB Mounting Screw
x 4

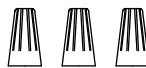

CC Wire Connector
x 3



DD Outlet Box Screw
x 2

INSTALLATION

1 Remove Glass Holders

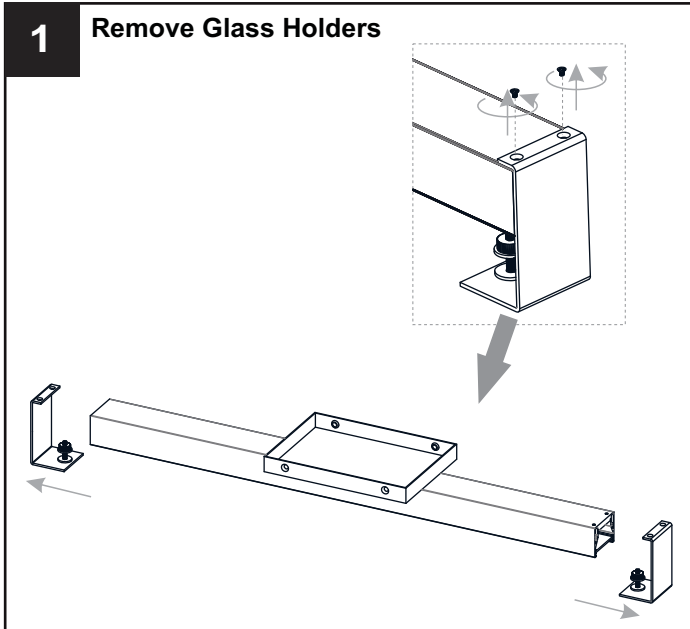

2 Install Glass Holders to Glass Panel

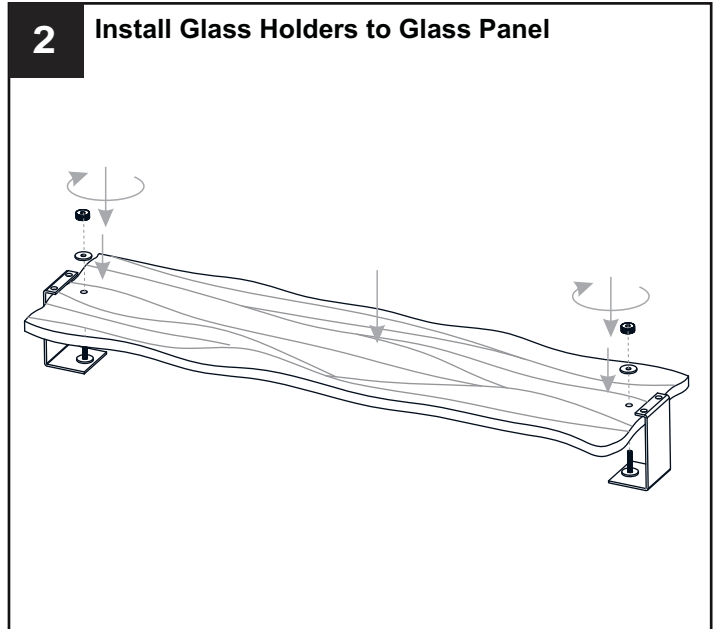

3 Install Glass Holders with Glass Panel to Fixture Body

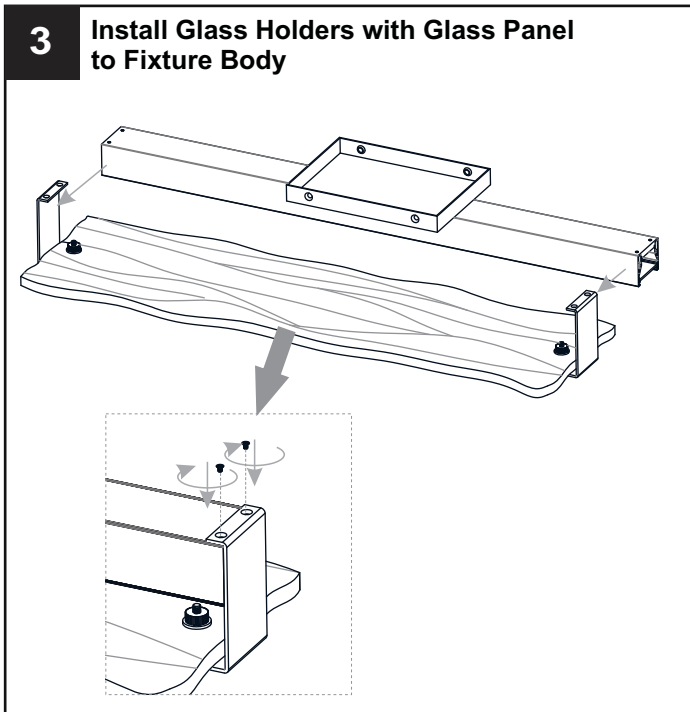

4 Install Inner Backplate

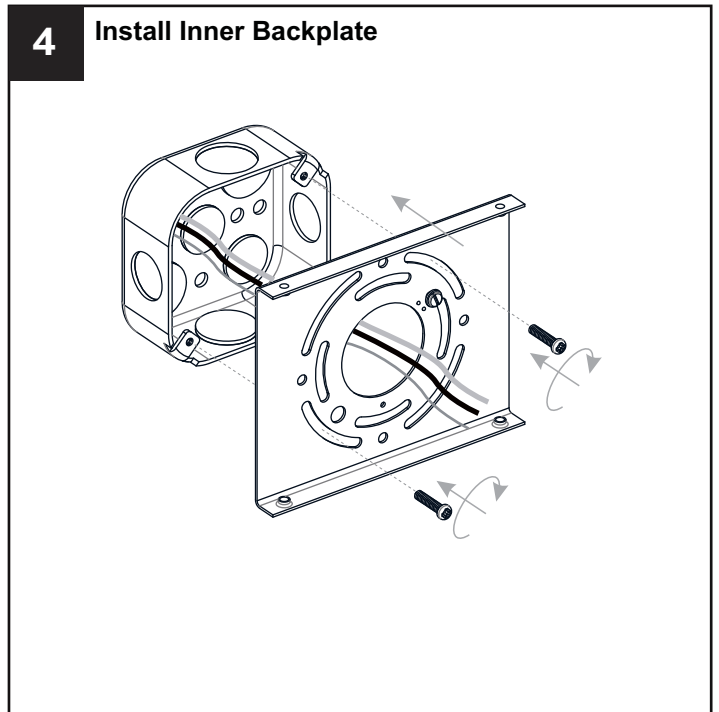

5 Wiring

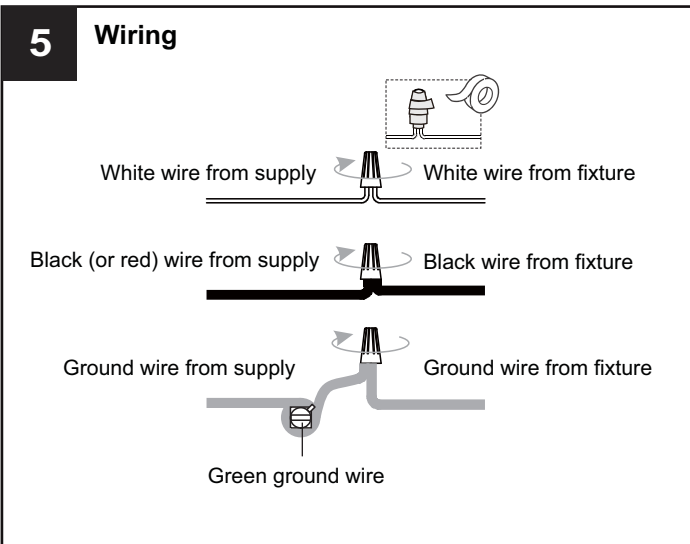

6 Install Fixture Body

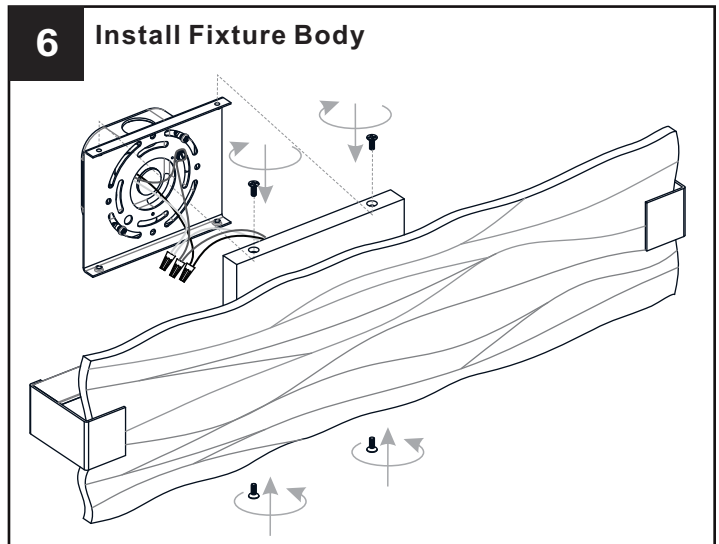

Your installation is now complete! Restore electricity and save this sheet for future reference.