







HEKMAN®

A HOWARD MILLER COMPANY

27664 ARTS & CRAFTS TABLE DESK

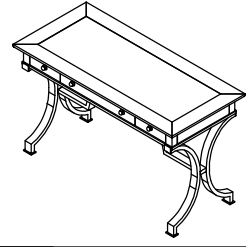
HARDWARE LIST				
A	B	C	D	E
ALLEN BOLT M6 x 20 (4 PCS.)	ALLEN BOLT M6 x 40 (4 PCS.)	FLAT W. M6 (8 PCS.)	SPRING W. M6 (8 PCS.)	ALLEN KEY L4 (FOR BOLT M4) 1 PC.
				

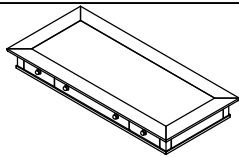

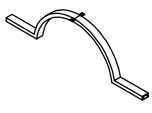
PART INSIDE		
1	2	3
TOP ASSEMBLY (1 Pc)	LEG ASSEMBLY (2 Pc)	STRETCHER (2 Pc)
		

Assembly Instruction

STEP 1.

ALIGN THE HOLES IN THE LEG ASSEMBLY (2) WITH THE STRETCHER (3). CONNECT USING FLAT WASHER (D), LOCK WASHER (C), ALLEN BOLT (A) AND ALLEN KEY (E) PROVIDED.

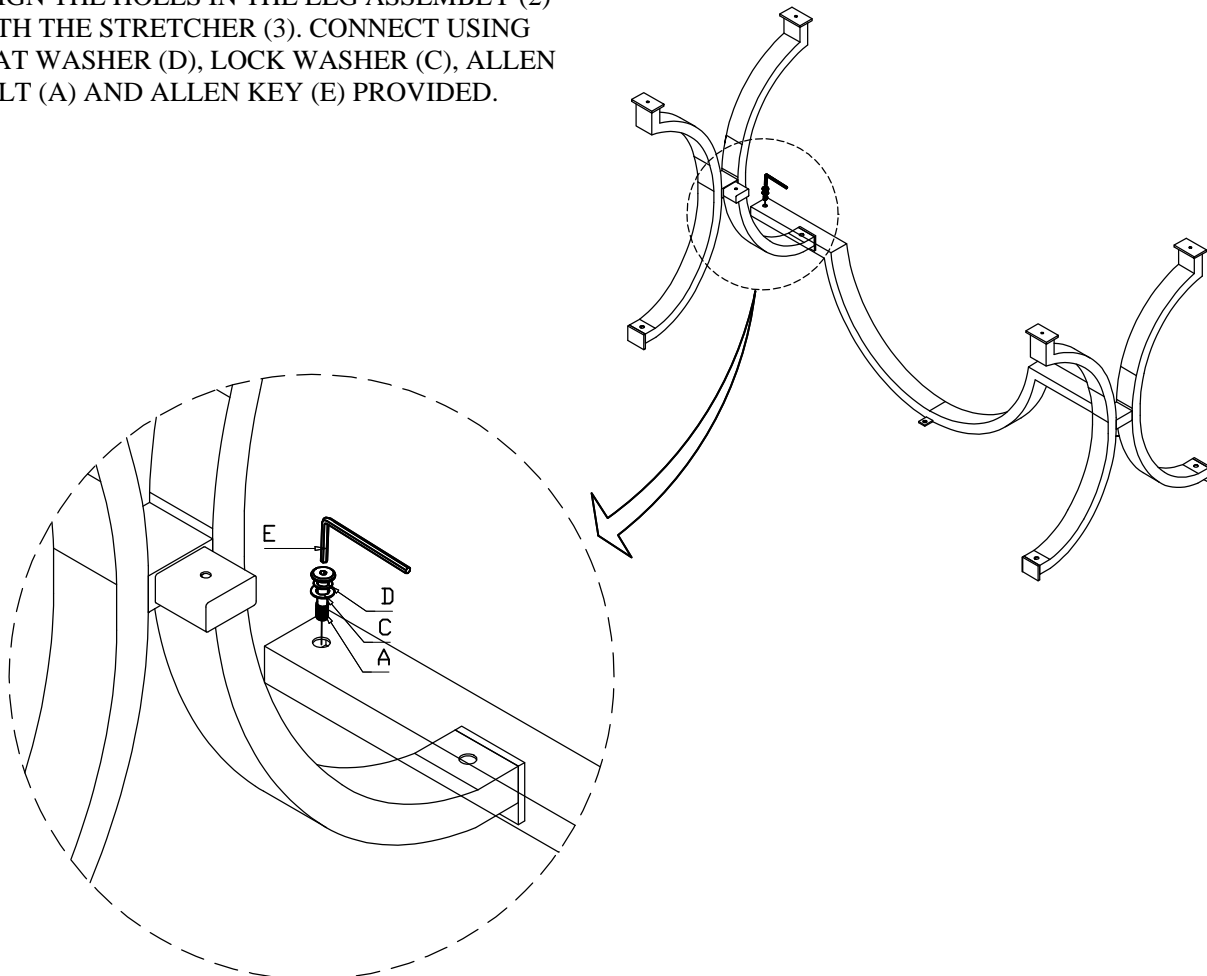

STEP 2.

LAY TOP PANEL UPSIDE DOWN ON A SOFT, CLEAN AND FLAT SURFACE. ALIGN THE HOLES IN THE LEG ASSEMBLY (2) WITH THE TOP ASSEMBLY (1). CONNECT USING FLAT WASHER (C), LOCK WASHER (D), ALLEN BOLT (B) AND ALLEN KEY (E) PROVIDED.

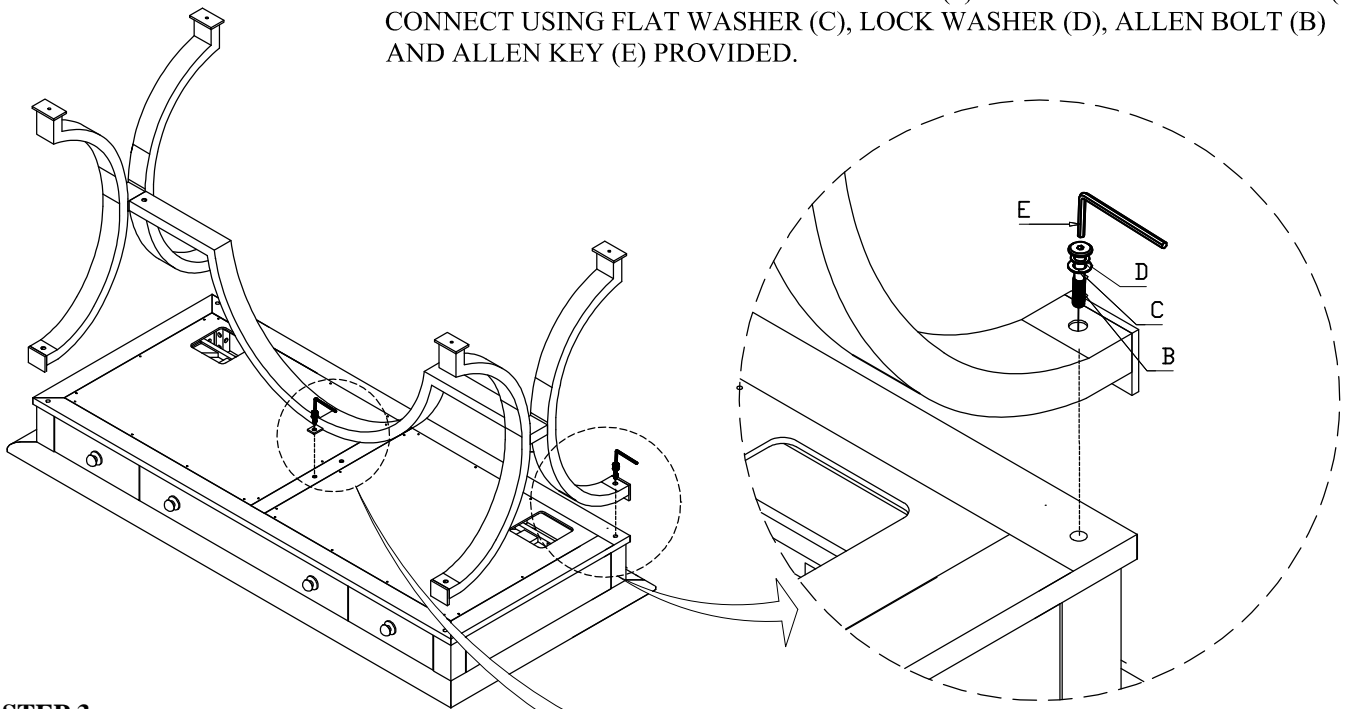

STEP 3.

ALIGN THE HOLES IN THE STRETCHER WITH THE INSERT TOP ASSEMBLY. CONNECT USING FLAT WASHER (D), LOCK WASHER (C), ALLEN BOLT (A) AND ALLEN KEY (E) PROVIDED.

