

### Features

- Two Lever handles offer separate control of hot and cold water
- 8-9/16" (217 mm) spout reach with slip-fit connection and diverter knob
- Coordinates with other products in the Tone collection
- Trim only, requires valve to complete installation

### Material

- Premium metal construction for durability and reliability
- KOHLER finishes resist corrosion and tarnishing

### Installation

- Deck- or bath-mount

### Required Products/Accessories

K-438-K 1/2" ceramic high-flow valve system

### Recommended Products/Accessories

K-21335-G Round two-function handshower, 1.75 gpm  
 K-27425 18" towel bar  
 K-27426 24" towel bar  
 K-27427 Robe hook  
 K-27428 Towel ring  
 K-27429 Pivoting toilet paper holder

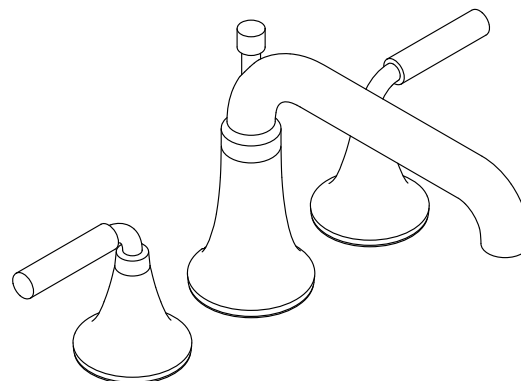

### Codes/Standards





ASME A112.18.1/CSA B125.1  
 ADA  
 ICC/ANSI A117.1  
 CSA B651  
 OBC

### KOHLER® Faucet Lifetime Limited Warranty

See website for detailed warranty information.

### Available Colors/Finishes

*Color tiles intended for reference only.*

Color	Code	Description
	CP	Polished Chrome
	BN	Vibrant® Brushed Nickel
	BL	Matte Black
	2MB	Vibrant® Brushed Moderne Brass
	BMB	Matte Black with Moderne Brass

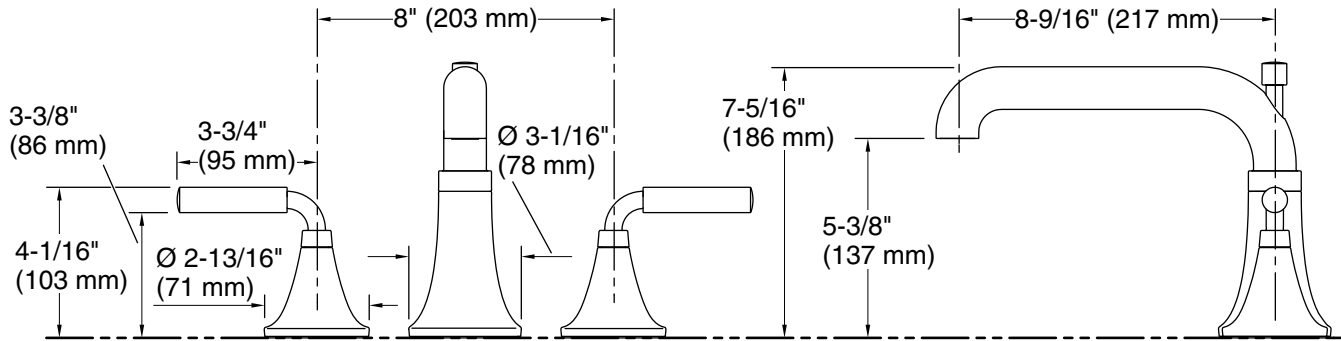

### Technical Information

All product dimensions are nominal.

#### Spout:

Spout reach: 8-9/16" (217 mm)

### Notes

Install this product according to the installation instructions.

ADA, OBC, CSA B651 compliant when installed to the specific requirements of these regulations.