

**Pool Breakdown**  
**Belize 30' Round 52"**  
**NB2529**

<b><u>FEATURES:</u></b> Round Size: 30q Depth: 52+ 15 Year Warranty	<b><u>STRUCTURE COMPOSITION:</u></b> Rugged Steel Frame Polymer Seat Caps Protective Wall Coatings
---	---

	Qty	Carton #	Carton Content Description
<input type="checkbox"/>	1	<b>3052-6H-WS-2</b>	BELIZE . 6 INCH TOP SEAT, 6 INCH VERTICAL, INSTRUCTIONS, PAPERWORK
<input type="checkbox"/>	1	<b>30-5/8RAIL-2</b>	BELIZE . 5/8 INCH RAIL
<input type="checkbox"/>	1	<b>30-6P-WS-3</b>	BELIZE . 6 INCH JOINT, 6 INCH SEAT COVER, 6 INCH SEAT COVER BRACKET, SEAT COVER ASSEMBLY BOLT PACKAGE
<input type="checkbox"/>	1	<b>3052-THT-W</b>	BELIZE . WALL (TERRA HAUTE TAUPE), PLASTIC EDGING, 52+WALL JOINT PACKAGE

# Carton Breakdown

## Belize 30' Round 52"

### NB2529

Key #	Qty	Item #	Mfg Part #	Part Description	
<b>FRAME CARTON # 3052-6H-WS-2</b>					
<input type="checkbox"/>	1	20	NBP1028	2366	6in Vertical (52+High)
<input type="checkbox"/>	6	20	NBP1023	1164	6in Top Seat L=1429mm (56-1/4") 15ft
<input type="checkbox"/>	---	1	-----	0022	Warranty
<input type="checkbox"/>	---	1	-----	0023	Safety Decals
<input type="checkbox"/>	---	1	-----	0024	Parts List + Frame Instruction
<input type="checkbox"/>	---	1	-----	0025	Safety Booklet
<input type="checkbox"/>	---	1	-----	0001	Round Instruction Manual
<b>FRAME CARTON # 30-5/8RAIL-2</b>					
<input type="checkbox"/>	4	40	NBP1108	1630	5/8in Rail L=1431mm (56-3/8")
<b>FRAME CARTON # 30-6P-WS-3</b>					
<input type="checkbox"/>	2	20	NBP1068	2168	6in Resin Joint - Upper
<input type="checkbox"/>	7	20	NBP1030	2464	6in Seat Cover Bracket
<input type="checkbox"/>	8	20	NBP1029	2463	6in Seat Cover
<input type="checkbox"/>	10	20	NBP1069	2268	6in Resin Joint - Lower
<b>Seat Cover Assembly Bolt Package (Part # 3318 / Order # NBP1032)</b>					
<input type="checkbox"/>	3	220	NBP1032	0341*	#12 Sheet Metal Screw
<input type="checkbox"/>	3	20	NBP1032	2402*	Resin Seat Cover Cap

\*These part #s are not available to purchase separately. They must be purchased as the Seat Cover Assembly Bolt Package, Order # NBP1032

**Carton Breakdown**  
**Belize 30' Round 52"**  
**NB2529**

Key #	Qty	Item #	Mfg Part #	Part Description	
<b>WALL CARTON # 3052-THT-W</b>					
<input type="checkbox"/>	5	22	NL107	8100	Plastic Edging
<input type="checkbox"/>	9	1	PC5247	52+Wall	Terra Haute Taupe Wall
<b>52" Wall Joint Bolt Package (Part # 0113, Order # NBP1021)</b>					
<input type="checkbox"/>	3	26	NBP1021	0513*	¼+x ½+Truss Head Screw
<input type="checkbox"/>	3	51	NBP1021	0411*	¼+Reinforcing Washer
<input type="checkbox"/>	3	26	NBP1021	0611*	¼+Nut

\*These part #s are not available to purchase separately. They must be purchased as the Wall Joint Bolt Package, Order # NBP1021

# Belize 30' Round 52"

NB2529

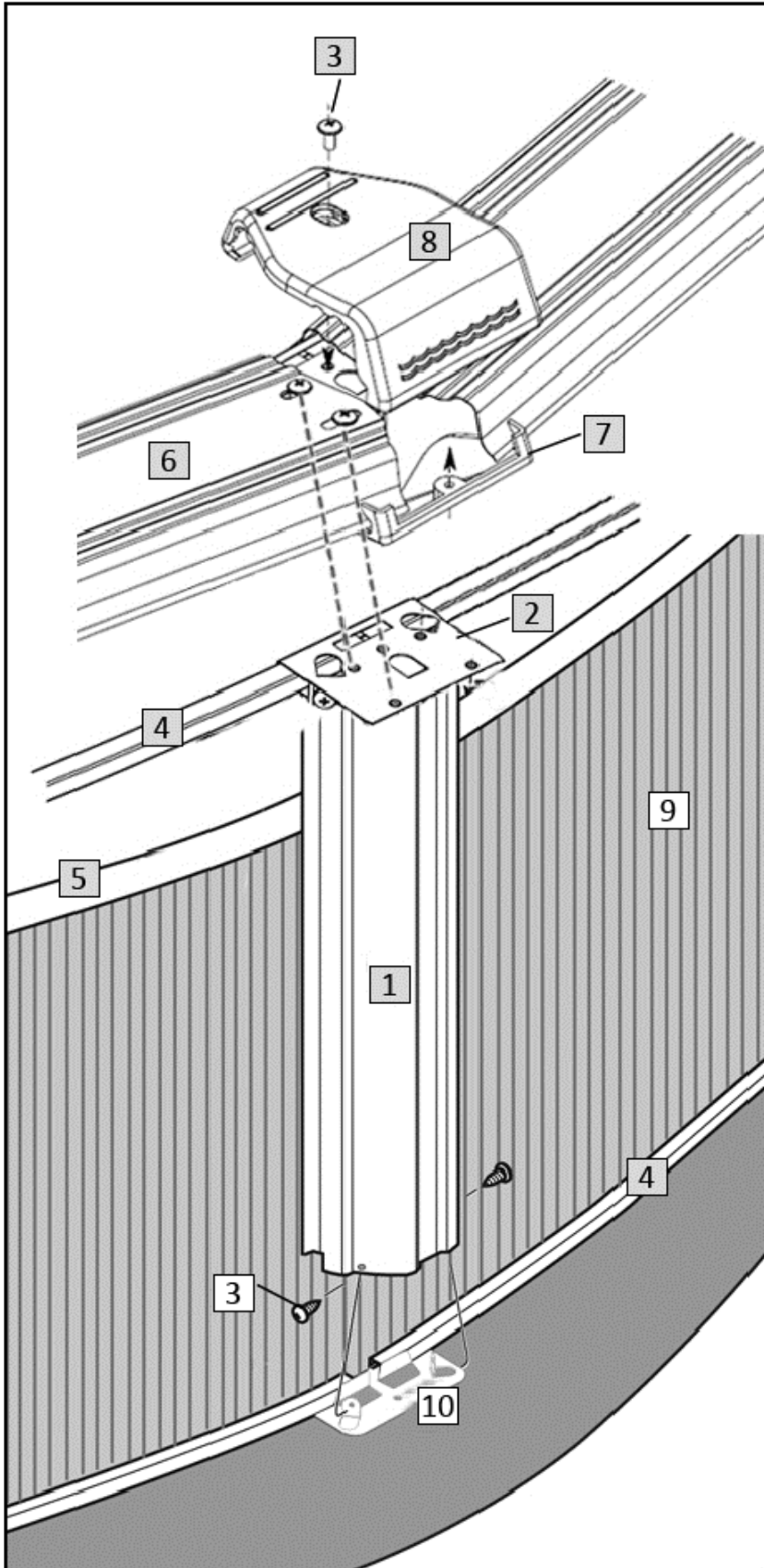

Key #	Part Description	Item #
1	6in Vertical	NBP1028
2	Resin Upper Joint	NBP1068
3	Seat Cover Hardware	NBP1032
3	Wall Joint Hardware	NBP1021
4	5/8+Rail	NBP1108
5	Plastic Edging	NL107
6	6in Top Seat	NBP1023
7	6in Seat Cover Bracket	NBP1030
8	6in Seat Cover	NBP1029
9	Wall	PC5247
10	Resin Lower Joint	NBP1069