

ASSEMBLY INSTRUCTION

OTTOMAN

A OTTOMAN

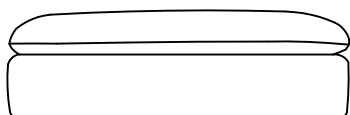

1pc

B LEGS

(Underneath the ottoman)



4pcs

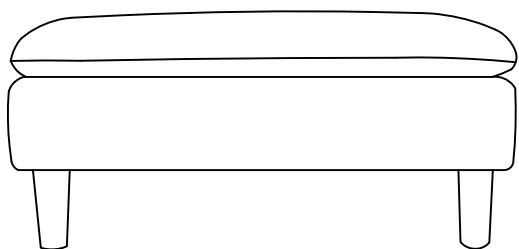

This page lists all the contents included in the box. As you unpack and prepare for assembly, place the contents on a carpeted or padded area to protect them from damage.

-
- 1** The legs(B) are stored at the bottom of ottoman(A), please take out them for assembly.

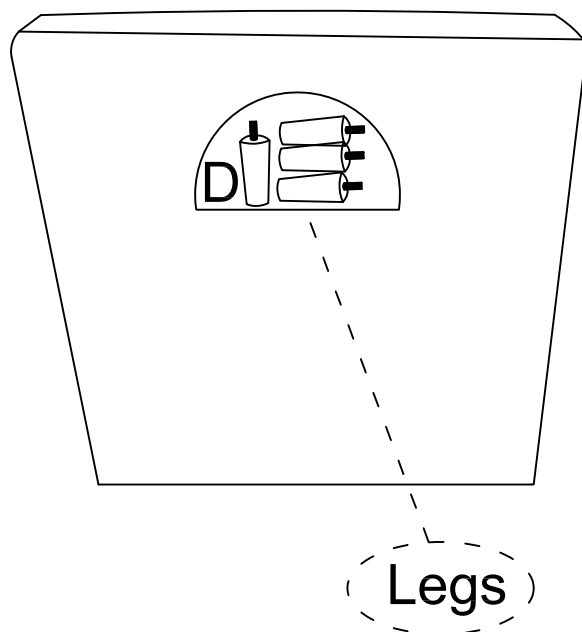

-
- 2** Insert the legs(B) to the pre drilled holes, rotate and tighten it . the assembly is completed .

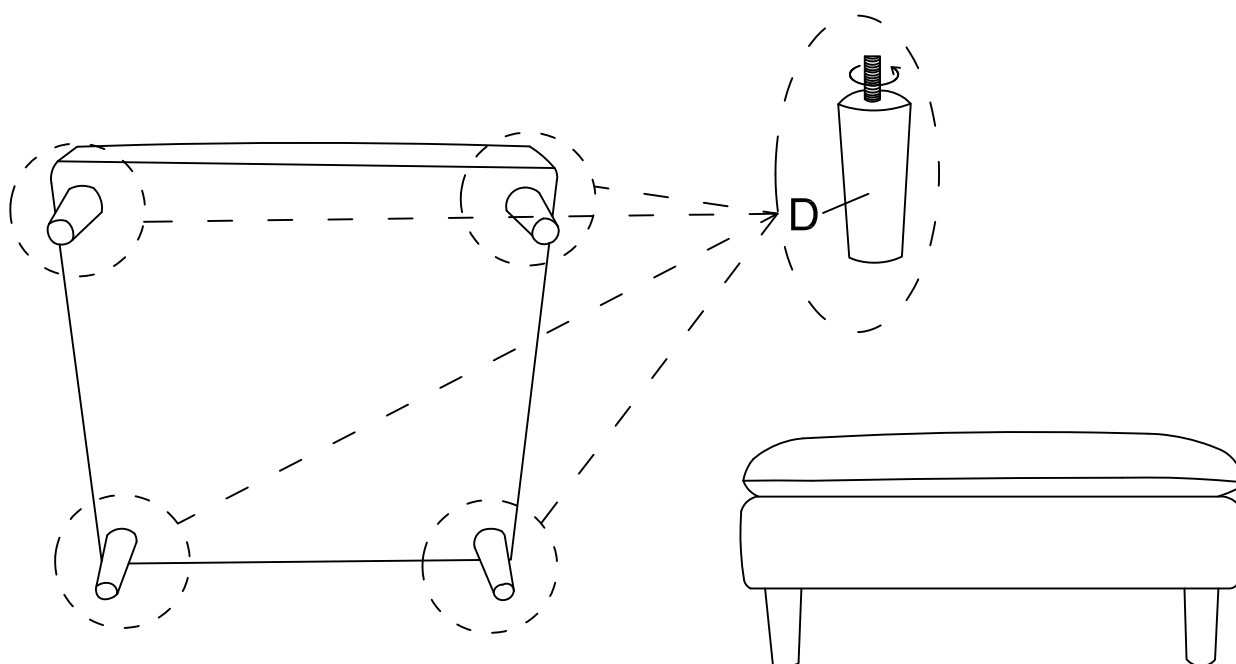

3

The ottoman can be hooked up with the armless chair together as below.

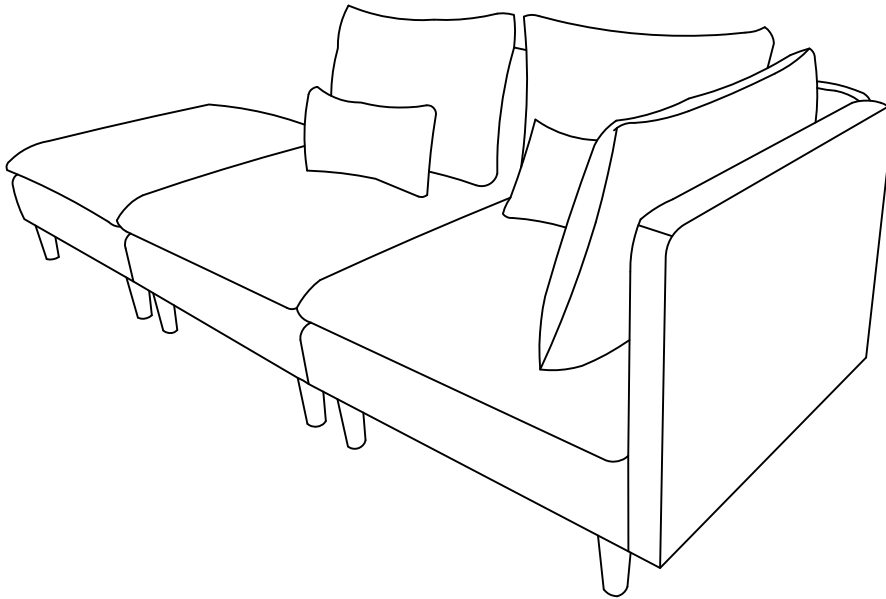

Cleaning & Care

Treat surface with care, Surface is resistant to scratches but is not scratch resistant, Clean surfaces with a dry or damp soft cloth. Do not use abrasive cleaners. Hardware may loosen over time. Periodically check that all connections are tight .

ASSEMBLY INSTRUCTION

CORNER

A CORNER SEAT

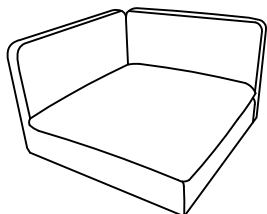

1pc

B BACK CUSHION

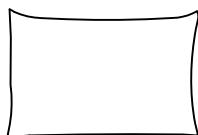

2pcs

C WAIST PILLOW



1pc

D LEGS

(Underneath the corner seat)



4pcs

E FLAT WASHER

(Underneath the corner seat)

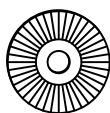

4pcs

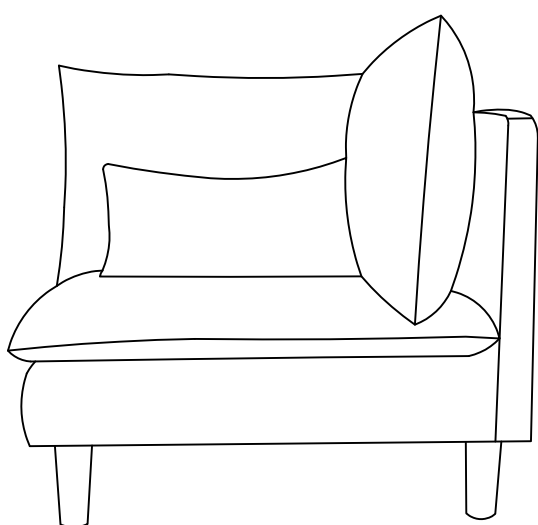

This page lists all the contents included in the box. As you unpack and prepare for assembly, place the contents on a carpeted or padded area to protect them from damage.

-
- 1** The legs(D) & flat washer(E) are stored at the bottom of corner seat(A), please take out them for assembly.

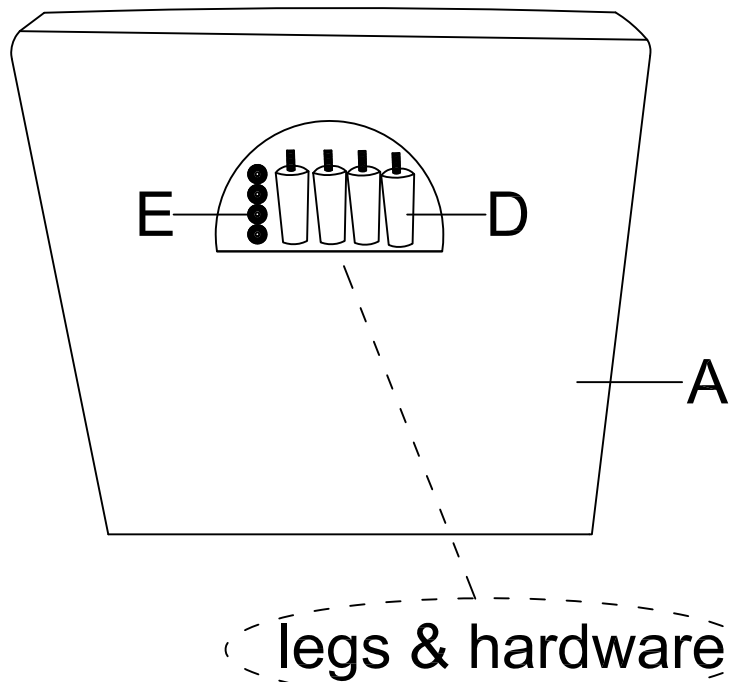

-
- 2** Insert the legs(D) & flat washer(E) to the pre-drilled holes, rotate and tighten it.

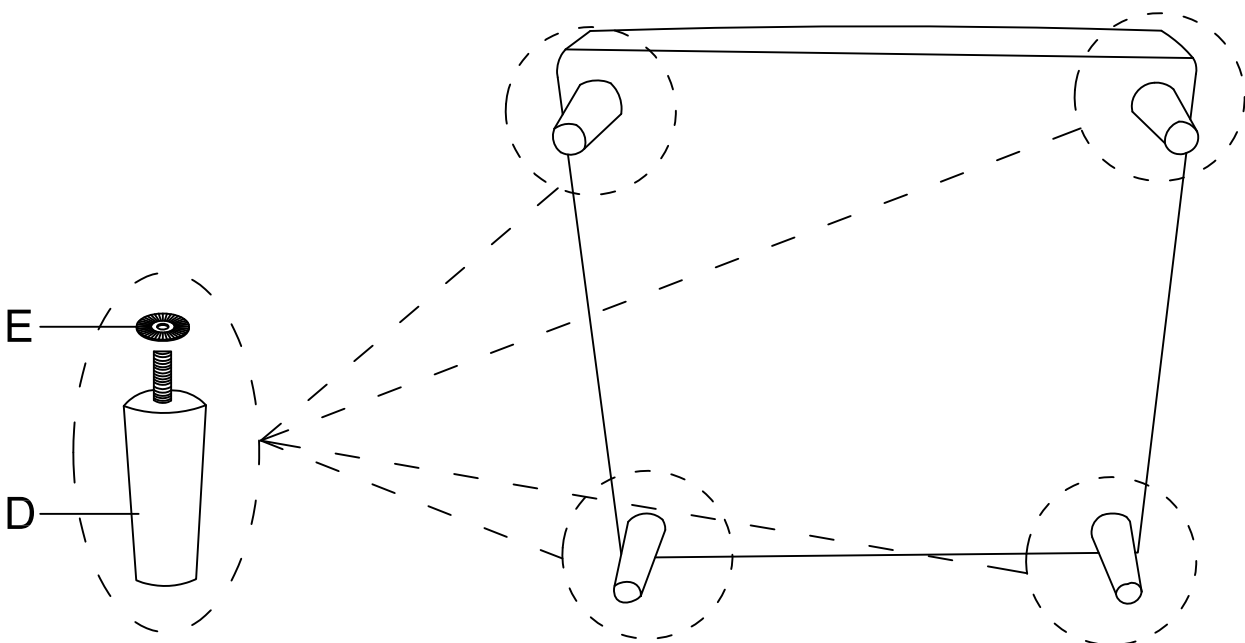

3 Put the back cushion(B) on corner seat(A).

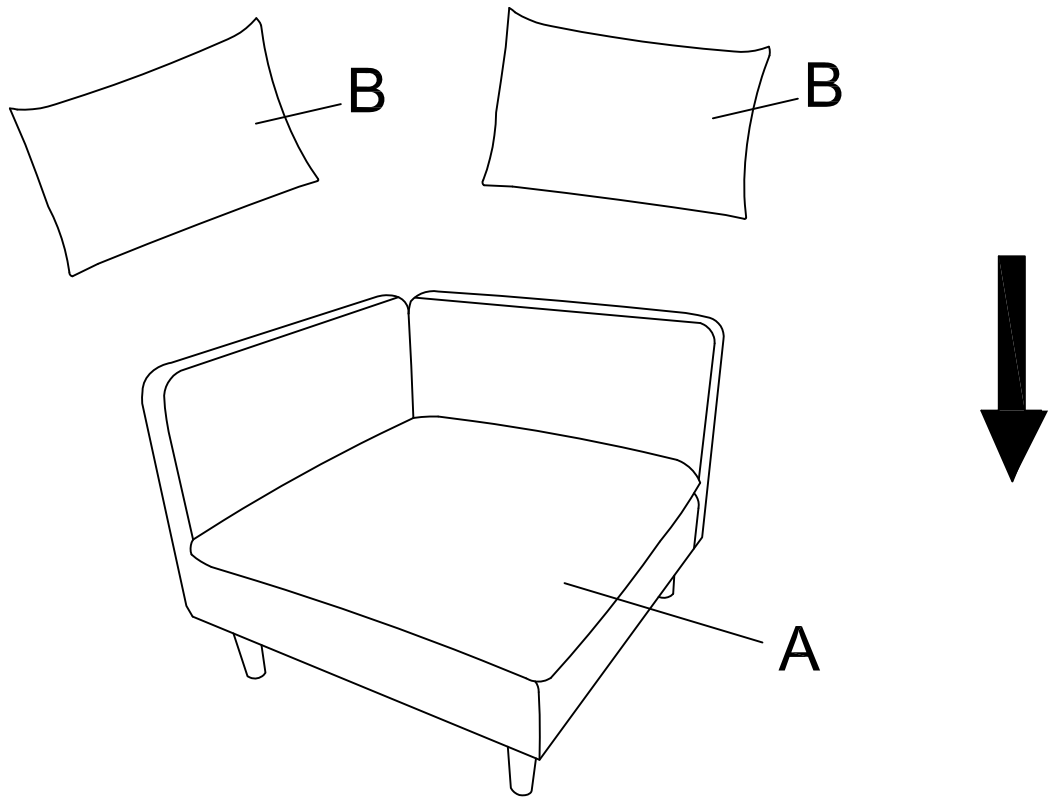

4 Put the waist pillow(C) on corner seat(A), the assembly is completed.

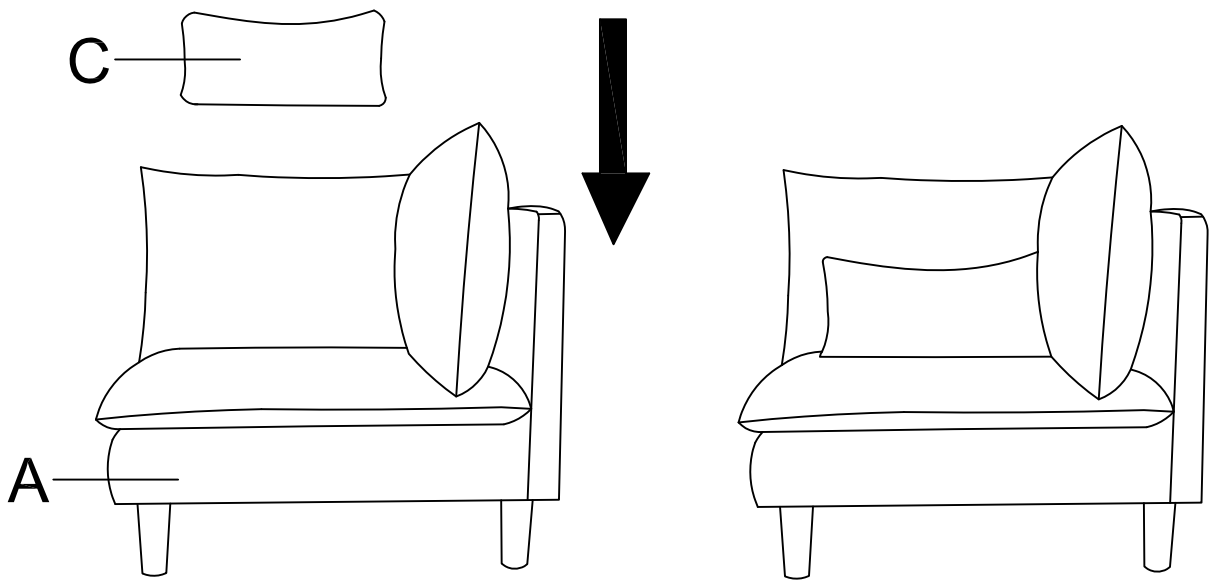

I-Shape:

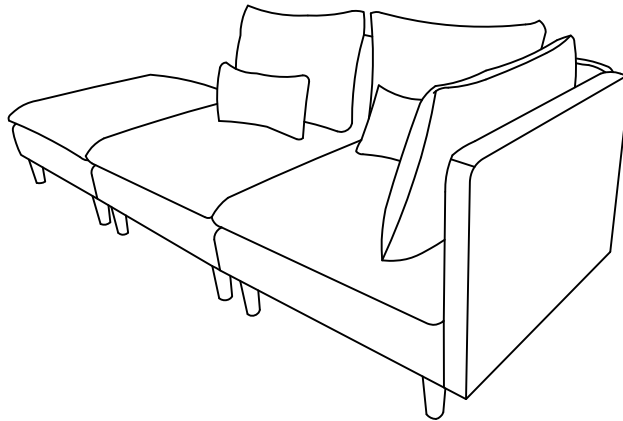

-
- 5** The corner can be hooked up with the armless chair together as below. The assembly is completed. (Armless chair & ottoman is not in the corner seat carton)

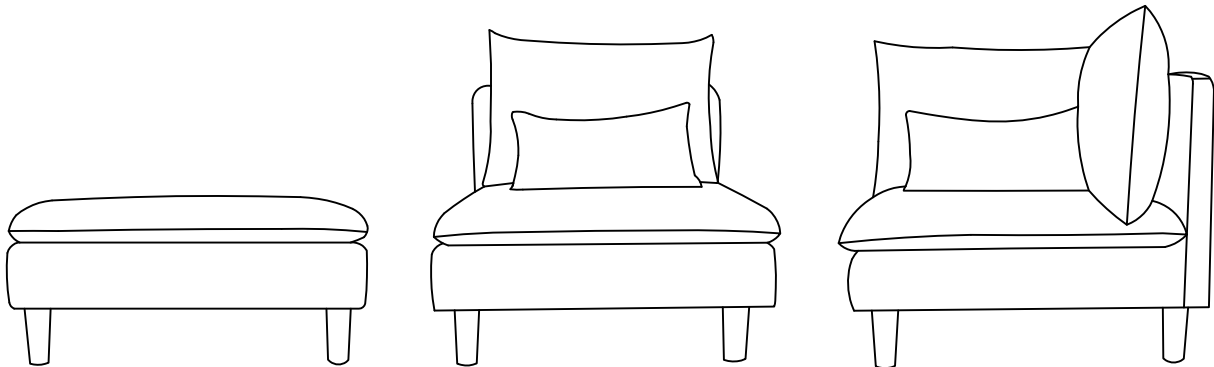

Cleaning & Care

Treat surface with care. Surface is resistant to scratches but is not scratch resistant. Clean surfaces with a dry or damp soft cloth. Do not use abrasive cleaners. Hardware may loosen over time. Periodically check that all connections are tight.

ASSEMBLY INSTRUCTION

ARMLESS CHAIR

A ARMLESS CHAIR

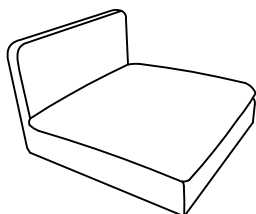

1pc

B BACK CUSHION

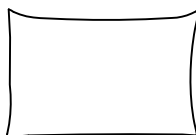

1pc

C WAIST PILLOW



1pc

D LEGS

(Underneath the armless chair)



4pcs

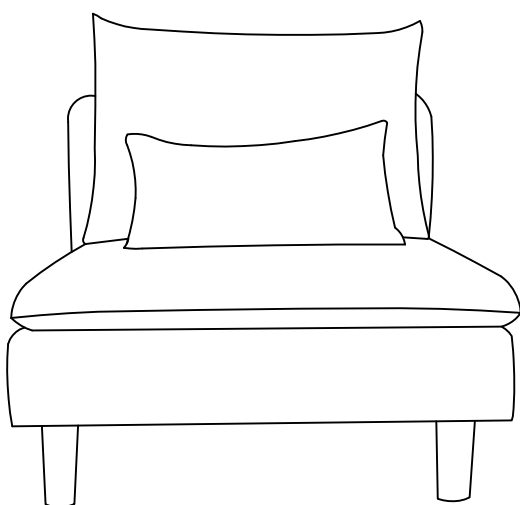

This page lists all the contents included in the box. As you unpack and prepare for assembly, place the contents on a carpeted or padded area to protect them from damage.

-
- 1** The legs(D) are stored at the bottom of armless chair(A), please take out them for assembly.

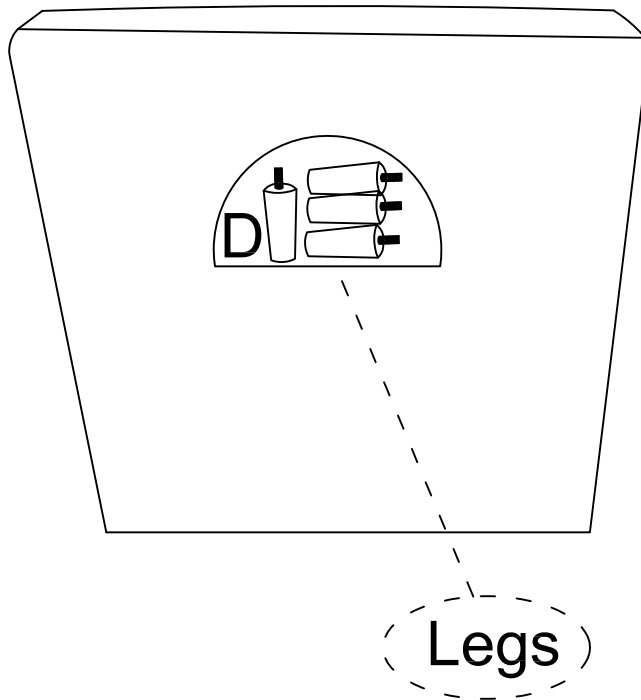

-
- 2** Insert the legs(D) to the pre drilled holes, rotate and tighten it .

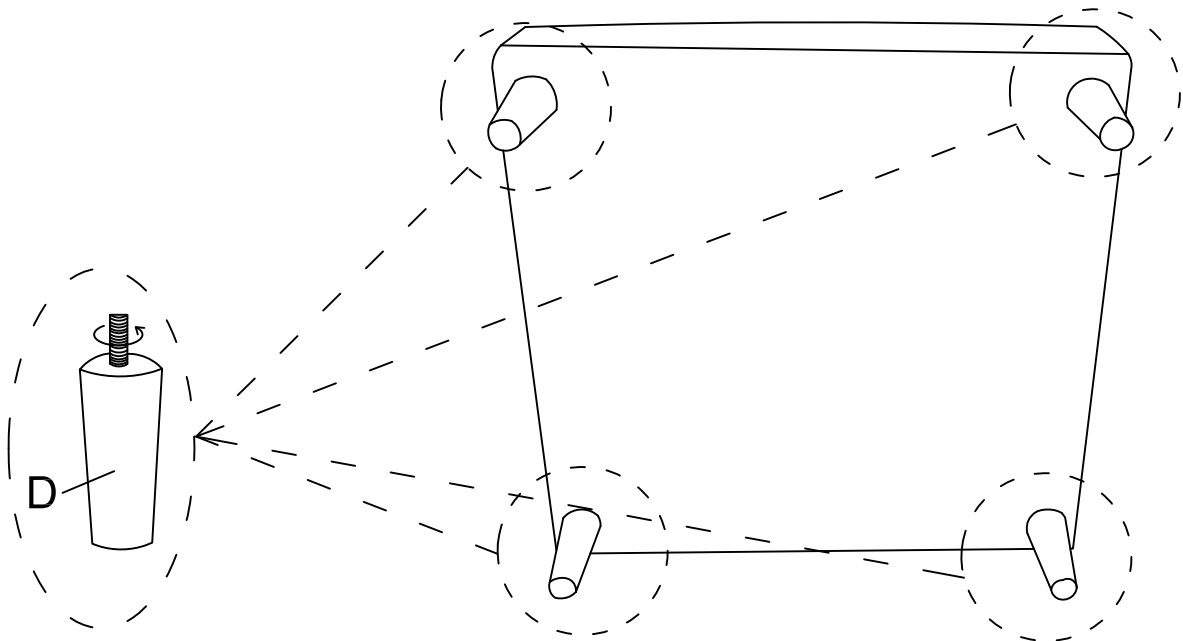

3 Put the Back Cushion(B) on Armless Chair(A).

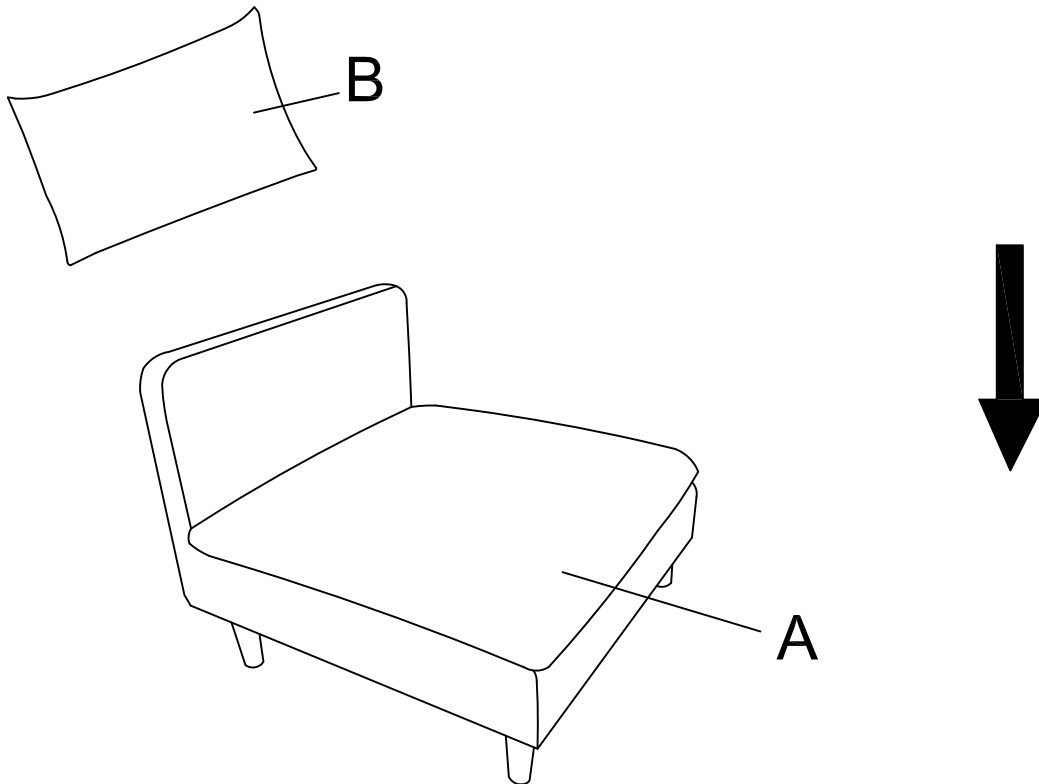

4 Put the Waist Pillow(C) on Armless Chair(A), the assembly is completed .

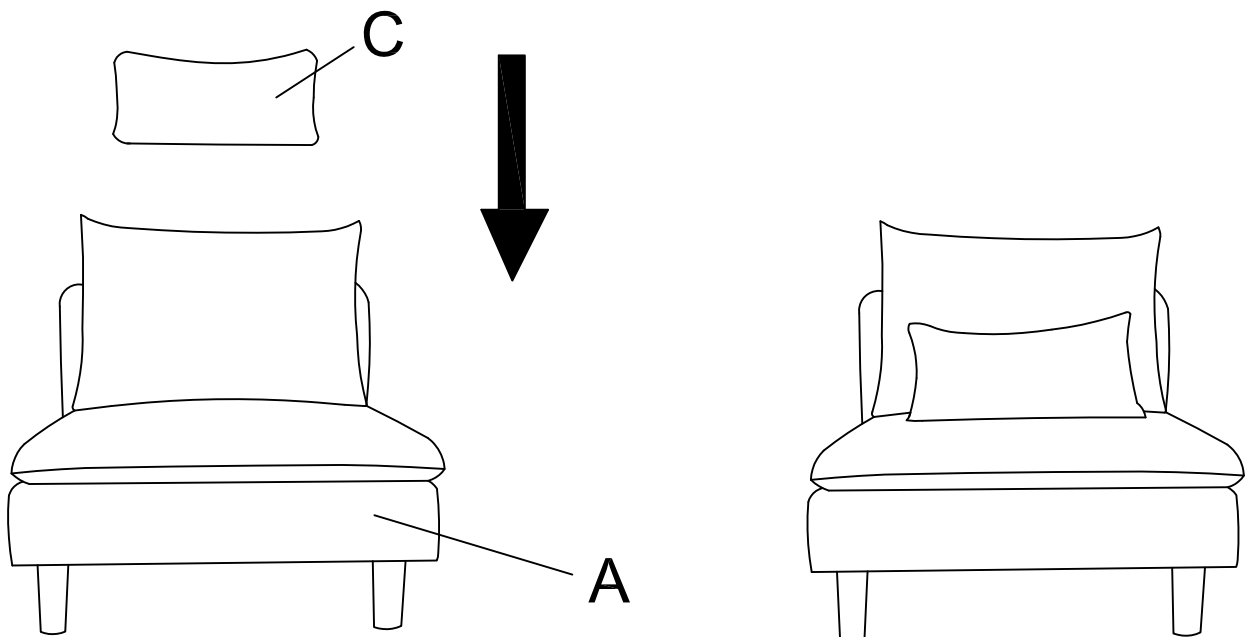

5

The armless chair can be hooked up with other set items together as below.

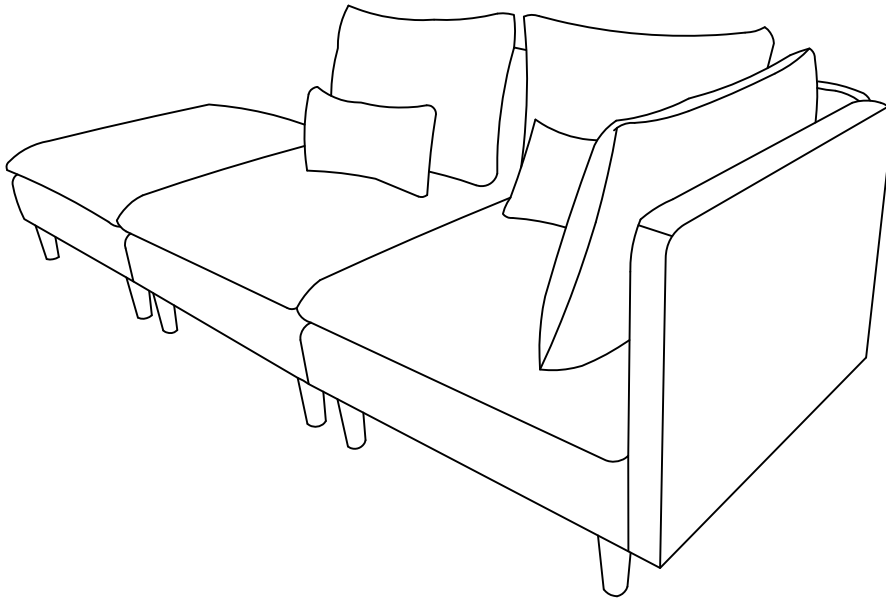

Cleaning & Care

Treat surface with care, Surface is resistant to scratches but is not scratch resistant, Clean surfaces with a dry or damp soft cloth. Do not use abrasive cleaners. Hardware may loosen over time. Periodically check that all connections are tight .