

# ASSEMBLY INSTRUCTION

## SOFA

**A** Sofa

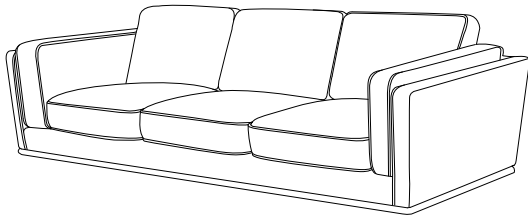

**B** Leg



1 pc

**C** Bolt  
25/64"\*2-23/64"

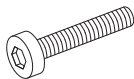

4 pcs

**D** Lock Washer  
25/64"

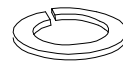

4 pcs

**E** Flat Washer  
25/64"

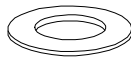

4 pcs

**F** Allen Wrench  
5/16"

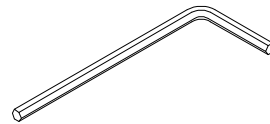

4 pcs

1 pc

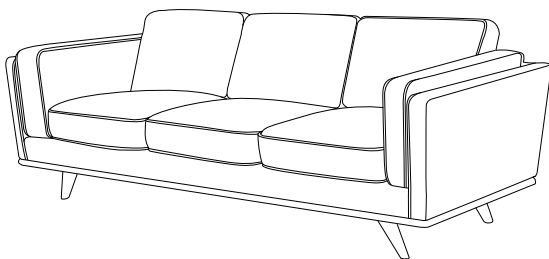

This page lists all the contents included in the box. Please take the time to identify the hardware as well as the individual components to this product. As you unpack and prepare for assembly, place the contents on a carpeted or padded area to protect them from damage.

**1**

Upside down the Sofa (A) on a carpeted or padded area. Take out 4pcs Leg (B) from the foot box.

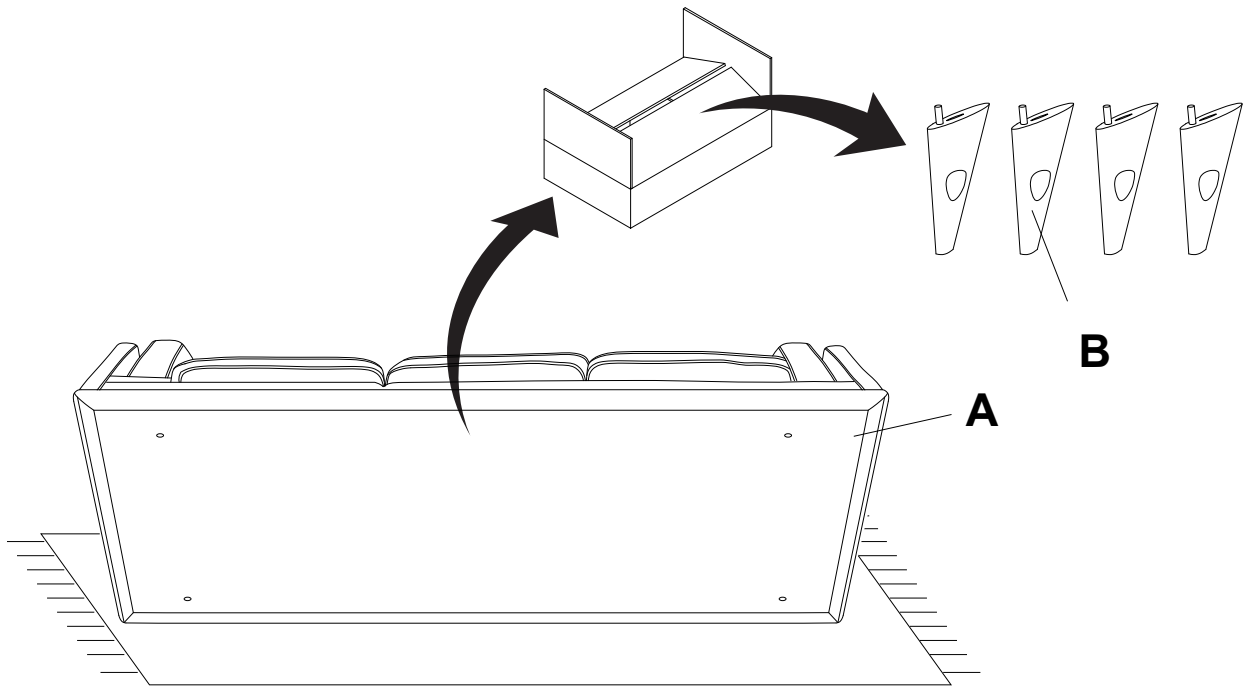
**2**

Tighten each Leg (B) by Bolt (C), Lock Washer (D) and Flat Washer (E) with Allen Wrench (F) in clockwise direction.

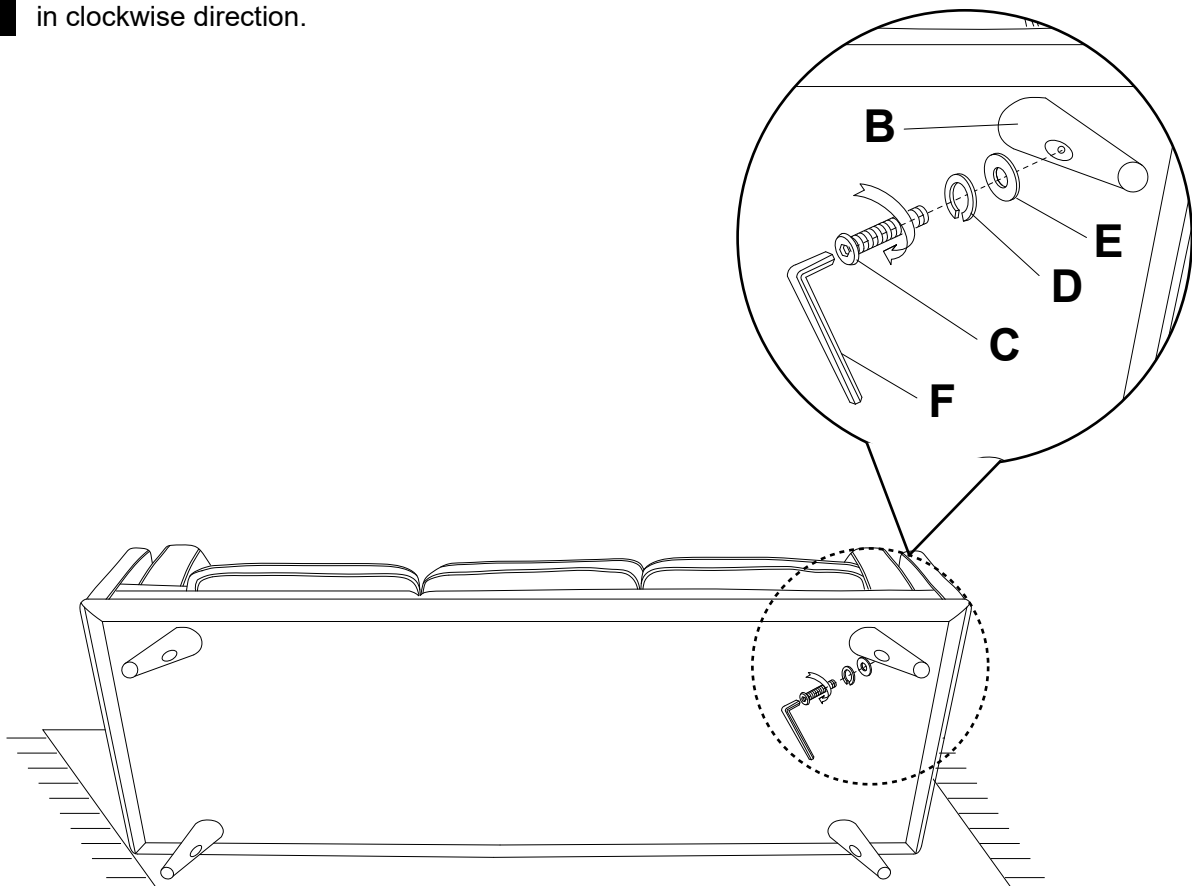

---

**3**

Two people are required to orientate the sofa on an even surface and check that it is balanced.

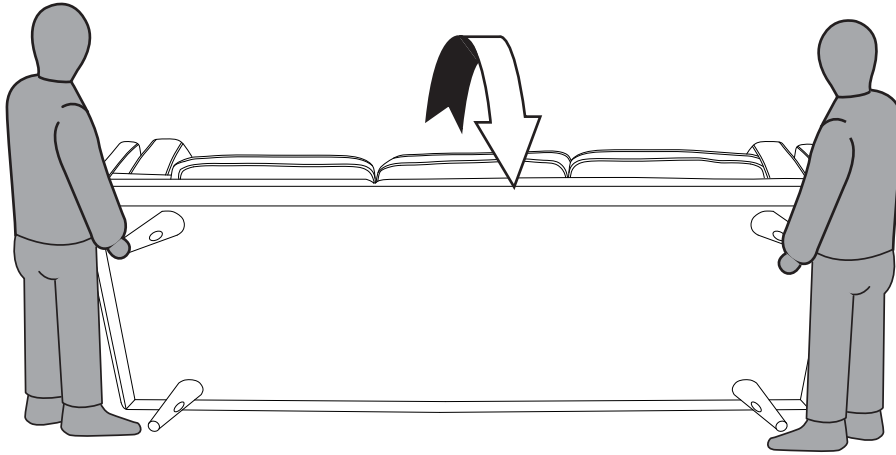

---

**Cleaning & Care**

Treat surface with care. Clean surfaces with a dry or damp soft cloth. Do not use abrasive cleaners. Hardware may loosen over time. Periodically check that all connections are tight.