

ASSEMBLY INSTRUCTION

E350BF/BQ/BK(NEW) HEADBOARD

A Headboard

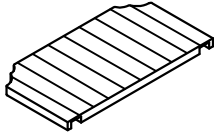

1pc

B Posts (Left & Right)

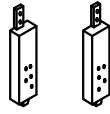

2pcs

C Bolt
M8x70mm



4pcs

D Lock Washer
M8x2mm



4pcs

E Flat Washer
M8x22mm



4pcs

F Allen Key
5mm

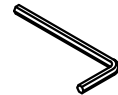

1pc

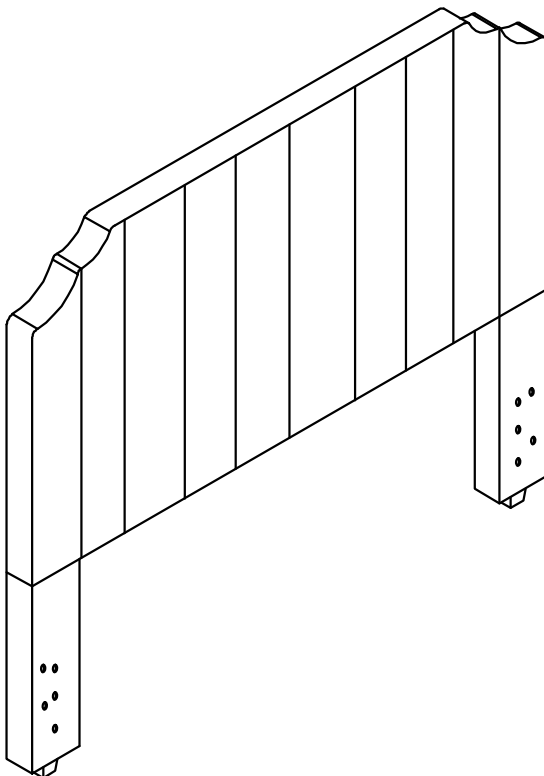

Please take the time to identify the hardware as well as the individual components this product. As you unpack and prepare for assembly, place the contents on a carpeted or padded area to protect them from damage.

Hardware package with white sticker is for customers using a bolt-on metal bed frame.

1 Take out the Posts (B) from back inside of Headboard (A).

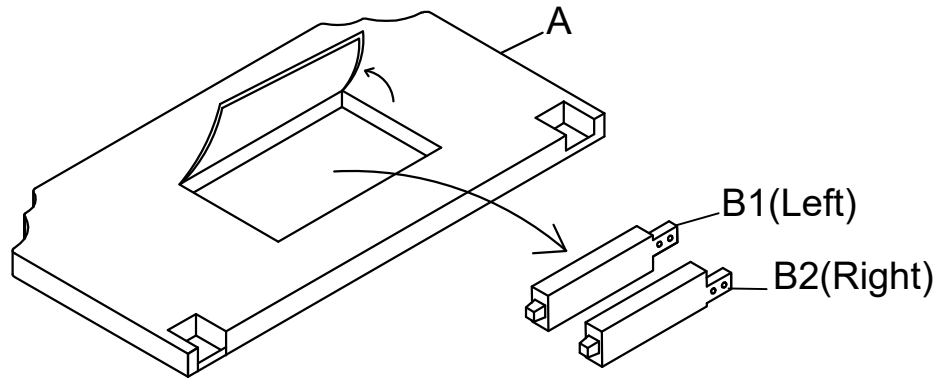

2 Attach Posts (B) to the Headboard (A) using Bolt (C), Lock Washer (D), Flat Washer (E) by Allen Key (F).

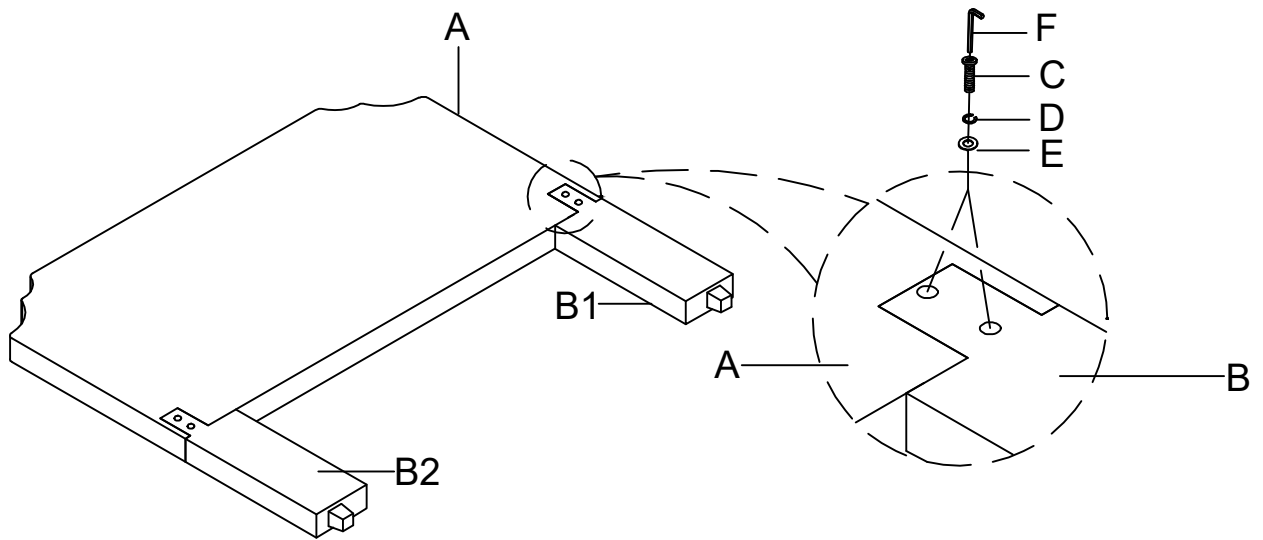



Cleaning & Care

Treat surface with care. Surface is resistant to scratches but is not scratch resistant. Clean surfaces with a dry or damp soft cloth. Do not use abrasive cleaners. Hardware may loosen over time. Periodically check that all connections are tight.

ASSEMBLY INSTRUCTION

1. This Assembly instruction is for customers using a bolt-on metal bed frame on headboard only.
2. Please refer to hardware package with white sticker when using this Assembly Instruction.
3. Full/Queen/King Headboard need to use the other Assembly Instruction in the carton to assemble the headboard first, then use this one.
4. Twin Headboard is fully assembled, customers only refer to this Assembly Instruction to assemble with your own mattress frame.

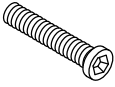
E350BF/BQ/BK HEADBOARD ONLY-SCREW

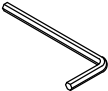
A Bolt M8x25mm	B Flat Washer M8x19mm	C Lock Washer M8x2mm	D Allen Key 5mm
			
6pcs	6pcs	6pcs	1pc

Assembly diagram below for attaching bolt-on metal bed frame to headboard only.

- 1** Attach mattress frame to the headboard using Bolt (A), Lock Washer (C), Flat Washer (B), then tighten by Allen Key (D).

