

## Features

- Dual-control wall-mounted
- Lever handles
- Stationary spout
- Less drain
- 6-1/4" (159 mm) 35° spout from wall to center of drain
- 1.2 gpm (4.5 lpm) maximum flow rate at 60 psi (4.14 bar)
- Valve sold separately

## Material

- Brass
- KOHLER finishes resist corrosion and tarnishing

## Required Products/Accessories

K-410-K Wall-mount Valve

## Recommended Products/Accessories

K-23726 Drain treatment  
K-14375 24" Double Towel Bar  
K-14377 Pivoting toilet paper holder  
K-14435 18" Towel Bar  
K-14436 24" Towel Bar  
K-14441 Towel Ring  
K-14443 Robe Hook  
K-14444 Vertical toilet paper holder



## Codes/Standards







ASME A112.18.1/CSA B125.1  
NSF/ANSI/CAN 61  
NSF/ANSI/CAN 372  
DOE - Energy Policy Act 1992  
EPA WaterSense®  
California Energy Commission (CEC)  
ADA  
ICC/ANSI A117.1  
CSA B651  
OBC  
NOM Standards  
NOM 012-CONAGUA

## KOHLER® Faucet Lifetime Limited Warranty

See website for detailed warranty information.

## Available Colors/Finishes

*Color tiles intended for reference only.*

Color	Code	Description
	CP	Polished Chrome
	SN	Vibrant® Polished Nickel
	AF	Vibrant® French Gold
	BN	Vibrant® Brushed Nickel
	BV	Vibrant® Brushed Bronze
	BL	Matte Black

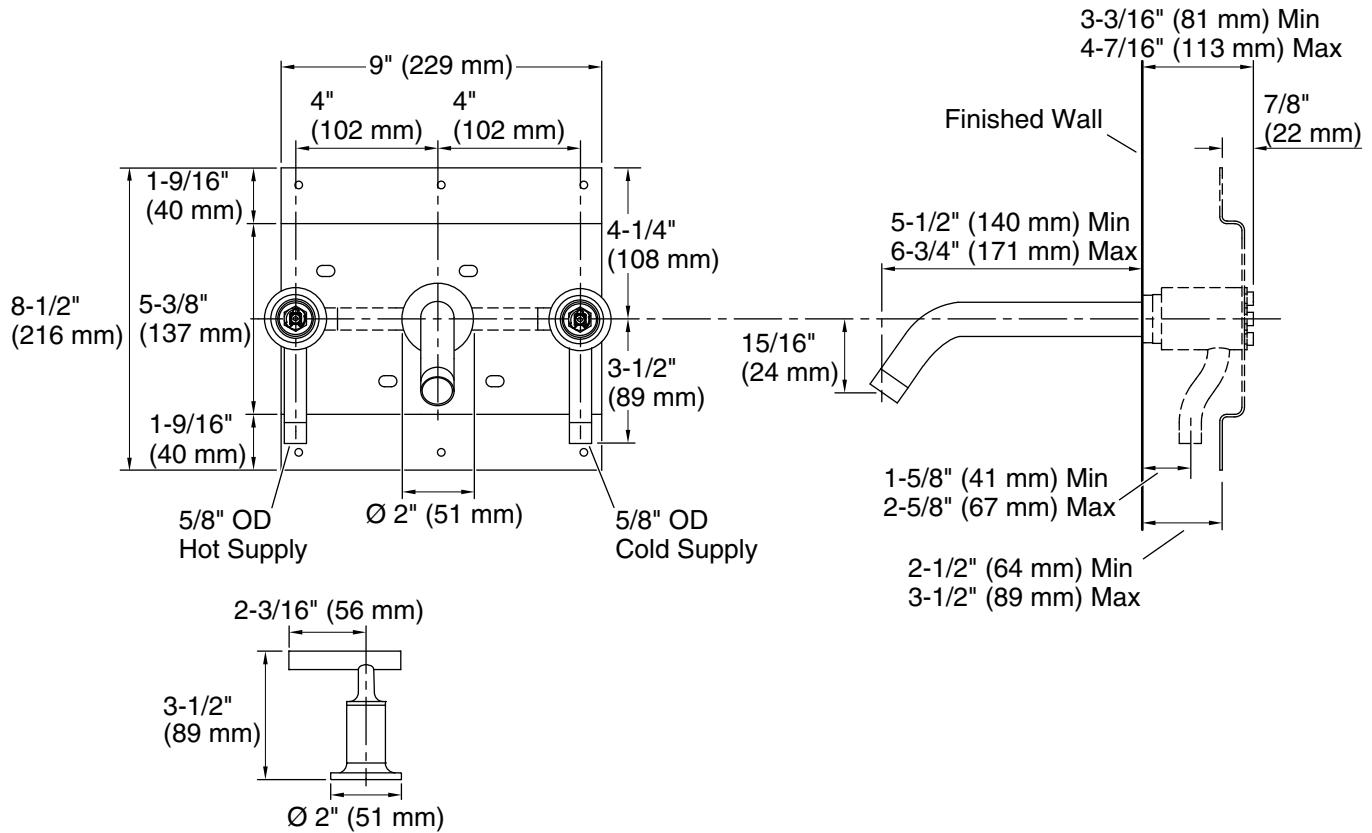

## Technical Information

All product dimensions are nominal.

Faucet flow rate: 1.2 gal/min (4.5 l/min)

### Spout:

Spout reach: 6-3/4" (171 mm)

## Notes

Install this product according to the installation guide.

The distance between the bottom of spout and top of the fixture rim must not be less than 1-1/2" (38 mm) and not greater than 6" (152 mm).

Three 1-1/2" (38 mm) diameter cutout holes are required for spout and handles.

ADA compliant for handles only.

ADA, OBC, CSA B651 compliant when installed to the specific requirements of these regulations.