

Features

- Cross handle
- Single handle controls temperature setting
- Part of the Occasion bathroom faucet and accessory collection

Material

- Premium material construction with metal handle ensures reliability and durability
- KOHLER finishes resist corrosion and tarnishing

Installation

- Patented K-joint installation technology ensures consistent trim appearance, regardless of variability in valve rough-in
- Wall-mount
- Trim only; requires valve to complete installation (sold separately)

Required Products/Accessories

K-2972-KS 1/2" thermostatic mixing valve



ADA

CSA B651

OBC

Codes/Standards









ASME A112.18.1/CSA B125.1
ADA
ICC/ANSI A117.1
CSA B651
OBC

KOHLER® Faucet Lifetime Limited Warranty

See website for detailed warranty information.

Available Colors/Finishes

Color tiles intended for reference only.

Color	Code	Description
	CP	Polished Chrome
	SN	Vibrant® Polished Nickel
	AF	Vibrant® French Gold
	BN	Vibrant® Brushed Nickel
	BV	Vibrant® Brushed Bronze
	BL	Matte Black
	2MB	Vibrant® Brushed Moderne Brass
	BMB	Matte Black with Moderne Brass

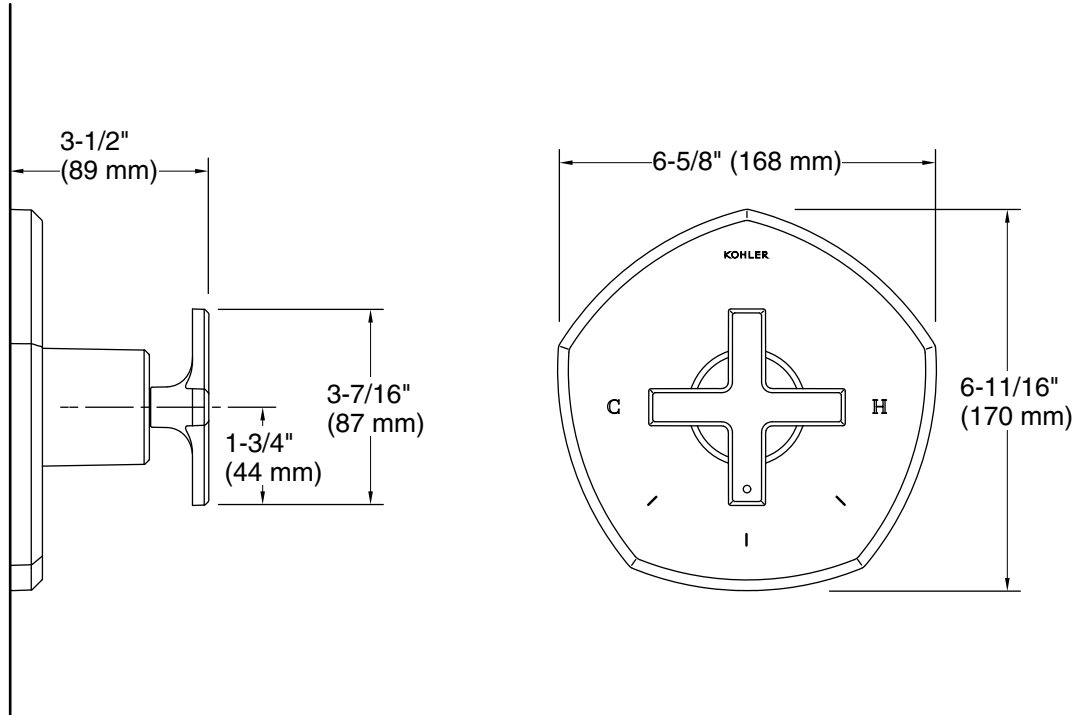

Technical Information

All product dimensions are nominal.

Spout:

Notes

ADA, OBC, CSA B651 compliant when installed to the specific requirements of these regulations.