

## Features

- Grip-Tight installation hardware makes it easy to fasten the seat – everything is done from above the bowl
- ReadyLatch® hinge provides a positive lock/unlock latch to securely hold seat in position, yet seat easily removes for cleaning or adjusting fit
- Quiet-Close™ round-front seat and lid prevent slamming
- Grip-Tight bumpers hold seat firmly in place
- Contoured seat for user comfort
- Color-matched plastic hinges
- Fits most round-front toilets

## Material

- Plastic construction

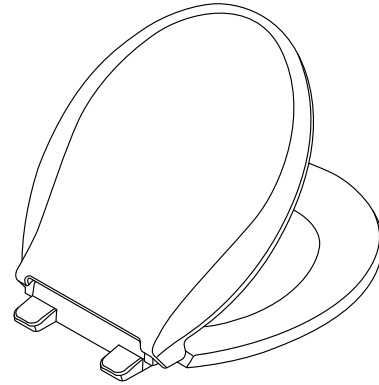

## Codes/Standards









IAPMO/ANSI Z124.5

## KOHLER® Toilets and Seats Limited Warranty

See website for detailed warranty information.

## Available Colors/Finishes

*Color tiles intended for reference only.*

| Color   | Code | Description   |
|---|------|---------------|
|  | 0    | White         |
|  | 96   | Biscuit       |
|  | 47   | Almond        |
|  | NY   | Dune          |
|  | 95   | Ice™ Grey     |
|  | G9   | Sandbar       |
|  | K4   | Cashmere      |
|  | 58   | Thunder™ Grey |
|  | 7    | Black Black™  |

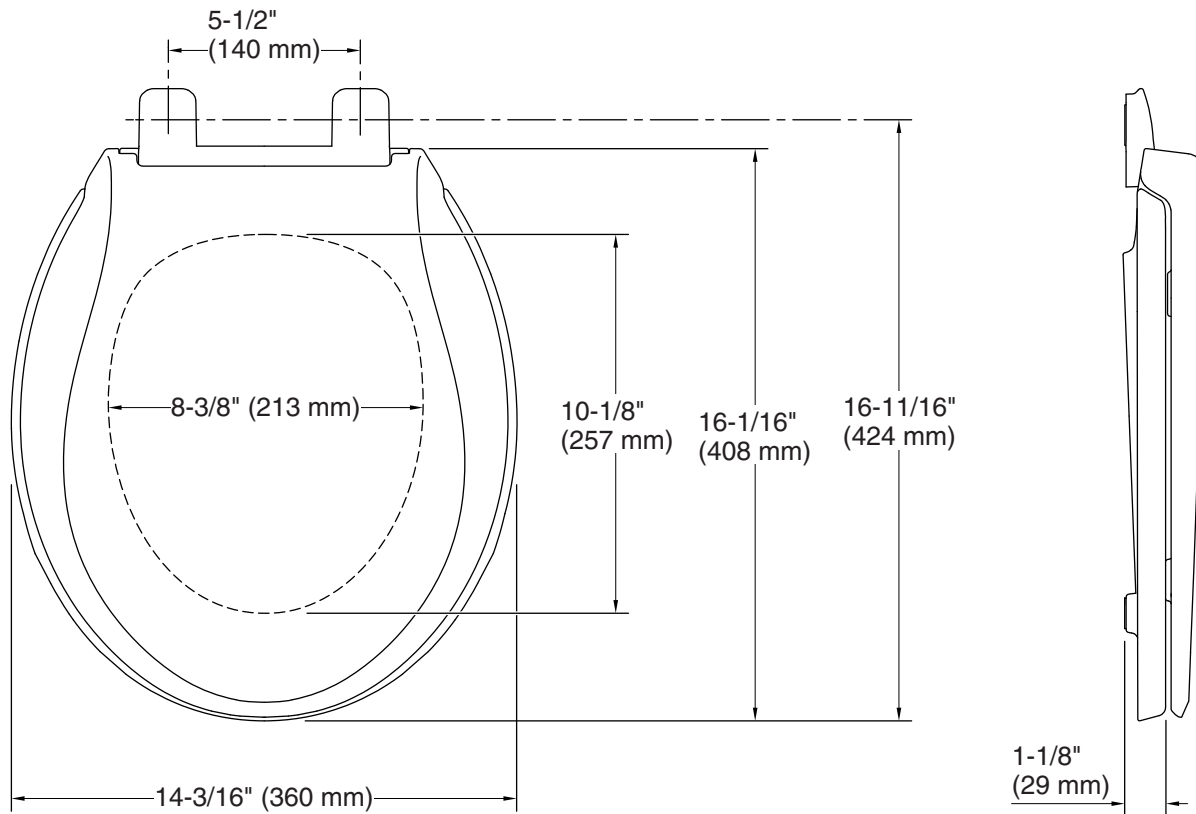

## Technical Information

All product dimensions are nominal.

Seat shape type: Round-front  
Seat front type: Closed-front  
Seat-mounting holes: 5-1/2" (140 mm)

## Pressure/fixture Supply Requirements