

# 48" 3CM 080 SERIES SOLID SURFACE COUNTERTOPS

**JAMES MARTIN**  
VANITIES

## Solid Surface

Our Arctic Fall solid surface is a manufactured product that combines natural minerals, resins and pigments, offering exceptional durability. It is highly dense and resistant to scratches, impact, and stains while maintaining its original beauty. Withstanding the rigors of daily use in busy households, it never compromises. Its non-porous nature prevents the penetration of liquids and bacteria, making it hygienic and easy to clean.

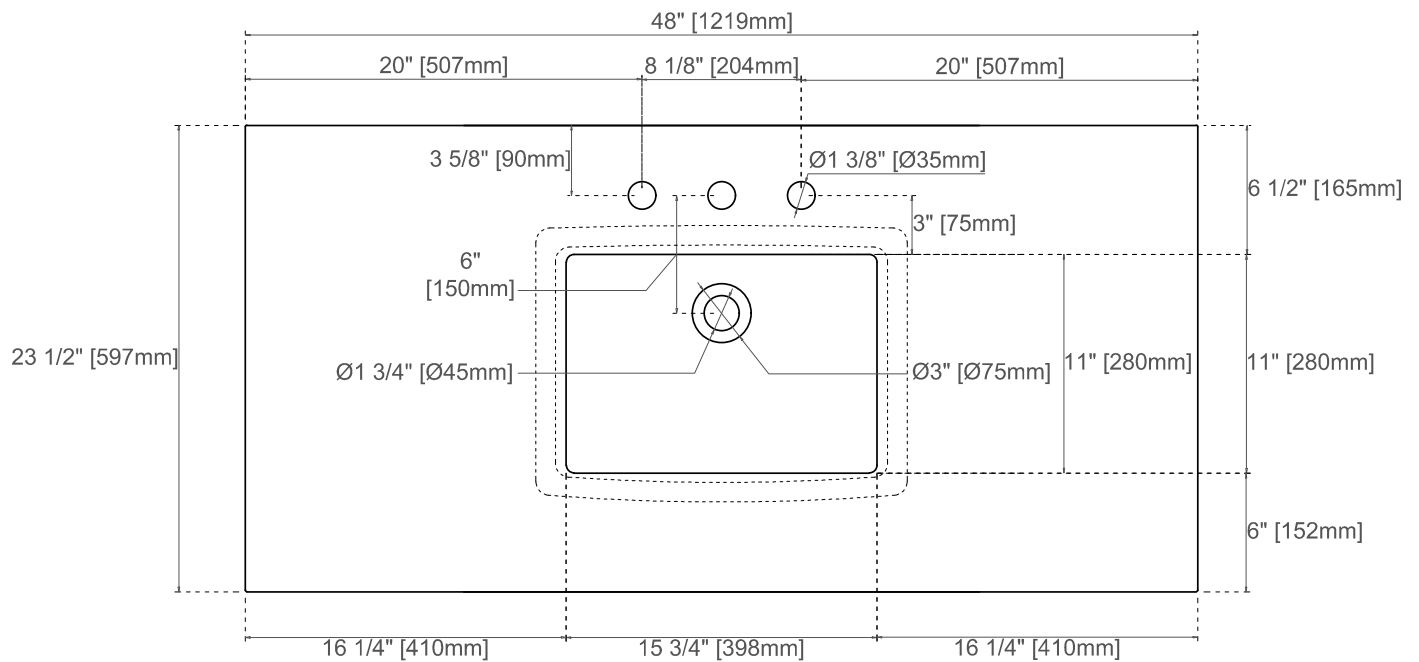

**All dimensions are nominal**

Visit website for warranty and installation information  
[www.jamesmartinvanities.com](http://www.jamesmartinvanities.com)

Version: 202301

---

## **Solid Surface Care and Maintenance**

**Routine Care:** Wipe the surface with soap and water on a regular basis to maintain its beauty. For deeper cleaning, use any Ph-balanced (less than 10) general-purpose household cleaner.

Using sealants and water repellents is unnecessary to maintain the original sheen of your solid surface top. Avoid using these products as they can create an undesirable build-up over time. If the surface of your Solid Surface countertop loses sheen, you may apply food-safe furniture spray.

**Light Stains:** Apply a small amount of a general-purpose household cleaner to the stain, let sit for 2 minutes and rub with a non-scratch scouring pad. Rinse immediately with water. For stains that harden as they dry, remove by gently scraping the surface with a razor blade or putty knife, holding it upright to avoid scratching the surface. Clean using warm, soapy water and rinse thoroughly.

**Difficult/Stubborn Stains:** Use a mild abrasive cleanser and clean the area with a non-scratch sponge. Rinse thoroughly. A 50/50 bleach water solution can also be used to clean tough stains.

**Hardwater Stains:** Apply a paste from equal parts baking soda and white vinegar. Let sit on the surface for 10-20 minutes and rub with a non-scratch pad. Rinse immediately with water.

## **General Precautions**

### **Avoid using the following:**

- Chlorine-based products
- Degreasing agents such as those used in oven cleaners
- Products high in alkaline (Ph over 10)

### **Heat Precautions**

The Arctic Fall solid surface is heat resistant to 360°F (182°C). However, avoiding sustained direct contact with heat sources such as curling irons and other heated appliances.

### **Sun Exposure**

- Solid surface materials are not intended for outdoor use
- Our Arctic Fall solid surface tops are resistant to UV damage. However, long-term exposure to UV light can affect the color of the surface.

### **Repairs**

Over time, scratches and small chips can happen, but they are easy to fix by sanding. Use a sanding sponge for small scratches and sandpaper for deeper scratches or small chips. Start with 100 or 150-grit coarse sandpaper and finish with fine sandpaper and a sanding sponge to restore the smooth finish of your solid surface products.

# SNK-RS RECTANGULAR PORCELAIN UNDERMOUNT SINK

**JAMES MARTIN**  
VANITIES

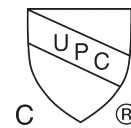
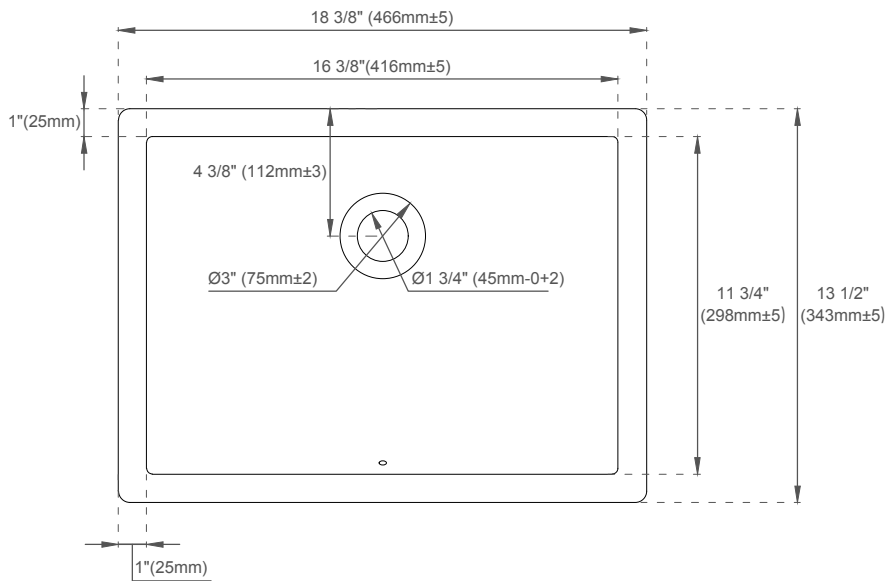

**ASME A112.19.2/CSA B45.1**

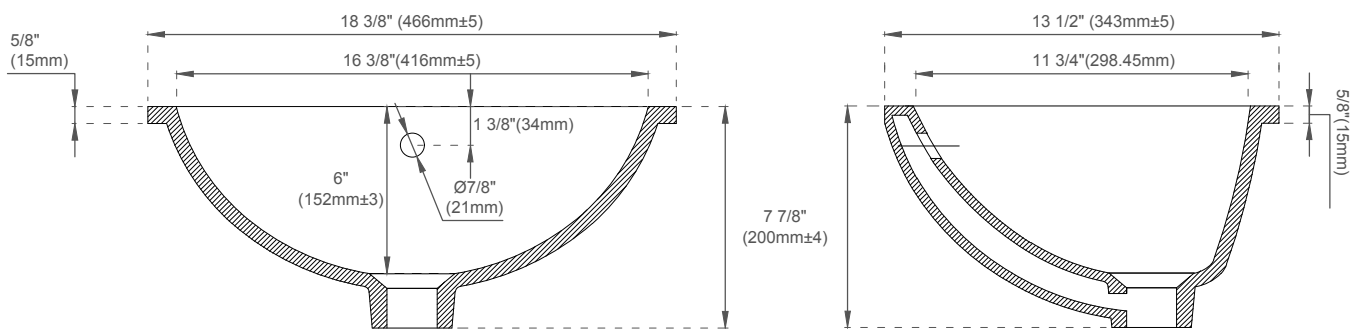

## FEATURES:

- Designed to fit with all James Martin Vanities with a 3cm Carrara (090 series) and Solid Surface (080 series) tops
- Sink Material: Porcelain
- Integrated overflow
- Sink shape: Rectangular with straight sides
- Sink(s) ship in a separate carton from the top and vanity
- Sink clips and hardware are not included. All mounting hardware ships with the 3cm quartz tops
- Drain included: NO
- Faucet included: NO
- Overflow cover: NO

## EXTERNAL DIMENSIONS:

Length: 18-3/8"  
Width: 13-1/2"  
Height: 7-7/8"

## INTERNAL BASIN DIMENSIONS:

Basin Length: 16-3/8"  
Basin Width: 11-3/4"  
Basin Depth: 6"  
Fits Drain Hole Size: 1-1/2"

**All dimensions are nominal**

Visit website for warranty and installation information  
[www.jamesmartinvanities.com](http://www.jamesmartinvanities.com)

Version: 202301