

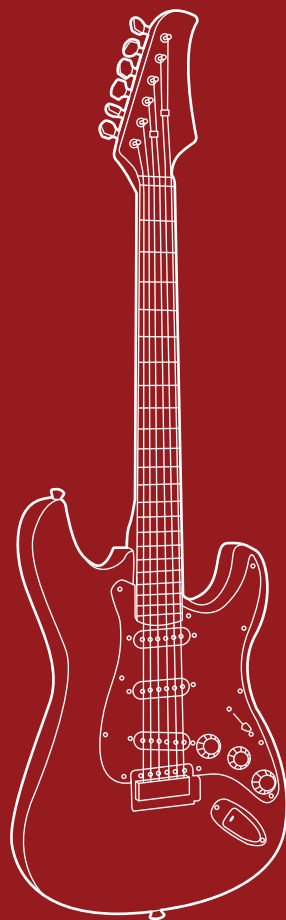

BEST CHOICE  
PRODUCTS



# INSTRUCTION MANUAL

---

## Electric Guitar

SKY1032 + SKY1033 + SKY5654 + SKY5923 + SKY5924 + SKY5925  
SKY5926 + SKY5927 + SKY7106 + SKY7107 + SKY7108 + SKY7109  
SKY7110 + SKY7111



**BEST CHOICE  
PRODUCTS**

---

As shoppers, we're always trying to find the perfect balance between quality & value. At BCP, we believe we've achieved that. Our diverse catalog of everyday essentials is tailored especially to our customers & guaranteed to hit that sweet spot of high quality & low price.

— Always. —

## ! NOTICE

Please retain these instructions for future reference.

- This product is intended for residential use only.
- Repairs to amplifier or electrical components of guitar should be done by a professional.
- If replacing the fuse or conducting any repairs, unplug amplifier from electricity or electric mains before replacing the fuse or conducting repairs.
- The fixed bolt should not be over 4 mm (Diameter) x 30 mm (Length) to prevent the fixed bolt from touching the switch and fuse holder.

## ⚠ WARNING

- To avoid risk of electrical shock, do not expose to water or humidity.
- Always connect instrument cord to guitar before connecting cord to amplifier to avoid damage to speaker.
- Do not leave guitar unattended with volume level turned up.
- Neon or fluorescent lighting near the amplifier may cause a hum from amplifier.
- To avoid damaging your ears, turn down volume of amplifier before plugging in headphones or speakers.
- Plugging in a pair of headphones will turn off your amplifier speaker.

## PARTS

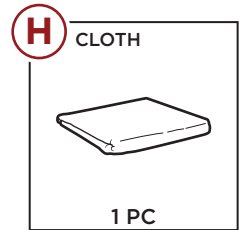
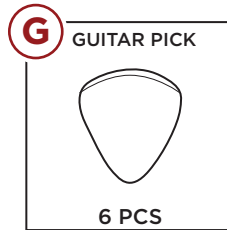
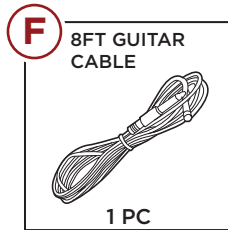
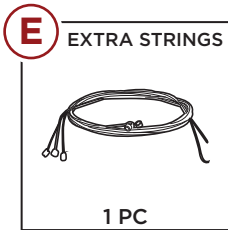
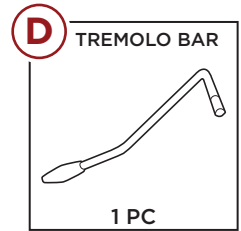
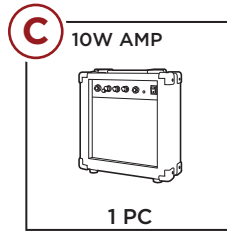
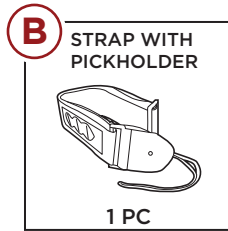
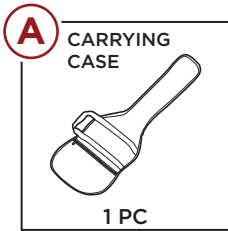

## GUITAR ANATOMY

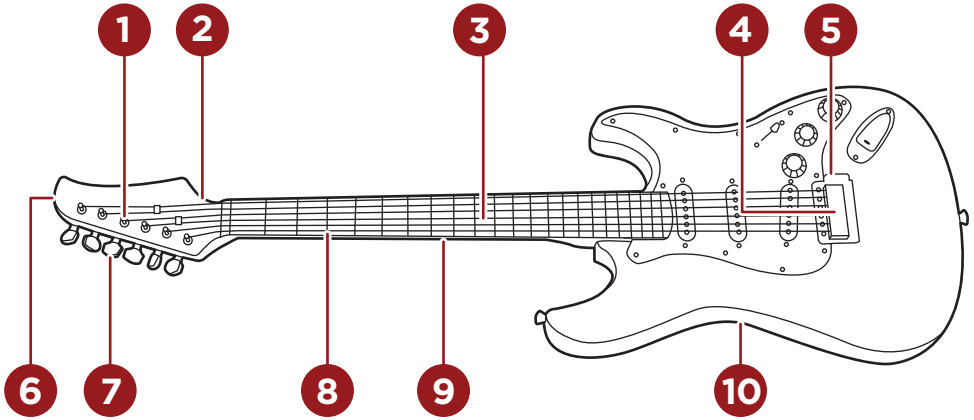

- |                                |                   |          |
|--------------------------------|-------------------|----------|
| 1. Tuning Machine              | 4. Saddle         | 8. Fret  |
| 2. Truss Rod (behind the head) | 5. Bridge         | 9. Neck  |
| 3. String                      | 6. Headstock/Head | 10. Body |
|                                | 7. Tuning Machine |          |

## 10-WATT AMP

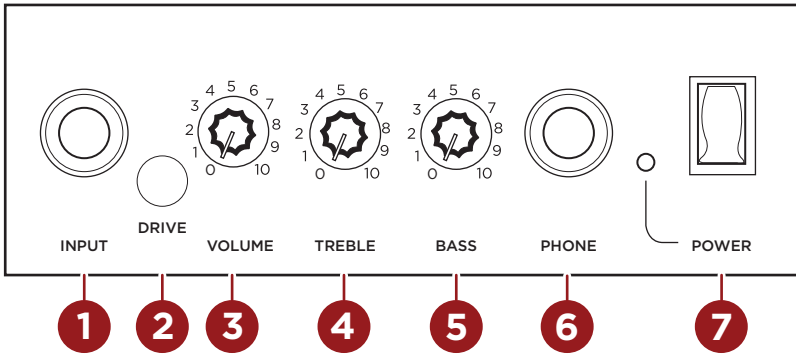

- |   |   |
|---|---|
| 1. <b>INPUT</b><br>Input jack for your guitar. Plug in your guitar here with an instrument cord | 5. <b>BASS</b><br>Adjusts the low-frequency note range    |
| 2. <b>DRIVE</b><br>Turns overdrive on/off. Controls the "distortion" effect                     | 6. <b>PHONE</b><br>Output jack for speakers or headphones |
| 3. <b>VOLUME</b><br>Adjusts the master volume level   | 7. <b>POWER</b><br>On/Off switch                          |
| 4. <b>TREBLE</b><br>Adjusts the high-frequency note range                                       |   |

# GUITAR STRING MAINTENANCE

## If strings are difficult to play or do not play correctly:

Replacing guitar strings can remedy many problems involving poor sound. All strings can be changed at once or strings can be changed individually. To change a guitar string, the old string should be completely removed before attaching the new string. After the new string is attached, the guitar will need to be re-tuned.

## CHANGING STRINGS

### Removing Old Strings:

- To remove a guitar string, first, find the tuning machine and tuning peg that the string is attached to. Loosen the string by winding the tuning peg until the string has no tension.
- Continue to wind the string loose until the string can be pulled loose from the top. The strings can be pulled out via the bridge at the bottom of the guitar.
- If you do not wish to use the old string again, you can cut the string near the middle of the strings via wire cutters. If you choose to do this, be careful and hold the string securely next to the cut; otherwise, the string may pop up and can potentially harm you.

### Installing New Strings:

- Attach strings to the bridge of your guitar. Locate the proper string to replace your old string. Then, from the end of the string that does NOT have a ball at the end, feed the string through the bridge via the open hole. The string should be pulled through until the ball is secure at the bottom of the bridge.
- Secure the string to the headstock end of your guitar via the tuning machine. To do so, make sure the eye/hole of the tuning machine is parallel to the neck/headstock of the guitar. Feed the string through the eye of the tuning machine, and pull the string fairly taut. The string should have a bit of slack (about 1-2 inches).
- Secure the string to the tuning machine by winding the part of the string that has come out through the tuning machine back underneath the part of the string that is running between the bridge and tuning machine. Then, pull the string back up and over the string running through the tuning machine (see diagram). The string should now be secure.
- Begin to tune the string, winding the tuning peg until the desired sound is produced. After hearing the desired tune, pull the string lightly. The string will go slightly out of tune. Readjust the tuning peg until receiving the desired tune again. Repeat the process a few more times. This will ensure that your string will stay in tune while playing.
- You may cut off the excess string, but it is important to leave some excess still attached (about ¼-1 inch) in case the guitar string needs to be restrung again. Remember, it is easy to cut more off later, but impossible to add string back.

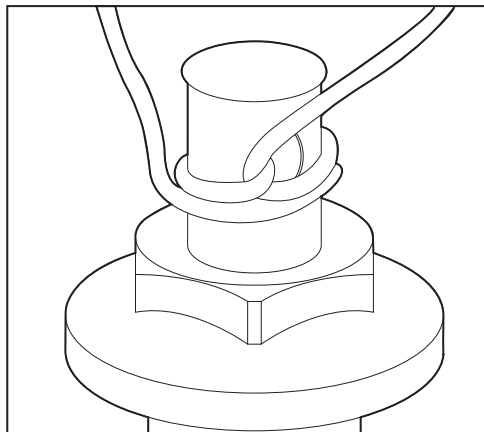

## CHANGING STRINGS

### Adjusting String Action:

If you feel that you have difficulty in fretting or hear a buzzing noise, the strings may be set too high or too low. In this case, the action (the space between the strings and the fretboard) will have to be adjusted. Adjusting the action will let you achieve the desired string level. This can easily be remedied by lowering or raising the string saddles located on the bridge. The saddles are the parts in front of the bridge where the strings sit. You can raise or lower the saddle by turning the hex screws on the saddle with a hex wrench. Turn the screw clockwise to raise the saddle and counterclockwise to lower it. If the saddle has two hex screws, be sure to turn them the same amount.

### Adjusting String Intonation:

If you notice that your strings are fretting sharp or fretting flat, or that your guitar is in tune near the bottom of the guitar but loses tune the further up the frets you go, you may need to adjust the intonation. First, determine if all strings are having the issue or a particular string. You can adjust the intonation of a string by moving the saddle away from the nut if the string is fretting sharp, and toward the nut if the string is fretting flat. Don't forget that adjusting the saddle for a string only corrects that string. You may need to adjust intonation for each string. Check the strings as you adjust the intonation to keep the guitar in tune.

### Adjusting Truss Rod:

The neck of your guitar can go out of adjustment, or you may want to readjust the neck to get a different sound. The neck on every guitar will eventually need to be readjusted – this is normal guitar maintenance. Inside the neck of the guitar is a “backbone” of the guitar: a truss rod. This rod helps keep your neck adjusted. If your strings are creating too high a sound and are hard to fret, or create a low, buzzing noise, these can signal the guitar neck needs adjustment. If the sound is too high and the strings are hard to fret, the truss should be tightened. If the sound is low or “buzzy,” it should be loosened.

You can adjust the truss rod with a nut located on one end. It should be located on the headstock, under a cap just behind the nut or where the neck joins the body under the fingerboard. You may need a truss-rod wrench to adjust it, which can be purchased at any local music store. To tighten the truss rod, turn the nut clockwise a quarter-turn at a time, giving the neck a few minutes to adjust. To loosen the truss rod, turn counterclockwise a quarter turn at a time, giving the neck a few minutes to adjust. Remember that over-tightening or over-loosening a truss rod can potentially damage the neck and body, so please do so with care!

## GUITAR HARDWARE & CARE

If there are any electrical components on your guitar which you think need to be fixed, please be aware that we recommend taking your guitar to your local music store to fix it. Beginner musicians and people unfamiliar with repairing the electrical parts of a guitar should not attempt to do so, especially without supervision.

If you hear any rattling or buzzing noises while playing, some hardware may be loose. You can tighten any hardware with the appropriate tool. It could be possible that a nut on the bridge post may be loose. If you hear a rattling noise, try strumming the guitar with one hand to re-create the noise while touching various parts with your other hand. The rattling should stop once you touch the affected part, and then you can tighten the part that is loose.

Dust and other foreign matter can harm the quality of your electric guitar. Make sure to regularly clean and maintain your guitar, including around the tuning pegs and bridge. Do not leave your guitar exposed to the elements, and be aware that guitars are sensitive to changes in temperature, humidity, and altitude.

Earn points while you shop. Join today!

bestchoiceproducts  
**rewards**

Join | Earn | Redeem

Give your friends 15% off their first order! For each successful referral you'll receive 100 points.

[bestchoiceproducts.com](https://bestchoiceproducts.com)



# HELP CENTER



Question about your product? We're here to help. Visit us at:

[help.bestchoiceproducts.com](http://help.bestchoiceproducts.com)



Chat Support



Product Inquiry



Orders FAQ



Product Assembly



Returns & Refunds

## PRODUCT WARRANTY INFORMATION

All items can be returned for any reason within 60 days of the receipt and will receive a full refund as long as the item is returned in its original product packaging and all accessories from its original shipment are included. All returned items will receive a full refund back to the original payment method. All returned items will not be charged a re-stocking fee.

All returned items require an RA (Return Authorization) number, which can only be provided by a Best Choice Products Customer Service Representative when the return request is submitted. Items received without an RA may not be accepted or may increase your return processing time. Once an item has been received by Best Choice Products, refunds or replacements will be processed within 5 business days.

All returns must be shipped back to the Best Choice Products Return Center at the customer's expense. If the reason for return is a result of an error by Best Choice Products then Best Choice Products will provide a pre-paid shipping label via email. Boxes for return shipping will not be provided by Best Choice Products, and is the customer's responsibility to either use the original shipping boxes or purchase new boxes.

Pictures may be required for some returns to ensure an item is not damaged prior to its return. Items returned are not considered undamaged until they are received by Best Choice Products and verified as such. All damages to items are the customer's responsibility until the item has been received by and acknowledged by Best Choice Products as undamaged.

© Best Choice Products, Inc. All rights reserved. Distributed by Best Choice Products, Inc. Tustin, CA 92780

## WARNING

Manufacturer and seller expressly disclaim any and all liability for personal injury, property damage or loss, whether direct, indirect, or incidental, resulting from the incorrect attachment, improper use, inadequate maintenance, unapproved modification, or neglect of this product.