



BEST CHOICE
PRODUCTS



INSTRUCTION MANUAL

Lighted 2D Christmas
Nativity Scene

! NOTICE

Please retain these instructions for future reference.



2 PERSON
ASSEMBLY



UP TO 20-30 MIN.
ASSEMBLY

- This product is intended for outdoor use and should be assembled outdoors only.
- This item is not intended for permanent installation or use.
- Unplug item when not in use or if left unattended.
- Ensure that your voltage is consistent with specifications.
- If any parts are missing, broken, damaged, or worn, stop using this product until repairs are made and/or factory replacement parts are installed.
- Do not use this item in a way inconsistent with the manufacturer's instructions as this could void the product warranty.
- This product is intended for residential use only.

! WARNING

- Do not plug into a wall outlet until item is fully assembled and lights are properly connected.
- Do not use in extreme weather conditions.
- This product contains glitter, do not assemble indoors to avoid unintended property damage and cleanup.
- Do not allow glitter to contact your eyes or face as this may result in skin irritation or injury.
- Keep item away from all heat sources (fireplace, stove, heater, etc.).
- Please use the provided stakes to properly secure the figures.
- Do not secure wiring with staples, nails, or sharp hooks.
- Do not hang ornaments or other objects from the cord.
- Unplug item before removing or changing bulbs.
- Replace burned-out bulbs immediately. Make sure to purchase bulbs of the same rated voltage and wattage.

HARDWARE

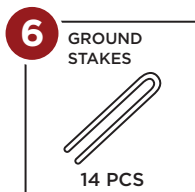
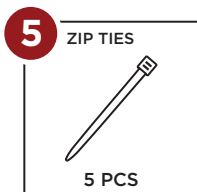
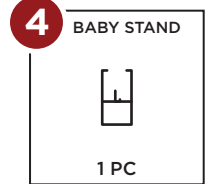
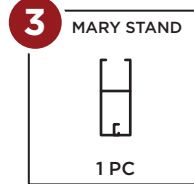
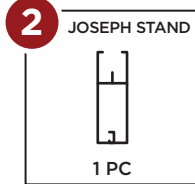
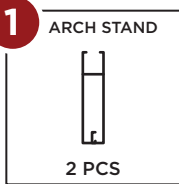

PARTS

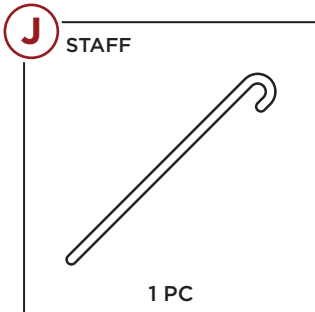
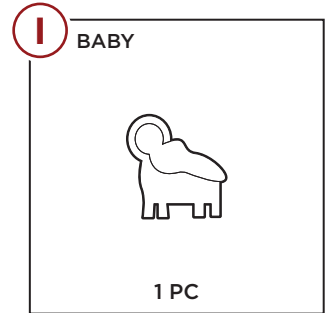
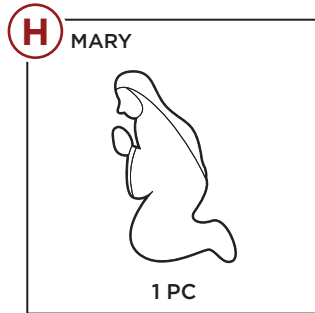
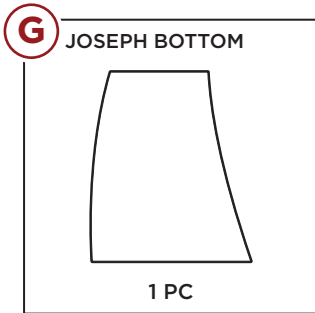
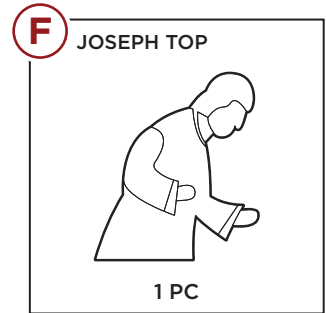
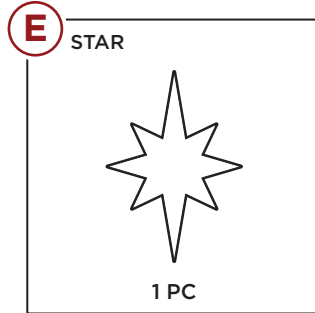
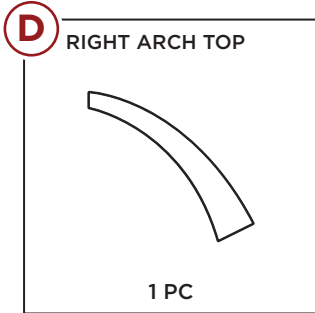
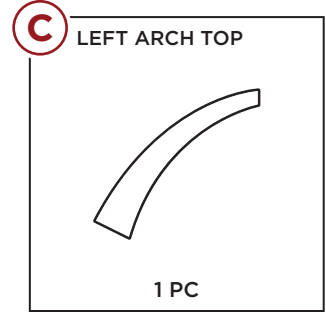
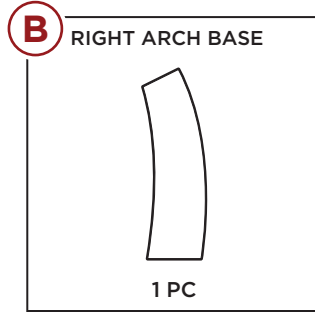
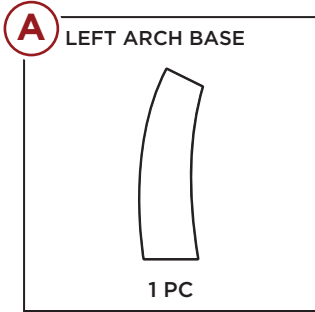

PRODUCT ASSEMBLY - ARCH

1

Attach the **part A left arch base** to the **part C left arch top** by threading pieces together, then secure with a **part 5 zip tie**.

Repeat to connect the **part B right arch base** to the **part D right arch top**.

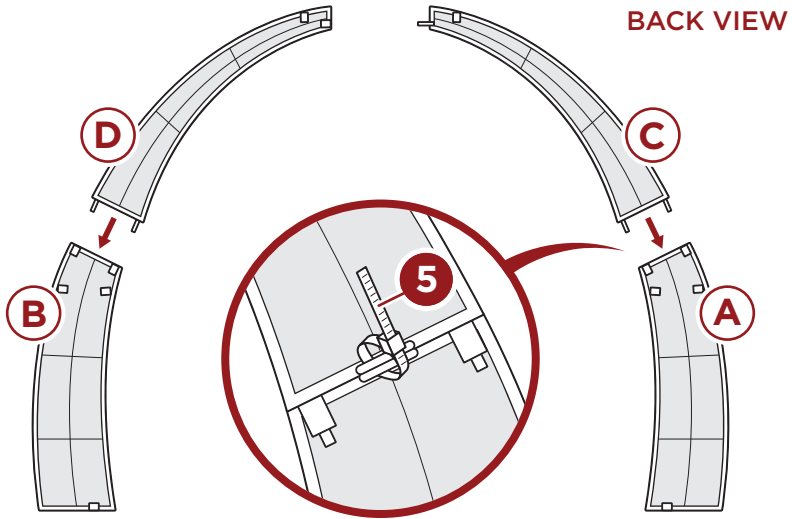

2

Attach one **part 1 arch stand** to the **part A left arch base**.

Attach one **part 1 arch stand** to the **part B right arch base**.

Lock the bottom of stand to the base of the arch, then lay the assembly face down.

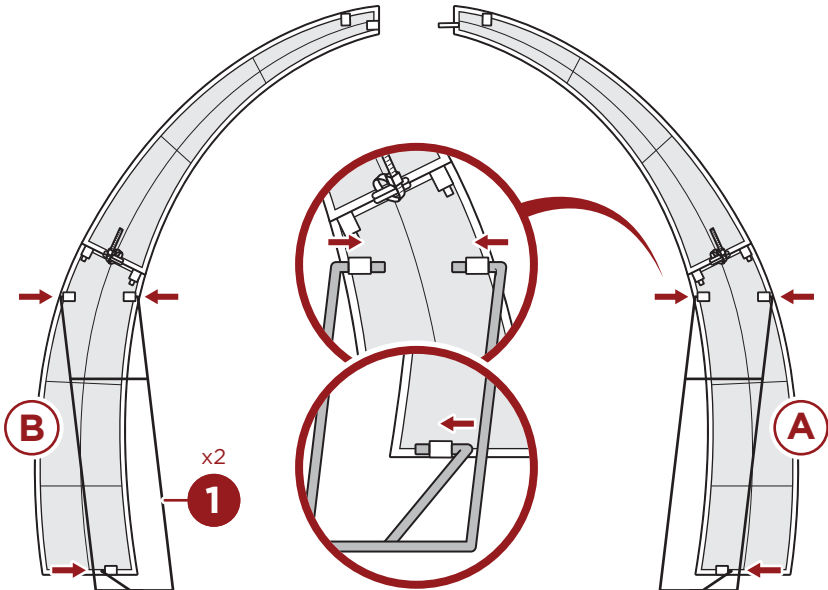

PRODUCT ASSEMBLY - ARCH

3

Interlock the **part C** and **D** arch tops and secure them together with one **part 5** zip tie.

Attach the **part E** star to the center of the two arch tops and secure with one **part 5** zip tie.

Plug in the cord on the **part E** star to the cord on the arch assembly, then with a second person, stand the arch up.

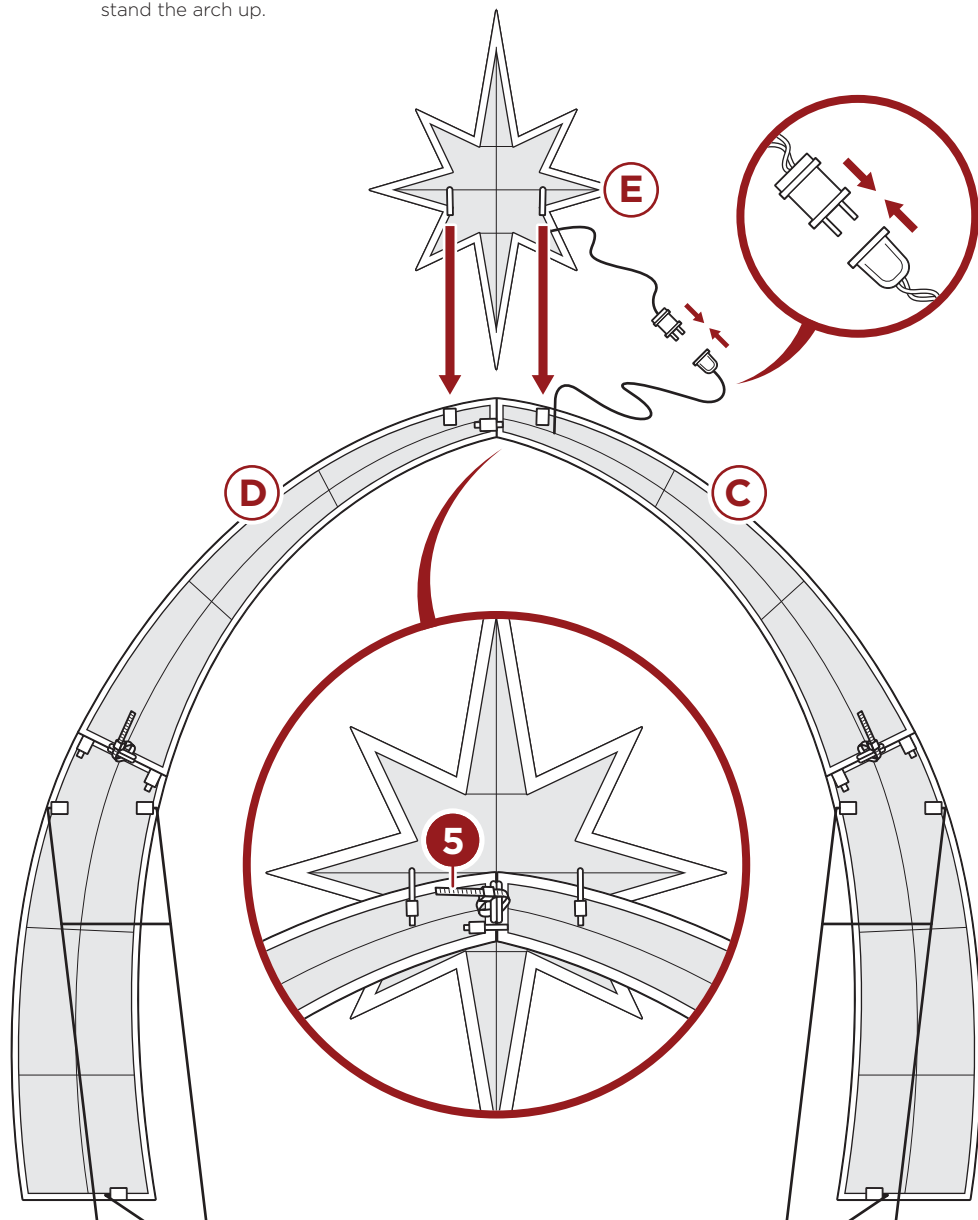

PRODUCT ASSEMBLY - FIGURES

1

Attach the **part F Joseph top** to the **part G Joseph bottom**, then secure with one **part 5 zip tie**.

Locate and attach the **part J staff** to the **part F Joseph top's** hand, secure with one **part 5 zip tie**.

Attach the **part 2 Joseph stand** to the Joseph assembly and connect the rod on the bottom of the stand to the base of the **part G bottom**.

Once secure, stand the assembled figure upright.

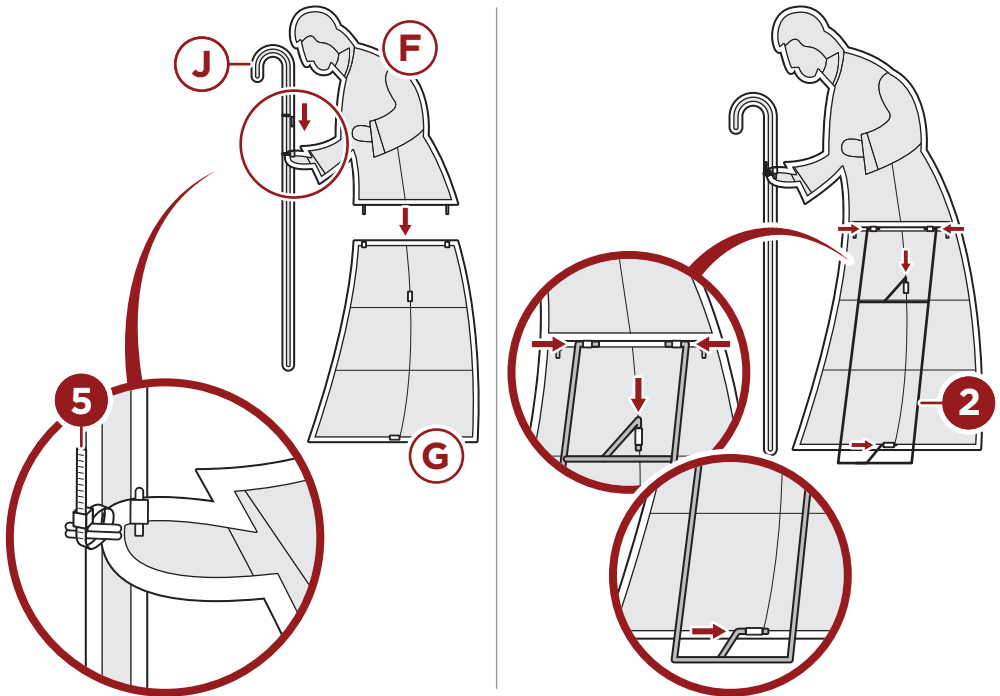

2

Attach the **part 3 Mary stand** to the **part H Mary figure**, then connect the rod on the bottom of the stand to the base of the Mary figure.

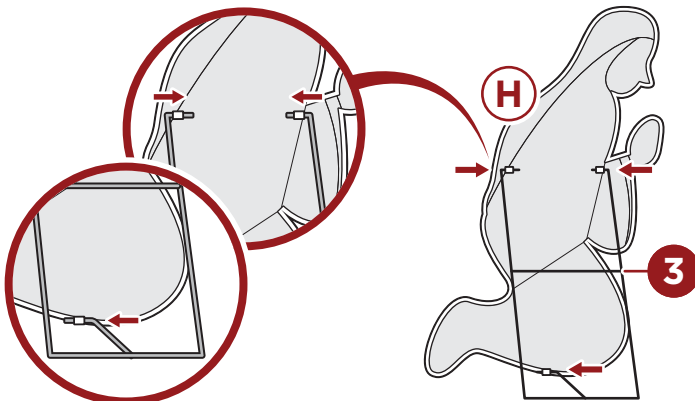

PRODUCT ASSEMBLY - FIGURES

3

Attach the **part 4 baby stand** to the **part 1 baby figure**, then connect the rod on the bottom of the stand to the base of the baby figure.

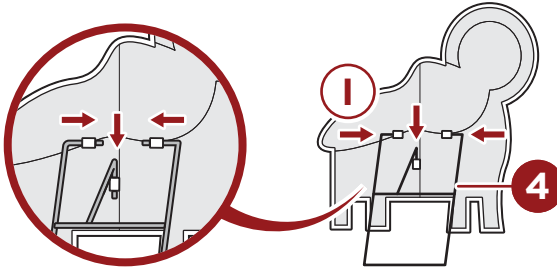

4

Arrange the figures and arch as desired, then connect each figure into the plugs on the arch assembly. Plug the arch into a wall outlet to turn the lights on.

Secure the arch bases and the figures to the ground with fourteen **part 6 ground stakes**.

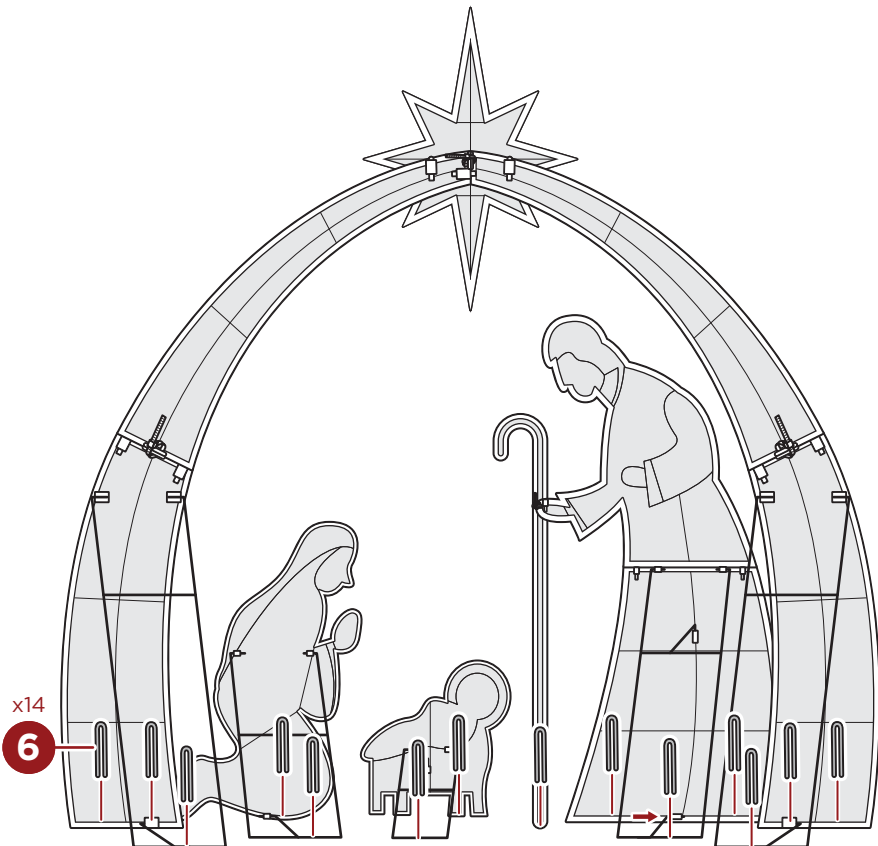



HELP CENTER



Question about your product? We're here to help. Visit us at:

help.bestchoiceproducts.com



Chat Support



Product Inquiry



Orders FAQ



Product Assembly



Returns & Refunds

PRODUCT WARRANTY INFORMATION

All items can be returned for any reason within 60 days of the receipt and will receive a full refund as long as the item is returned in its original product packaging and all accessories from its original shipment are included. All returned items will receive a full refund back to the original payment method. All returned items will not be charged a re-stocking fee.

All returned items require an RA (Return Authorization) number, which can only be provided by a Best Choice Products Customer Service Representative when the return request is submitted. Items received without an RA may not be accepted or may increase your return processing time. Once an item has been received by Best Choice Products, refunds or replacements will be processed within 5 business days.

All returns must be shipped back to the Best Choice Products Return Center at the customer's expense. If the reason for return is a result of an error by Best Choice Products then Best Choice Products will provide a pre-paid shipping label via email. Boxes for return shipping will not be provided by Best Choice Products, and is the customer's responsibility to either use the original shipping boxes or purchase new boxes.

Pictures may be required for some returns to ensure an item is not damaged prior to its return. Items returned are not considered undamaged until they are received by Best Choice Products and verified as such. All damages to items are the customer's responsibility until the item has been received by and acknowledged by Best Choice Products as undamaged.

© Best Choice Products, Inc. All rights reserved. Distributed by Best Choice Products, Inc. Tustin, CA 92780

WARNING

Manufacturer and seller expressly disclaim any and all liability for personal injury, property damage or loss, whether direct, indirect, or incidental, resulting from the incorrect attachment, improper use, inadequate maintenance, unapproved modification, or neglect of this product.