

Assembly Instructions



D2114-10 MARIANA RECTANGLE DINING TABLE

Thank you for purchasing this quality product. Be sure to check all packing materials carefully for small parts, which may have come loose inside the carton during shipment. Identify and count all items and compare with the PARTS LIST and/or HARDWARE LIST shown below.



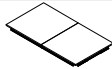

Caution: Please read the instructions thoroughly before assembly.

1. We recommend that you assemble this product with the assistance of another person; this will make the assembly easier, and will help eliminate damage to the product or injury to persons during assembly.
2. Please do not over tighten screws or bolts until the assembly is completed.
3. Please put all parts on a non-abrasive floor before assembly, and follow the assembly steps to assemble your newly purchased product correctly and efficiently.

PARTS LIST

NO:	COMPONENT	SKETCH	Q'TY
A	Table Top		1 PC
B	Leaf		1 PC
C	Leg		4 PCS

HARDWARE LIST

NO:	COMPONENT	SKETCH	Q'TY
1	Allen Key		1 PC
2	Bolt 5/16"*2-1/4"L		8 PCS
3	Lock Washer 5/16"		8 PCS
4	Flat Washer 5/16"		8 PCS

- STEP 1** Place the table top (A) upside down on a soft and clean surface. Assemble the legs (C) with the table top (A) by using Allen Key (1) with hardware 2,3, and 4.
****Attention: DO NOT TIGHTEN THE BOLTS.**

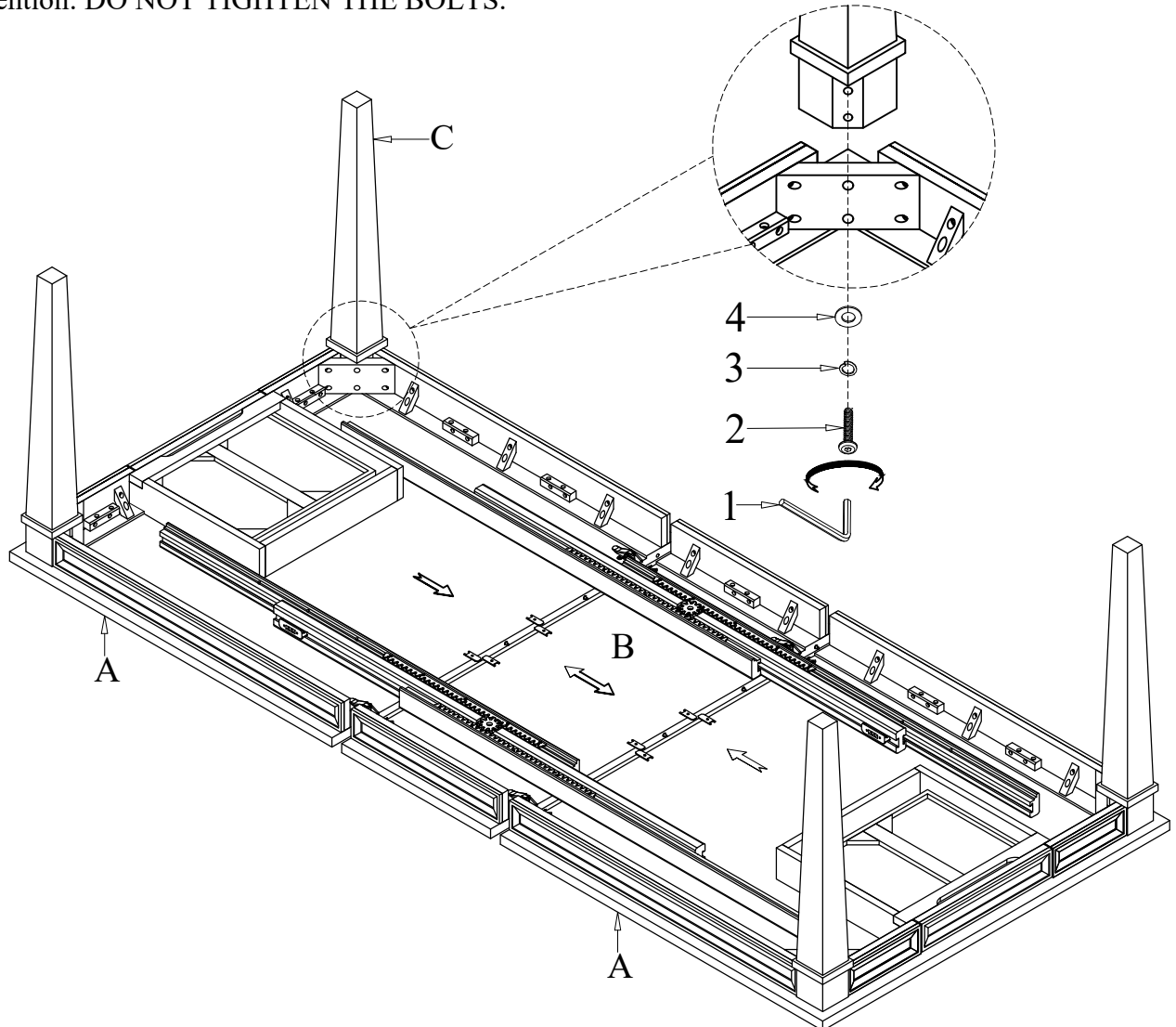

Assembly Instructions

D2114-10 MARIANA RECTANGLE DINING TABLE

STEP 2 To level the table, stand the table up on a flat surface and tighten all the bolts by using Allen Key (1).

