

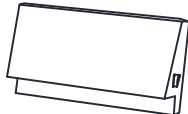





ASSEMBLY INSTRUCTION

LOVESEAT

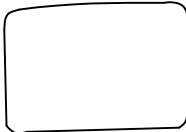
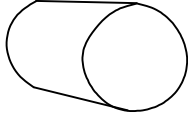
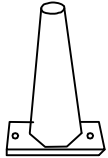
A Seat	B Back Frame	C Left Panel	D Right Panel	E Back Cushion
				
1pc	1pc	1pc	1pc	2pcs
F Pillow	G Leg	H Bolt M8*40mm	I Flat Washer M8	J Lock Washer M8
				
2pcs	4pcs	8pcs	8pcs	8pcs
K Allen Wrench 30mm*70mm				
				
1pc				

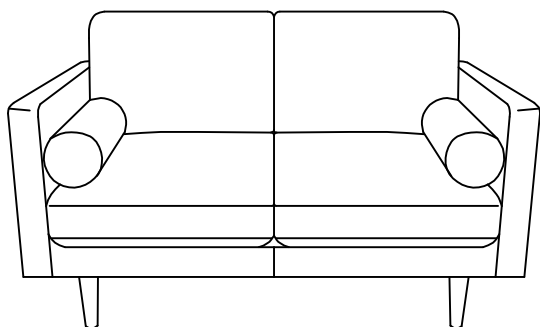

This page lists all the contents included in the box. Please take the time to identify the hardware as well as the individual components to this product. As you unpack and prepare for assembly, place the contents on a carpeted or padded area to protect them from damage.

1 Assemble Leg (G) to the bottom of Seat (A) with Bolt (H) & Flat Washer (I) & Lock Washer (J), then tighten with Allen Wrench (K).

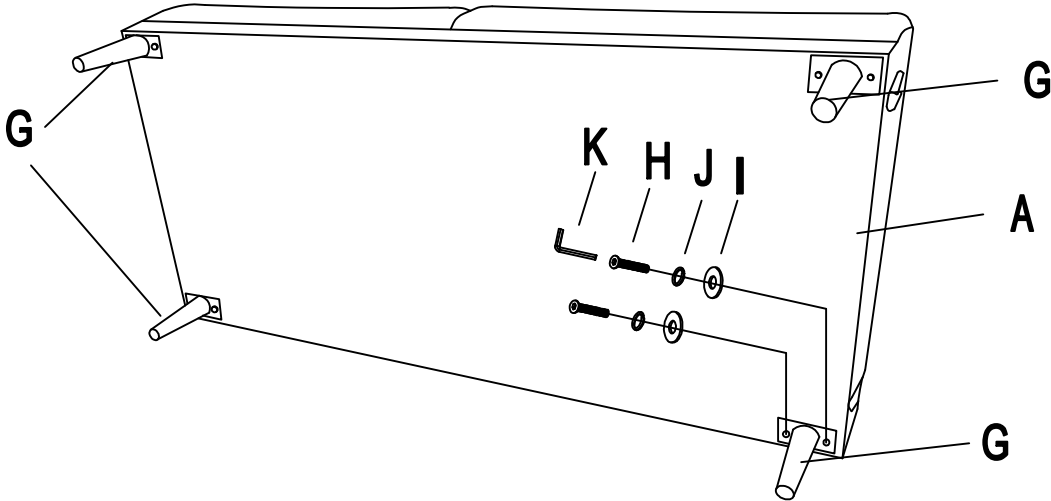

2 Hook on the Left Panel (C) & Right Panel (D) to Seat (A) properly.

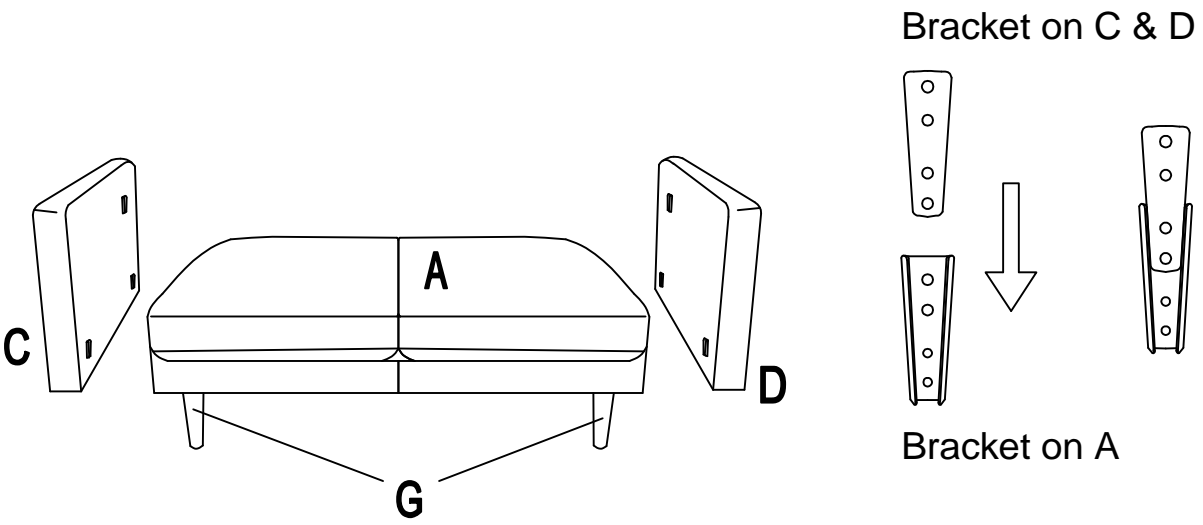

-
- 3** Hook on the Back Frame (B) to Left Panel (C) & Right Panel (D) properly.

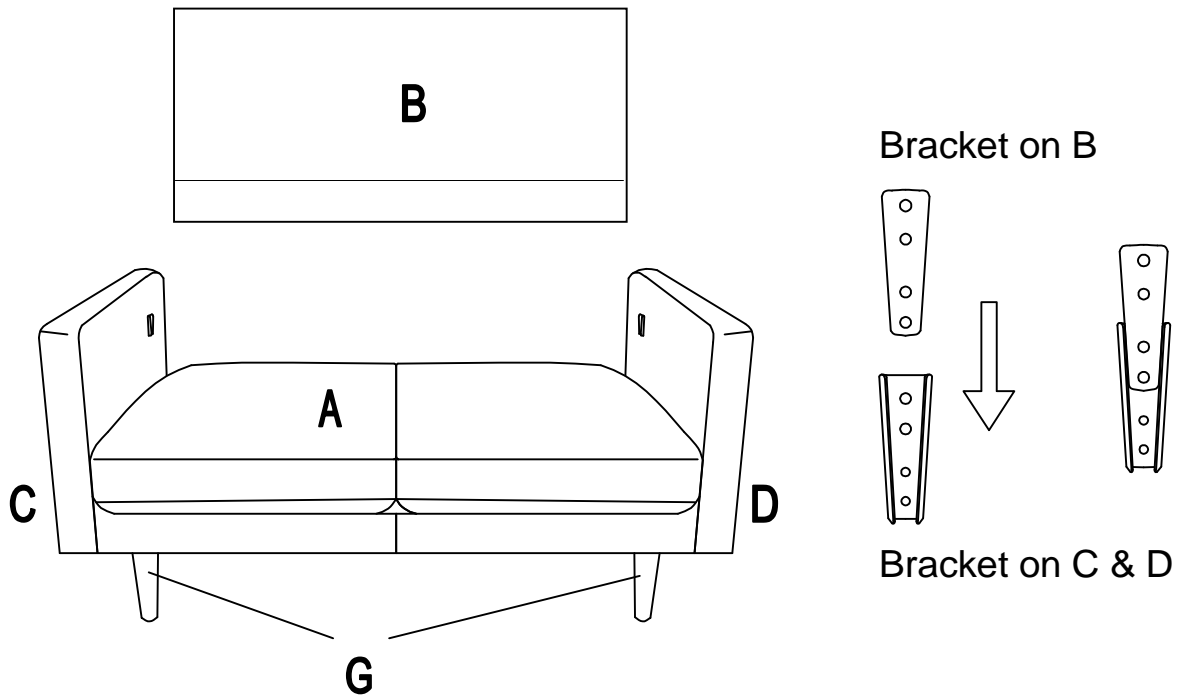

-
- 4** Place Pillow (F) and Back Cushion (E) on the loveseat correctly.

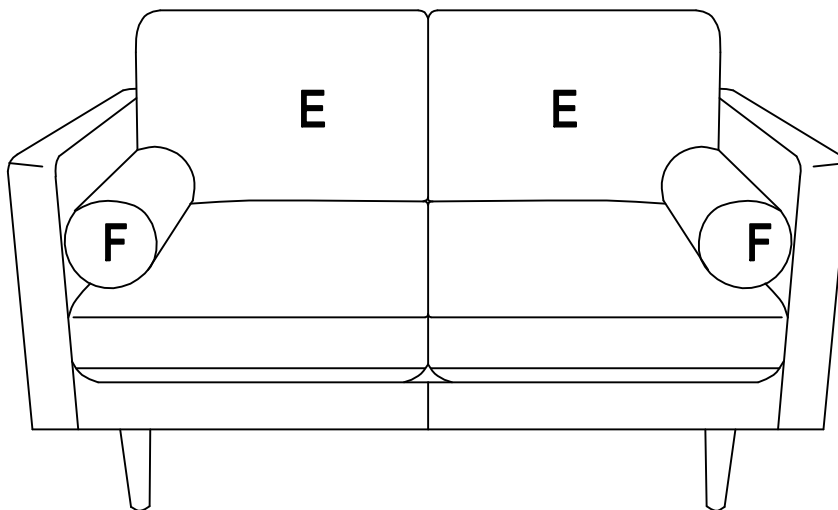

Cleaning & Care

Treat surface with care. Surface is resistant to scratches but is not scratch resistant. Clean surfaces with a dry or damp soft cloth. Do not use abrasive cleaners. Hardware may loosen over time. Periodically check that all connections are tight.