

# ASSEMBLY INSTRUCTION

## CHAIR

**A** Seat Frame

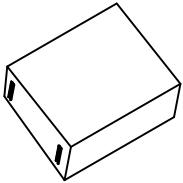

1pc

**B** Back Frame

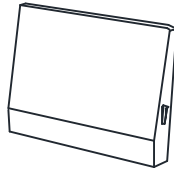

1pc

**C** Left Panel



1pc

**D** Right Panel



1pc

**E** Seat Cushion

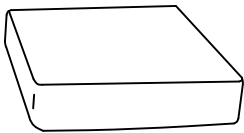

1pc

**F** Back Cushion

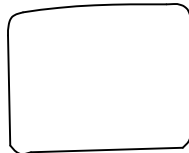

1pc

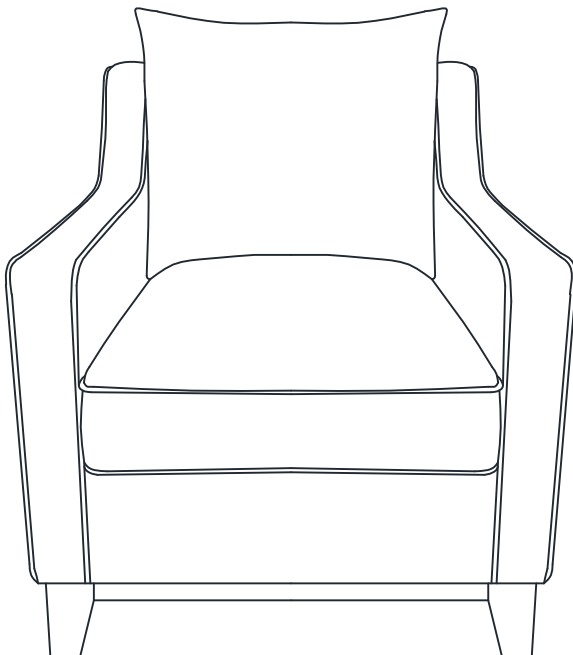

This page lists all the contents included in the box. As you unpack and prepare for assembly, place the contents on a carpeted or padded area to protect them from damage.

**1** Hook on the Left Panel (C) & Right Panel (D) to Seat Frame (A) properly.

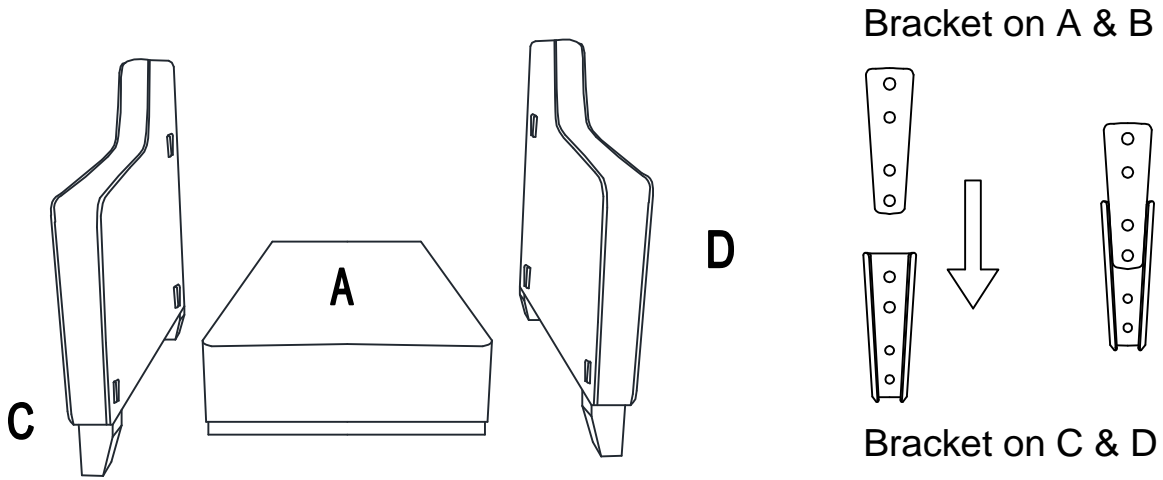

**2** Hook on the Back Frame (B) to Left Panel (C) & Right Panel (D) properly.

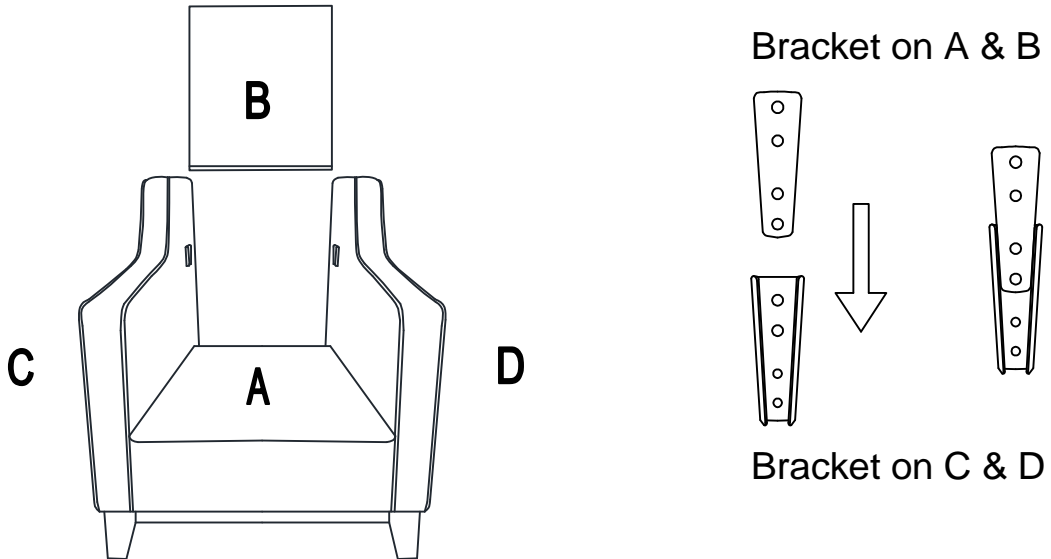

**3** Place Seat Cushion (E) and Back Cushion (F) on the chair properly.

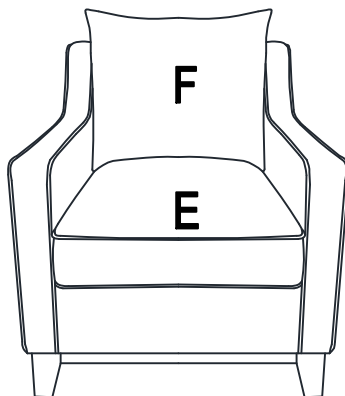

### Cleaning & Care

Treat surface with care. Surface is resistant to scratches but is not scratch resistant. Clean surfaces with a dry or damp soft cloth. Do not use abrasive cleaners.