

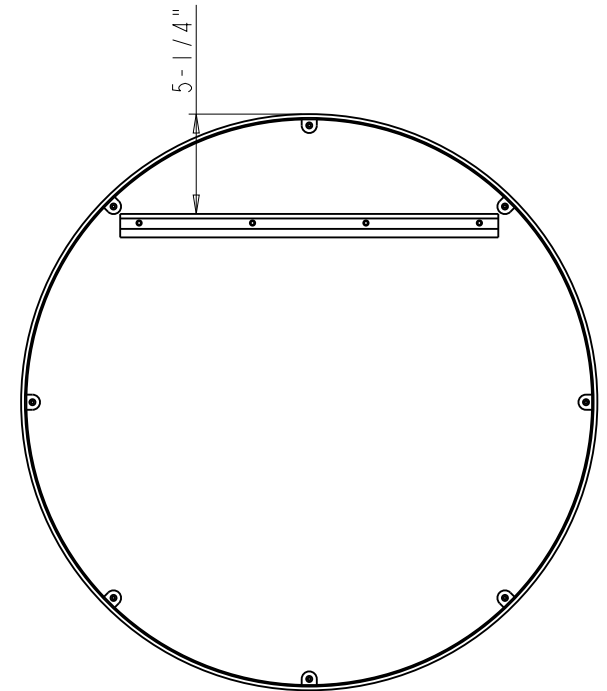

SECTION A-A

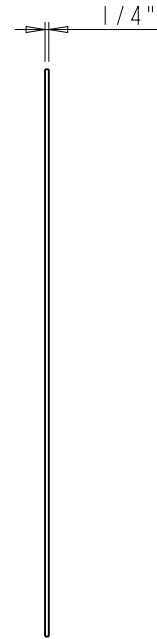
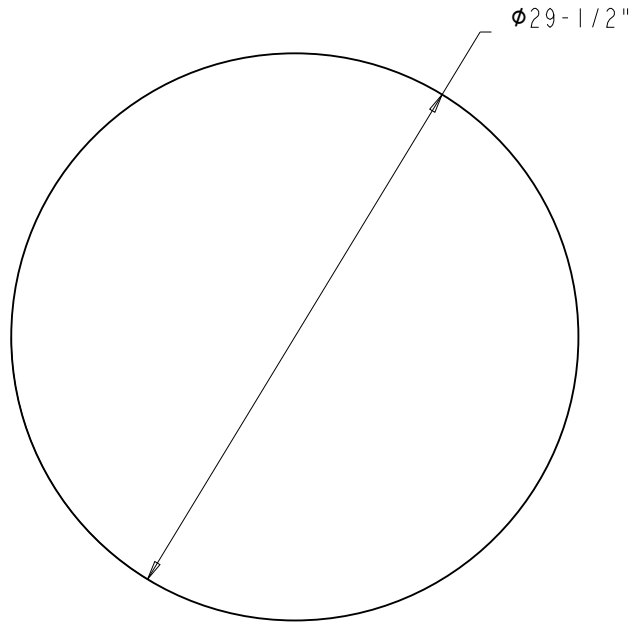

Item	Finish
VMIR-METC-30BG	Brushed Gold
VMIR-METC-30MB	Matte Black
VMIR-METC-30SBZ	Satin Bronze
VMIR-METC-30SN	Satin Nickel

<p>hardware resources</p> <p>PROPRIETARY AND CONFIDENTIAL</p> <p>THE INFORMATION CONTAINED IN THIS DRAWING IS THE SOLE PROPERTY OF HARDWARE RESOURCES INC. ANY REPRODUCTION IN PART OR AS A WHOLE WITHOUT THE WRITTEN PERMISSION OF HARDWARE RESOURCES INC. IS PROHIBITED.</p> <p>DO NOT SCALE DRAWING</p>	ITEM: VMIR-METC-30	MATERIAL:		
	FINISH:	WEIGHT:		
	TOLERANCE UNLESS OTHERWISE SPECIFIED: X ±0.20 X.X ±0.10 X.XX ±0.05 ANGULAR: ±0.5°	UNITS:	DRAWN BY: <i>Hugo.cai</i>	DATE: Feb-23-23
	SIZE:	APPROVED BY:	DATE:	
	SHEET:	RELEASE LEVEL:	REVISION:	



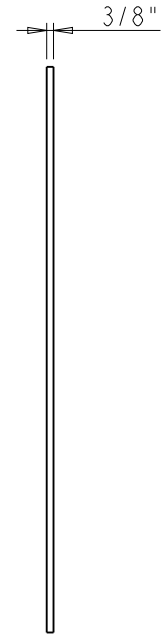
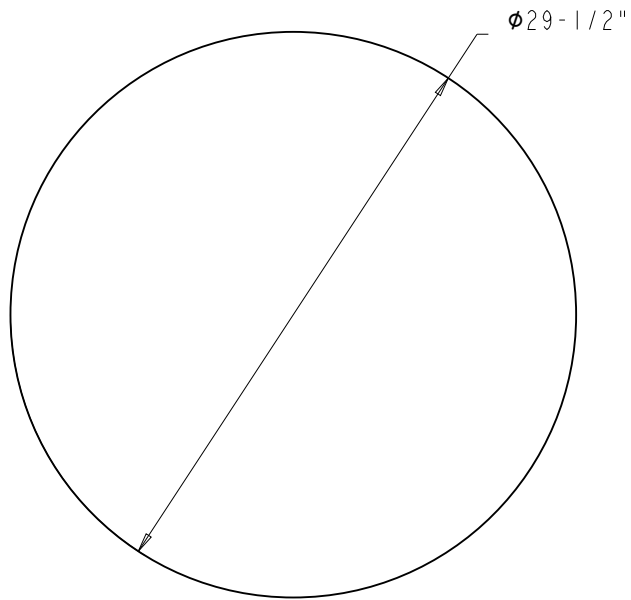

 hardware resources	ITEM#: VMIR-METC-30-MIRROR		MATERIAL:		
	FINISH:		WEIGHT: 9		
PROPRIETARY AND CONFIDENTIAL THE INFORMATION CONTAINED IN THIS DRAWING IS THE SOLE PROPERTY OF HARDWARE RESOURCES INC. ANY REPRODUCTION IN PART OR AS A WHOLE WITHOUT THE WRITTEN PERMISSION OF HARDWARE RESOURCES INC. IS PROHIBITED.	TOLERANCE UNLESS OTHERWISE SPECIFIED: X ±0.20 X.X ±0.10 X.XX ±0.05 ANGULAR: ±0.5°		UNITS:	DRAWN BY: <i>Hugo.cai</i>	DATE: Feb-23-23
	DO NOT SCALE DRAWING		SIZE:	APPROVED BY:	DATE:
			SHEET:	RELEASE LEVEL:	REVISION:
			PROJECTION 		



Note:

Material: MDF

 PROPRIETARY AND CONFIDENTIAL THE INFORMATION CONTAINED IN THIS DRAWING IS THE SOLE PROPERTY OF HARDWARE RESOURCES INC. ANY REPRODUCTION IN PART OR AS A WHOLE WITHOUT THE WRITTEN PERMISSION OF HARDWARE RESOURCES INC. IS PROHIBITED.	ITEM#: VMIR-METC-30-BACK-BOARD		MATERIAL:	
	FINISH:		WEIGHT: 9	
TOLERANCE UNLESS OTHERWISE SPECIFIED: X ±0.20 X.X ±0.10 X.XX ±0.05 ANGULAR: ±0.5° DO NOT SCALE DRAWING	UNITS:	DRAWN BY: <i>Hugo.cai</i>	DATE: Feb-23-23	
	SIZE:	APPROVED BY:	DATE:	
	SHEET:	RELEASE LEVEL:	REVISION:	
	PROJECTION 			

SEE DETAIL A 

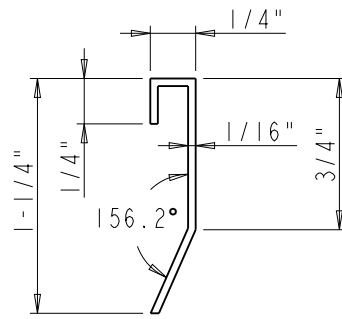
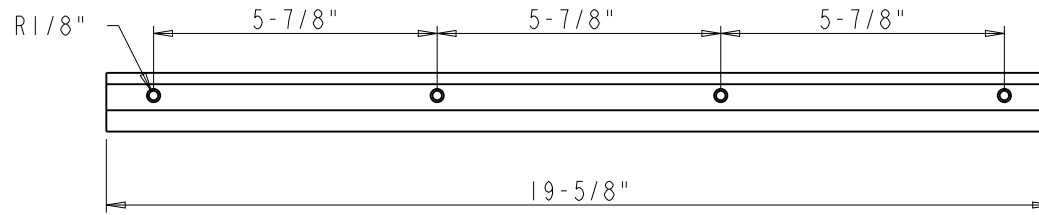

DETAIL A
SCALE 1:1

Note:

Material: Iron

 PROPRIETARY AND CONFIDENTIAL THE INFORMATION CONTAINED IN THIS DRAWING IS THE SOLE PROPERTY OF HARDWARE RESOURCES INC. ANY REPRODUCTION IN PART OR AS A WHOLE WITHOUT THE WRITTEN PERMISSION OF HARDWARE RESOURCES INC. IS PROHIBITED.	ITEM#: VMIR-METC-30-BRACKET		MATERIAL:		
	FINISH:		WEIGHT: 9		
	TOLERANCE UNLESS OTHERWISE SPECIFIED: X ±0.20 X.X ±0.10 X.XX ±0.05 ANGULAR: ±0.5°		UNITS:	DRAWN BY: <i>Hugo.cai</i>	DATE: Feb-23-23
	DO NOT SCALE DRAWING		SIZE:	APPROVED BY:	DATE:
		SHEET:	RELEASE LEVEL:	REVISION:	

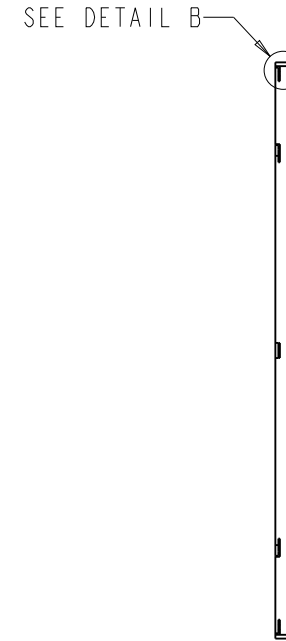
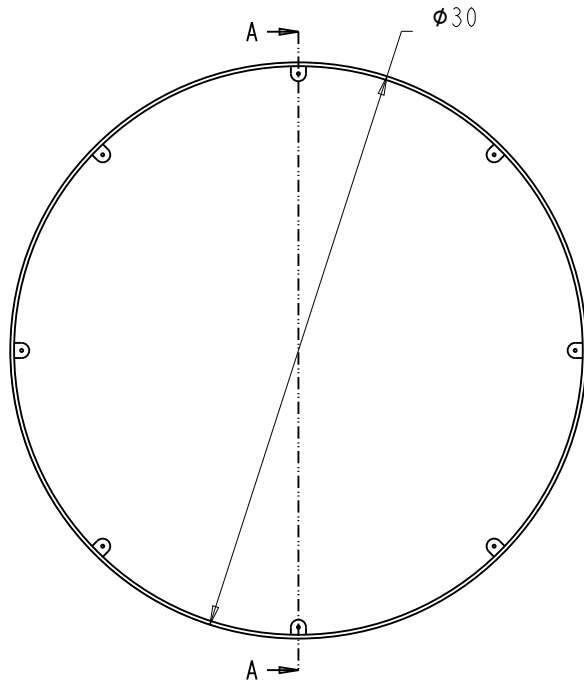

SECTION A-A

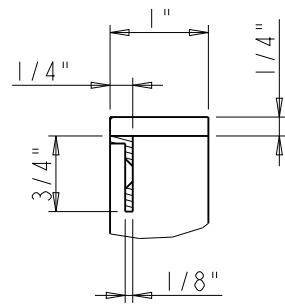

DETAIL B
SCALE 1:2

Note:

Material: Iron

	ITEM#: VMIR-METC-30-FRAME		MATERIAL:	
	FINISH:		WEIGHT:	
PROPRIETARY AND CONFIDENTIAL THE INFORMATION CONTAINED IN THIS DRAWING IS THE SOLE PROPERTY OF HARDWARE RESOURCES INC. ANY REPRODUCTION IN PART OR AS A WHOLE WITHOUT THE WRITTEN PERMISSION OF HARDWARE RESOURCES INC. IS PROHIBITED.	UNITS:		DRAWN BY: <i>Hugo.cai</i>	
	TOLERANCE UNLESS OTHERWISE SPECIFIED: X ±0.20 X.X ±0.10 X.XX ±0.05 ANGULAR: ±0.5°		DATE: Feb-23-23	
	SIZE:		APPROVED BY:	
	SHEET:		RELEASE LEVEL:	
DO NOT SCALE DRAWING		PROJECTION:		9
		DATE:		REVISION: