

1606036B MALIBU Container Loading Diagram

(1 set = 4 boxes, 20 pallets/40HQ, 55 sets/40HQ, Gross Weight: 16620kg)

Top View

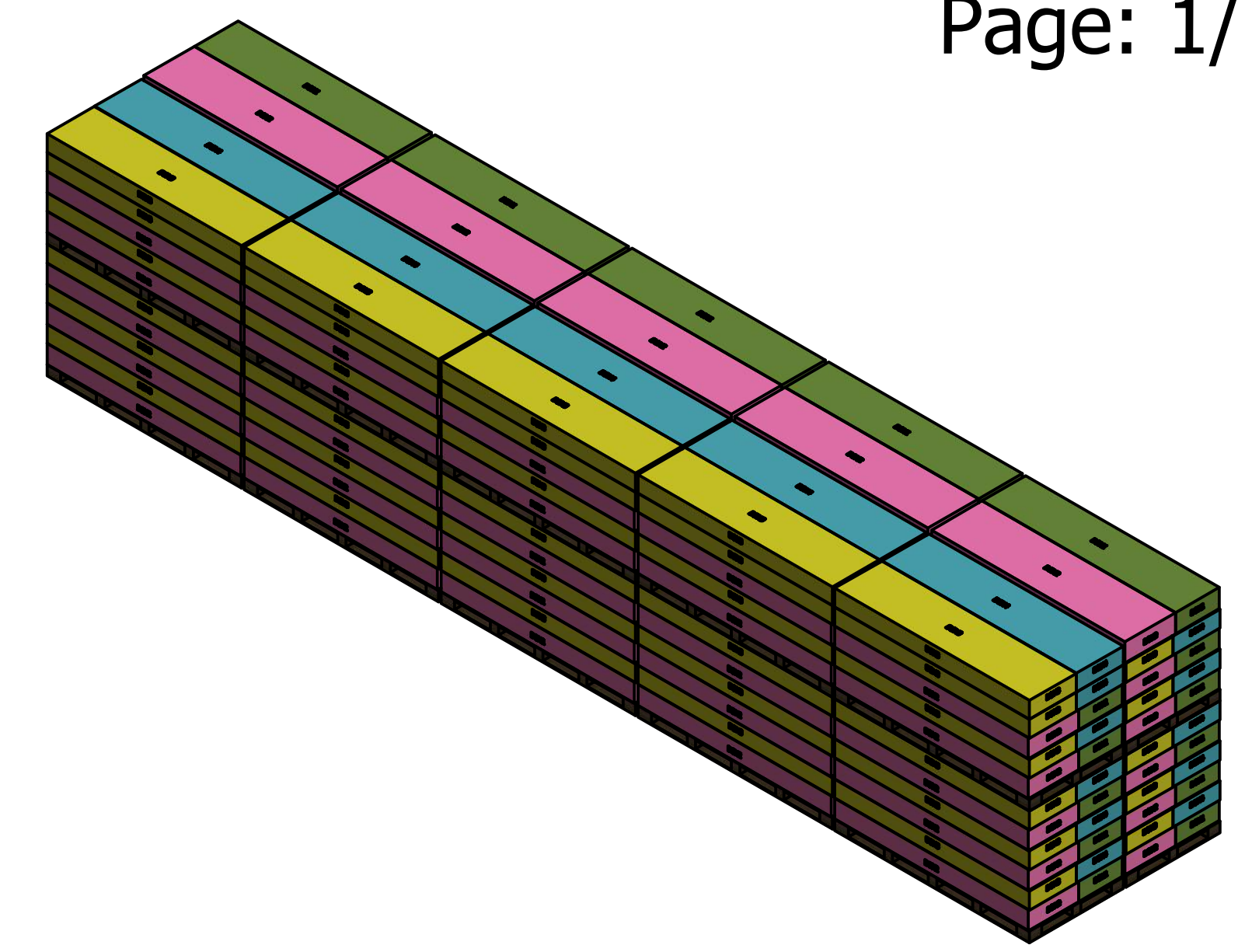
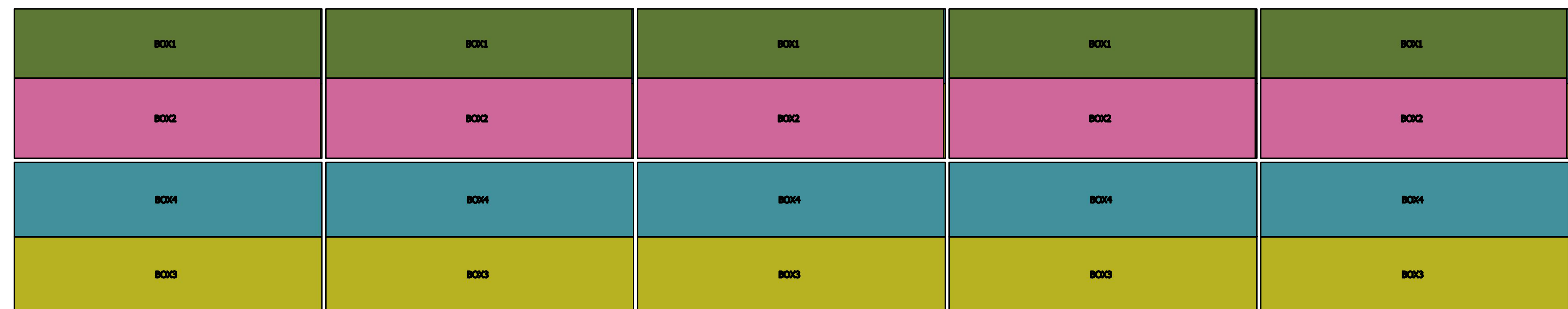

Side View

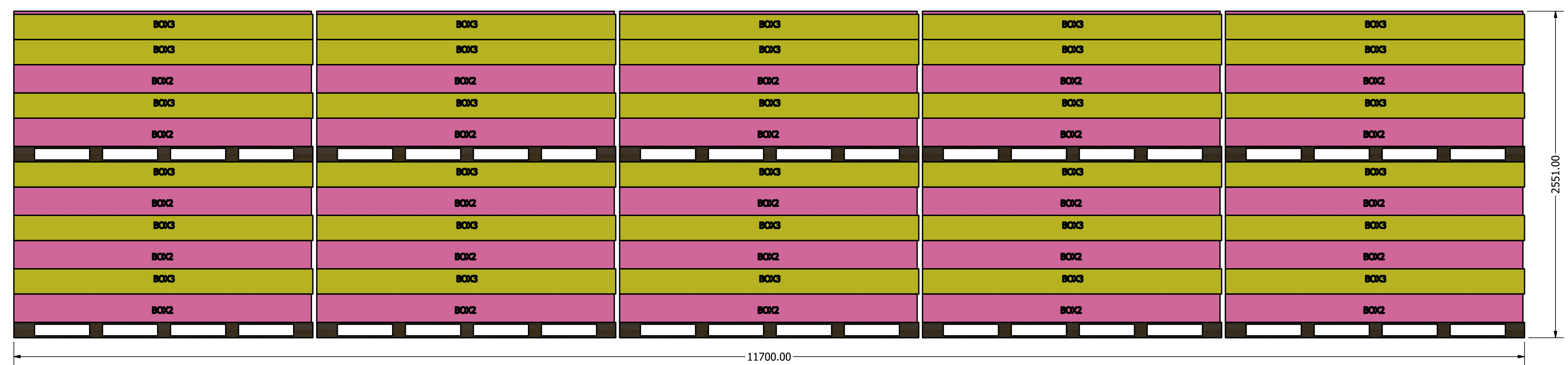

End View

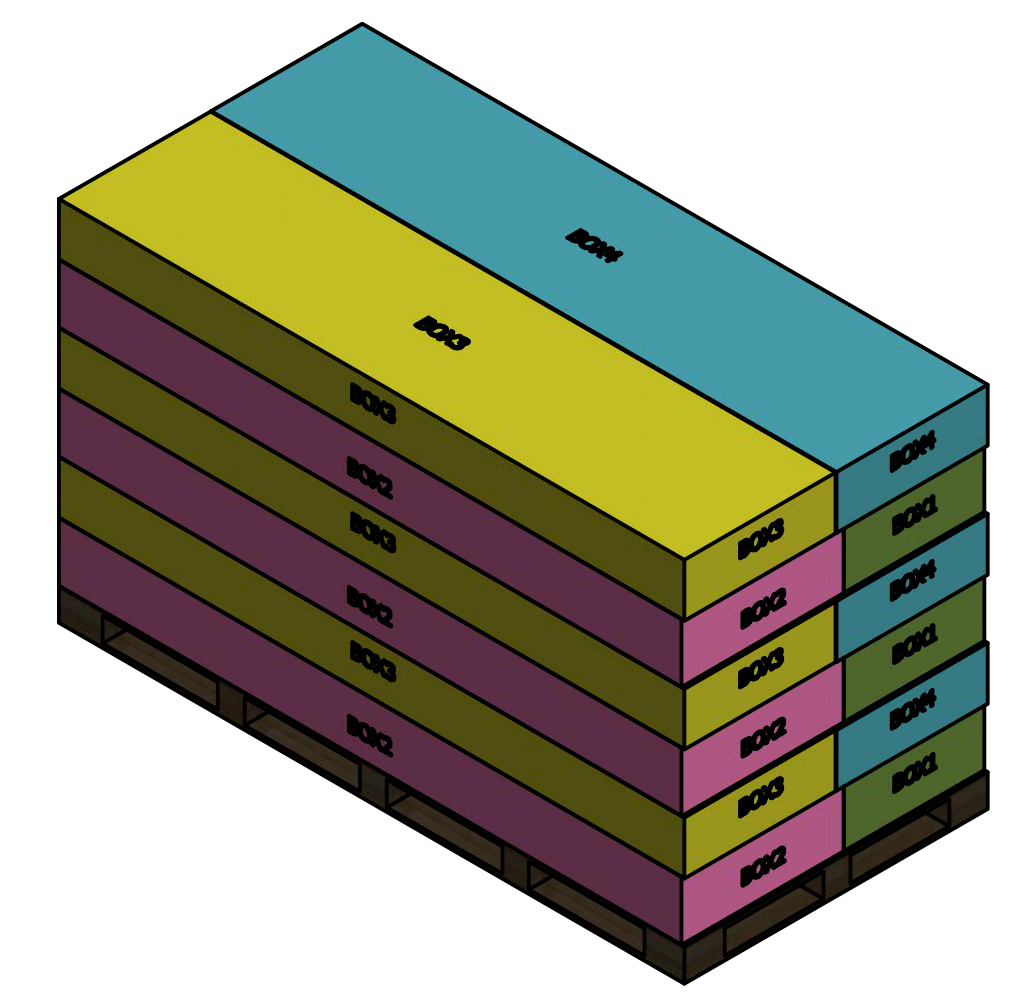
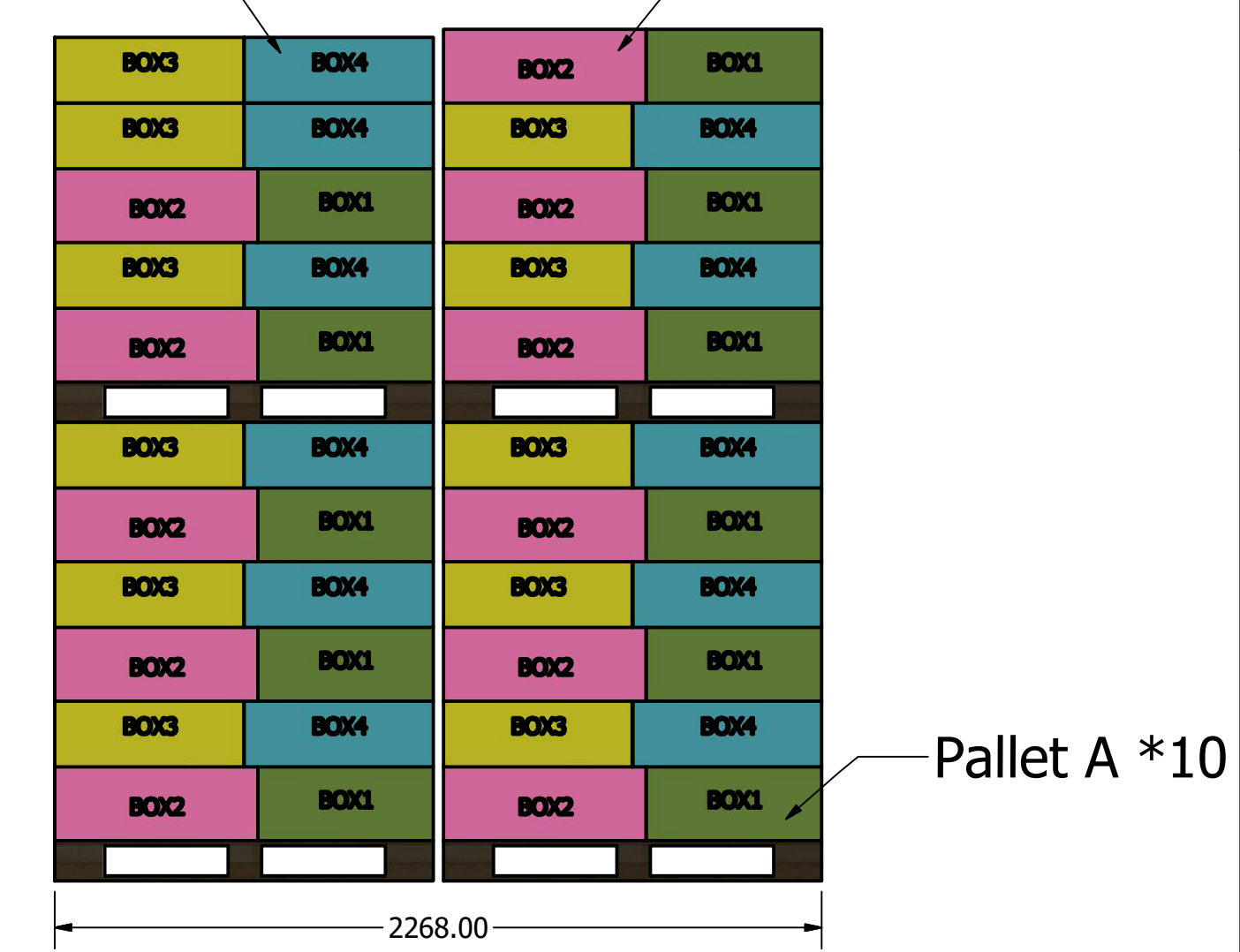

Pallet A * 10

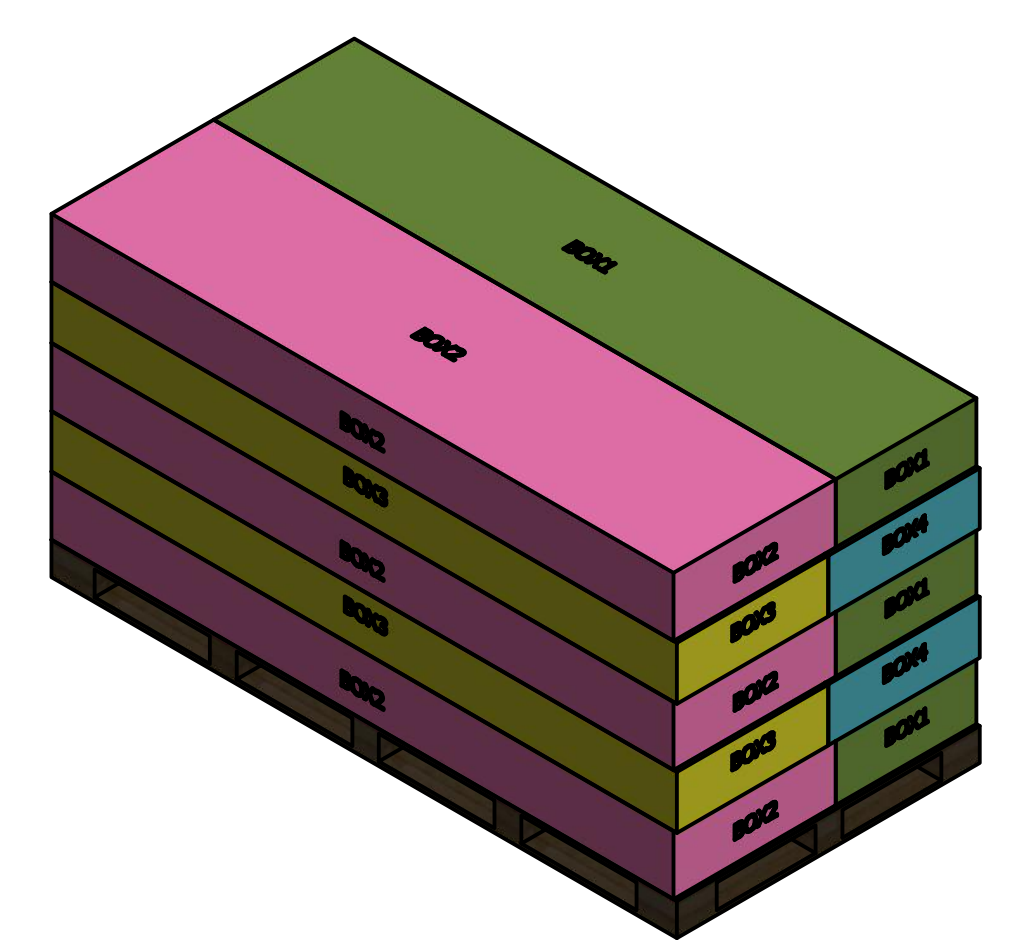

Pallet B * 5

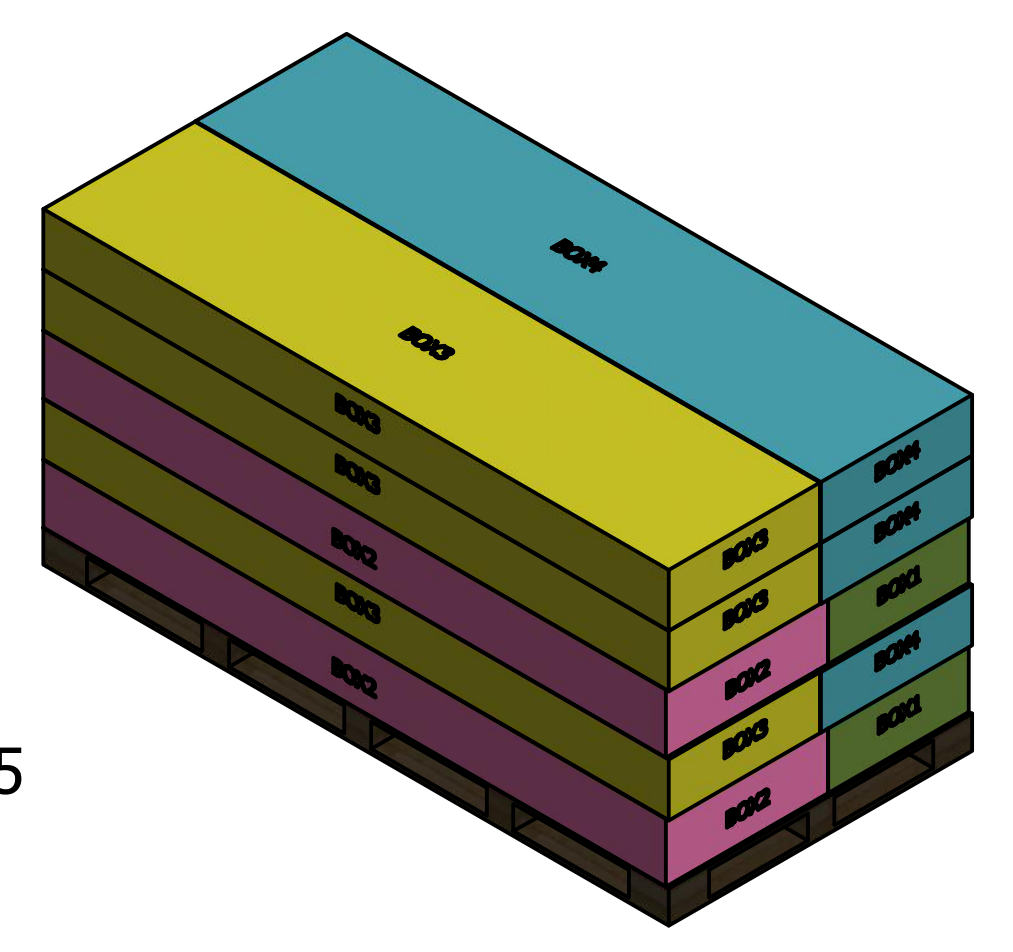

Pallet C * 5

DRAWN	Rudy	2021-5-11		
CHECKED			TITLE	
QA				
MFG				
APPROVED				
			SIZE	DWG NO
			D	6113-D
			SCALE	1 / 20
			SHEET 1 OF 1	

Pallet A (3 sets/pallet)

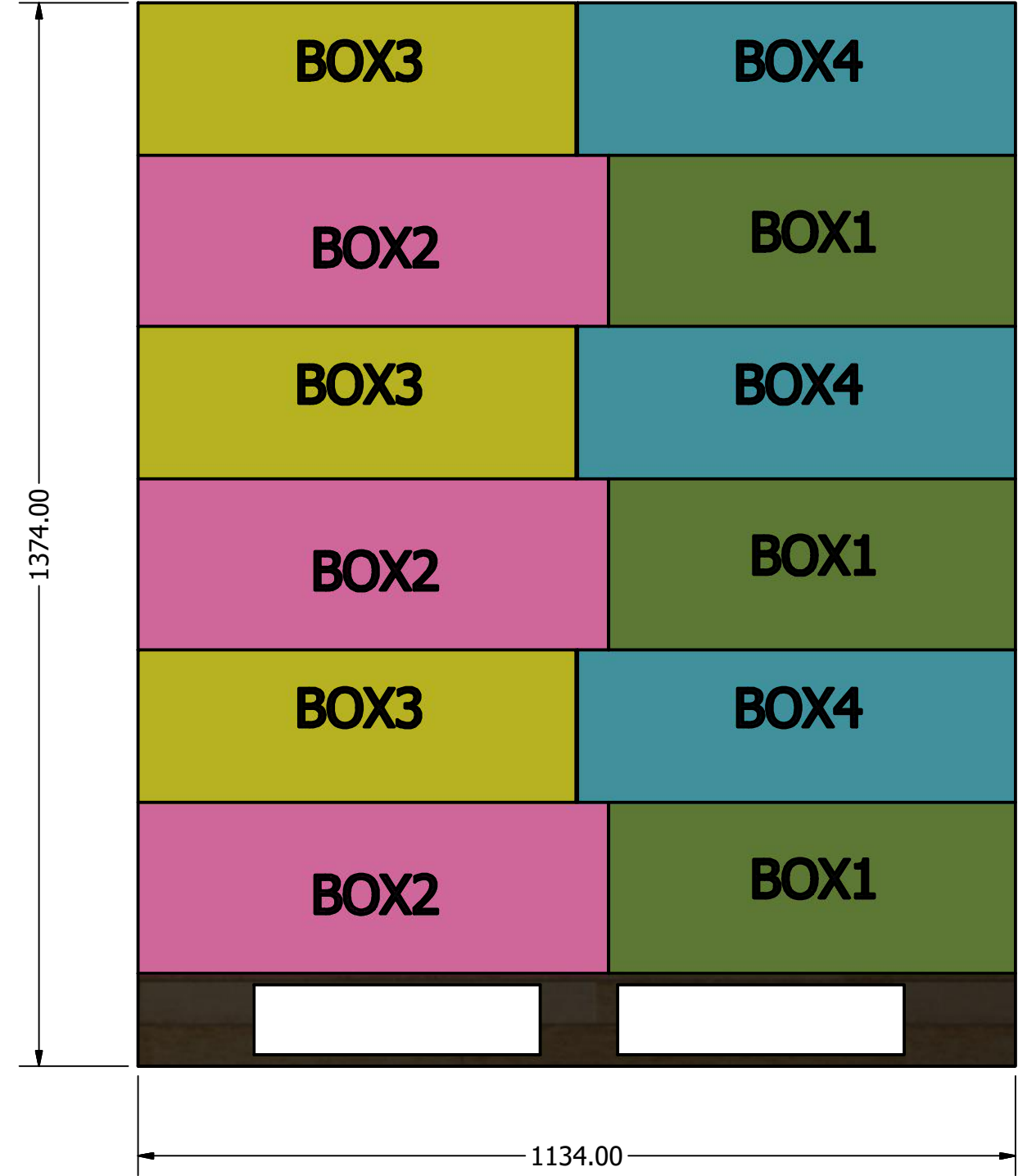
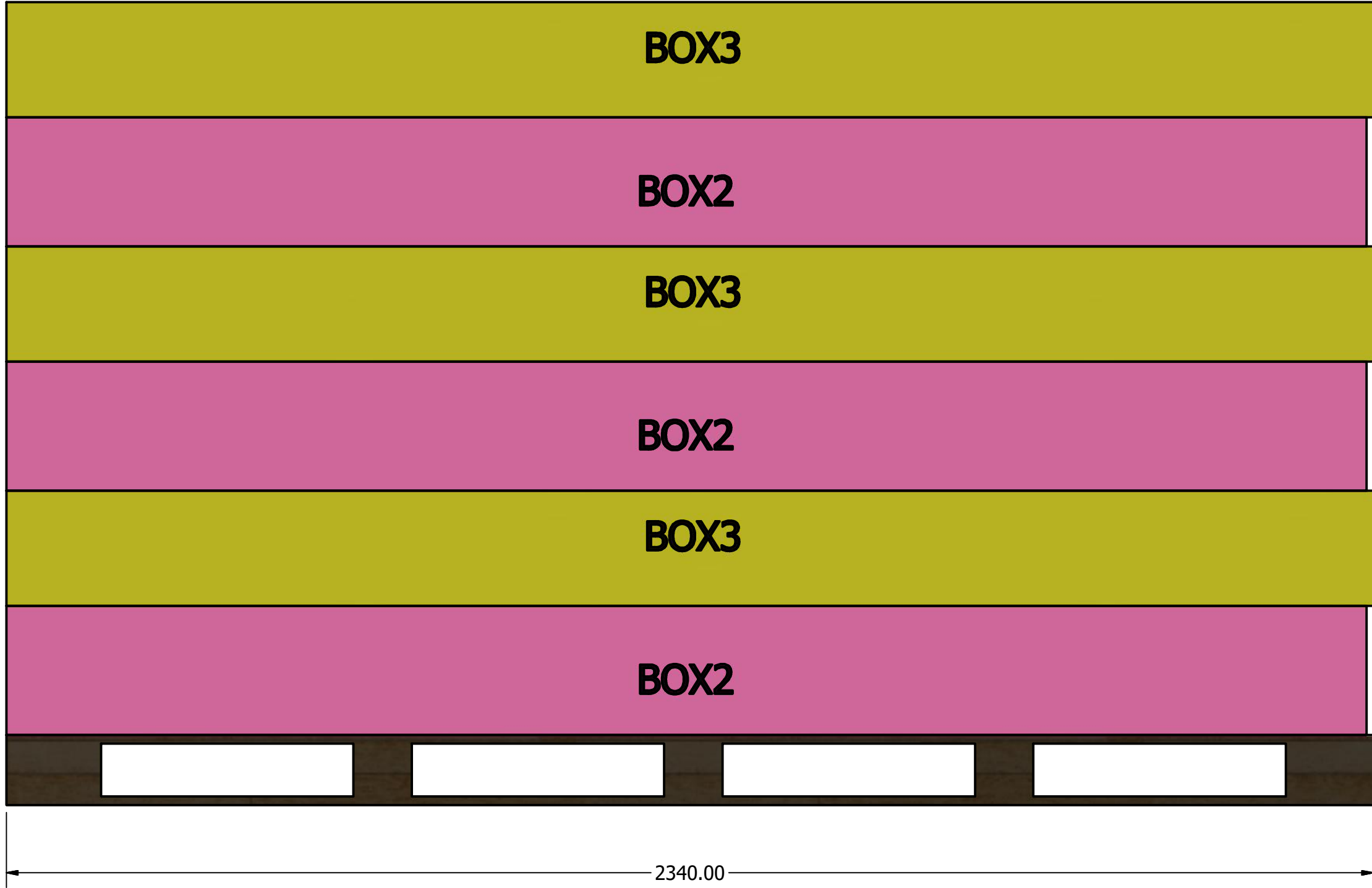
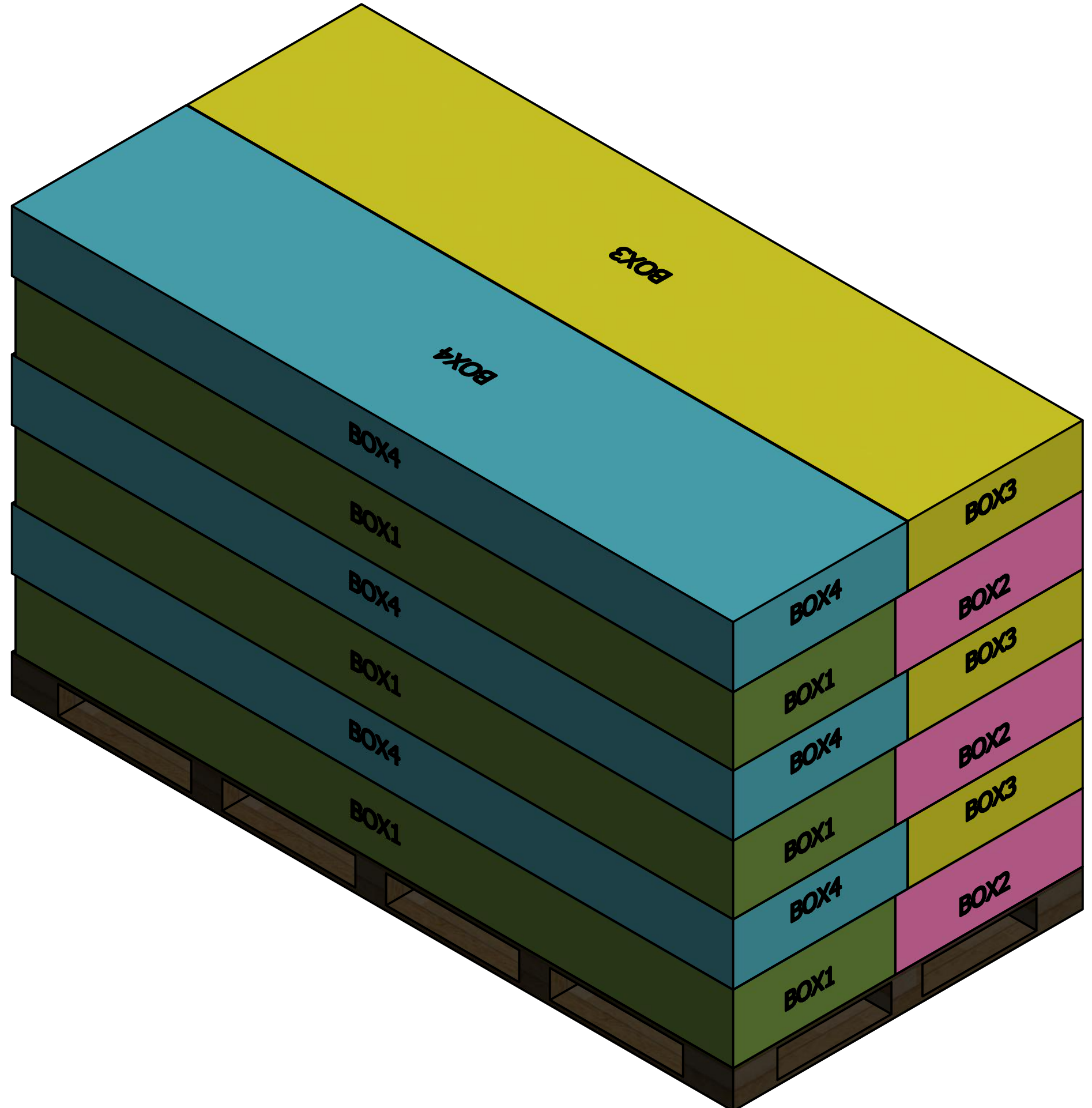
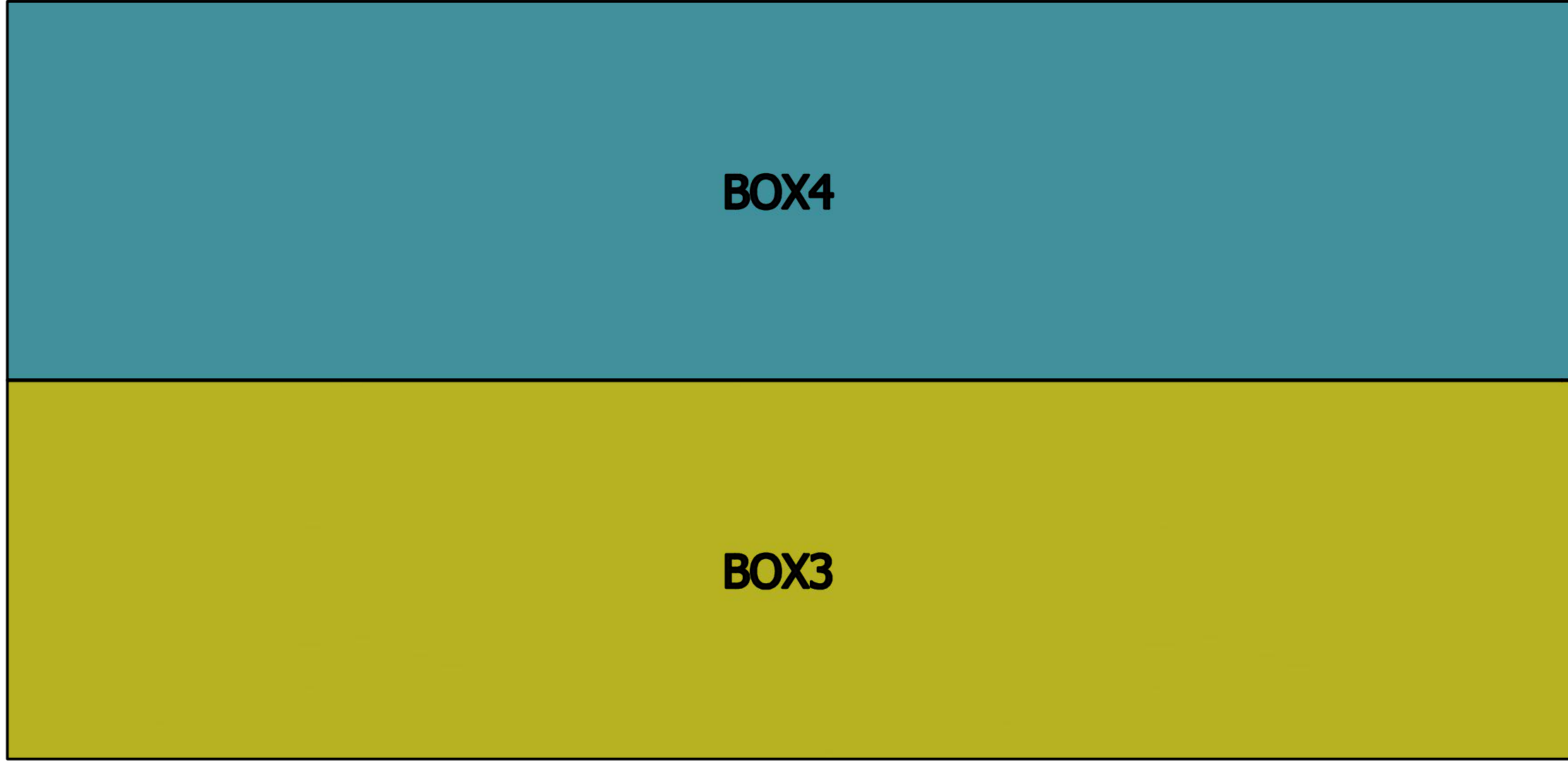

DRAWN Rudy	2019/8/19		
CHECKED		TITLE	
QA			
MFG			
APPROVED			
		SIZE D	DWG NO Pallet A
		SCALE 1 : 10	REV
		SHEET 1 OF 1	

Pallet B (2.5 sets/pallet)

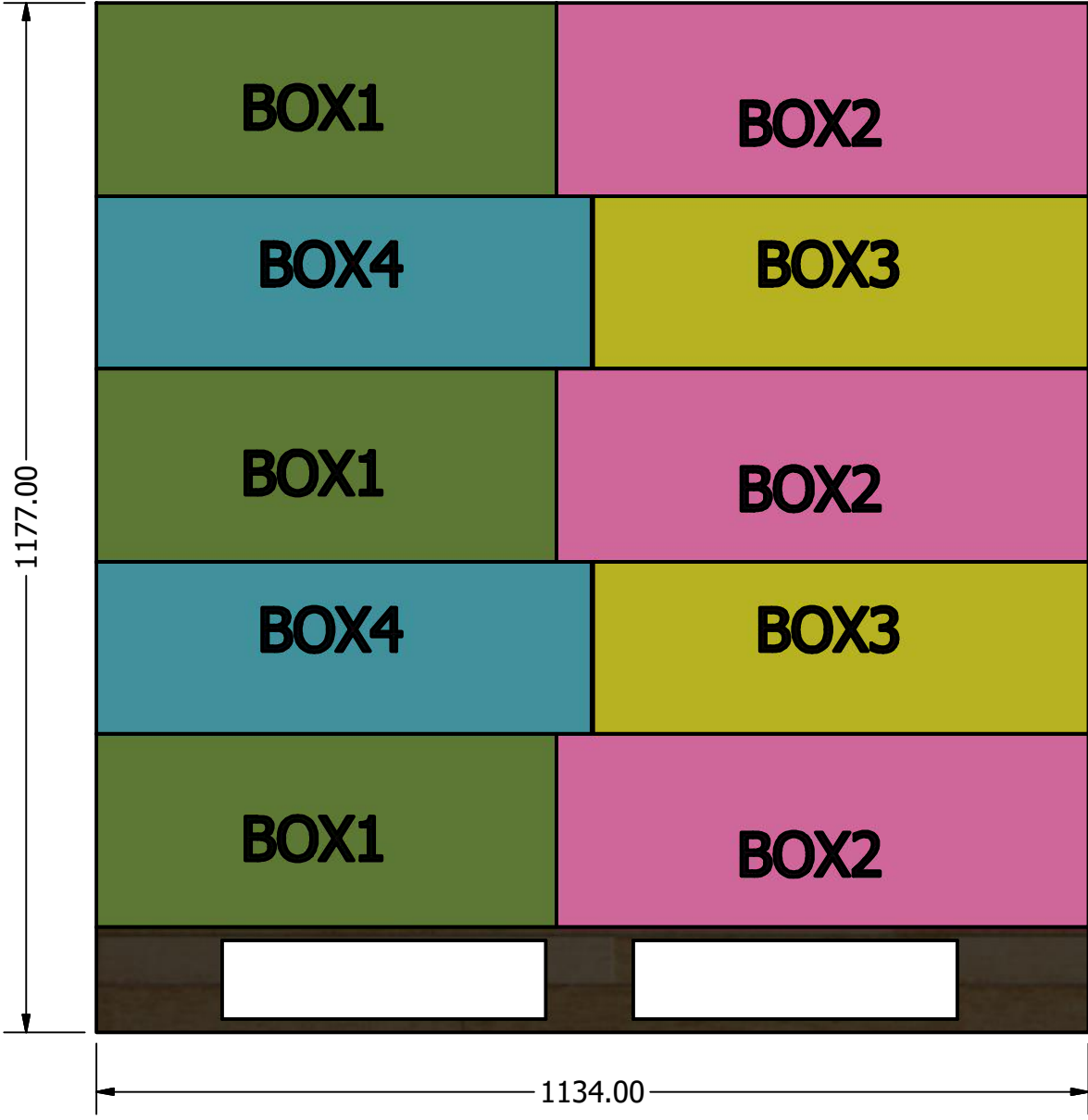
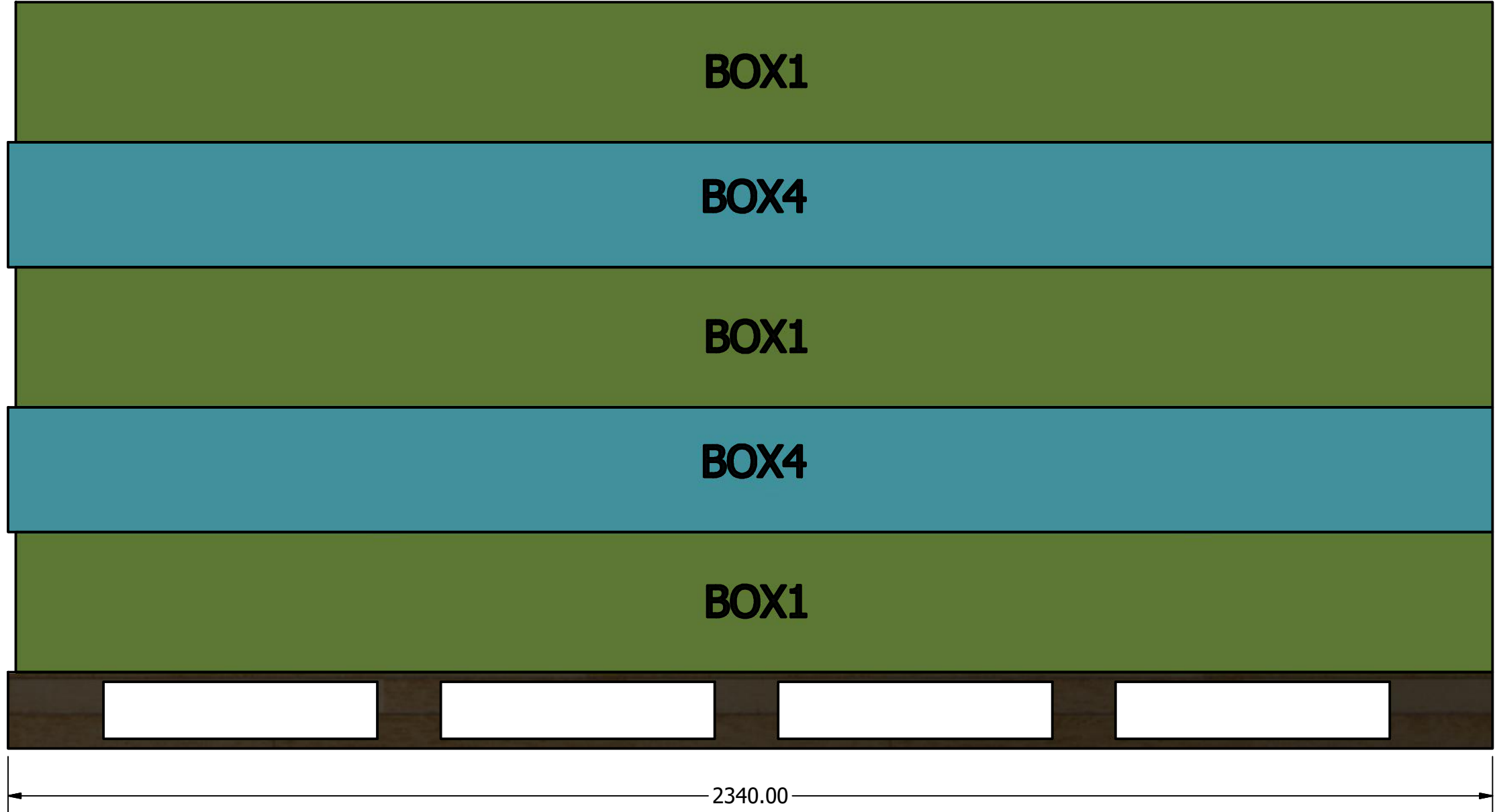
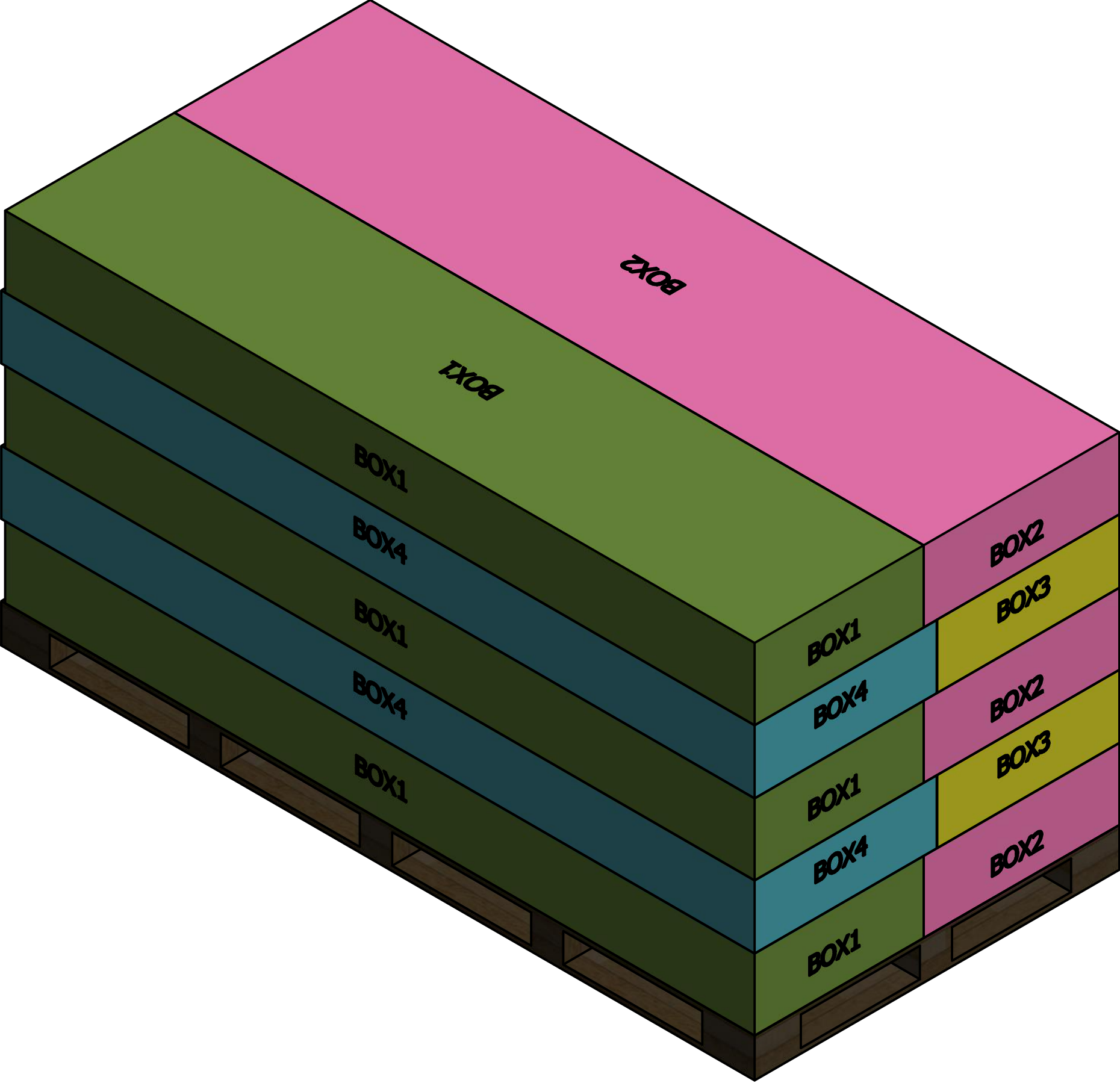
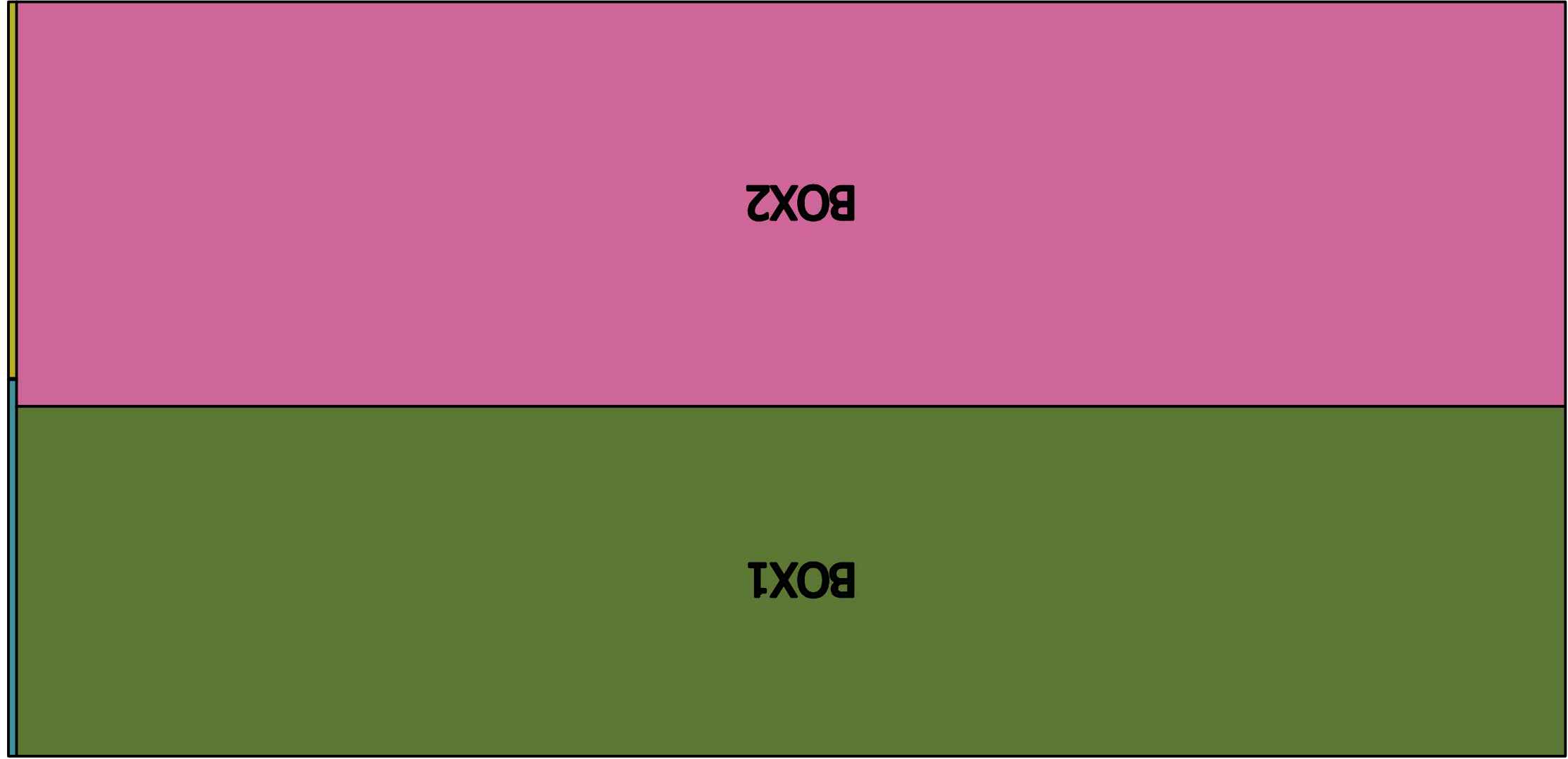

DRAWN Rudy	2019/8/19		
CHECKED		TITLE	
QA			
MFG			
APPROVED			
		SIZE D	DWG NO Pallet A
		SCALE 1: 8	REV
		SHEET 1 OF 1	

Pallet C (2.5 sets/pallet)

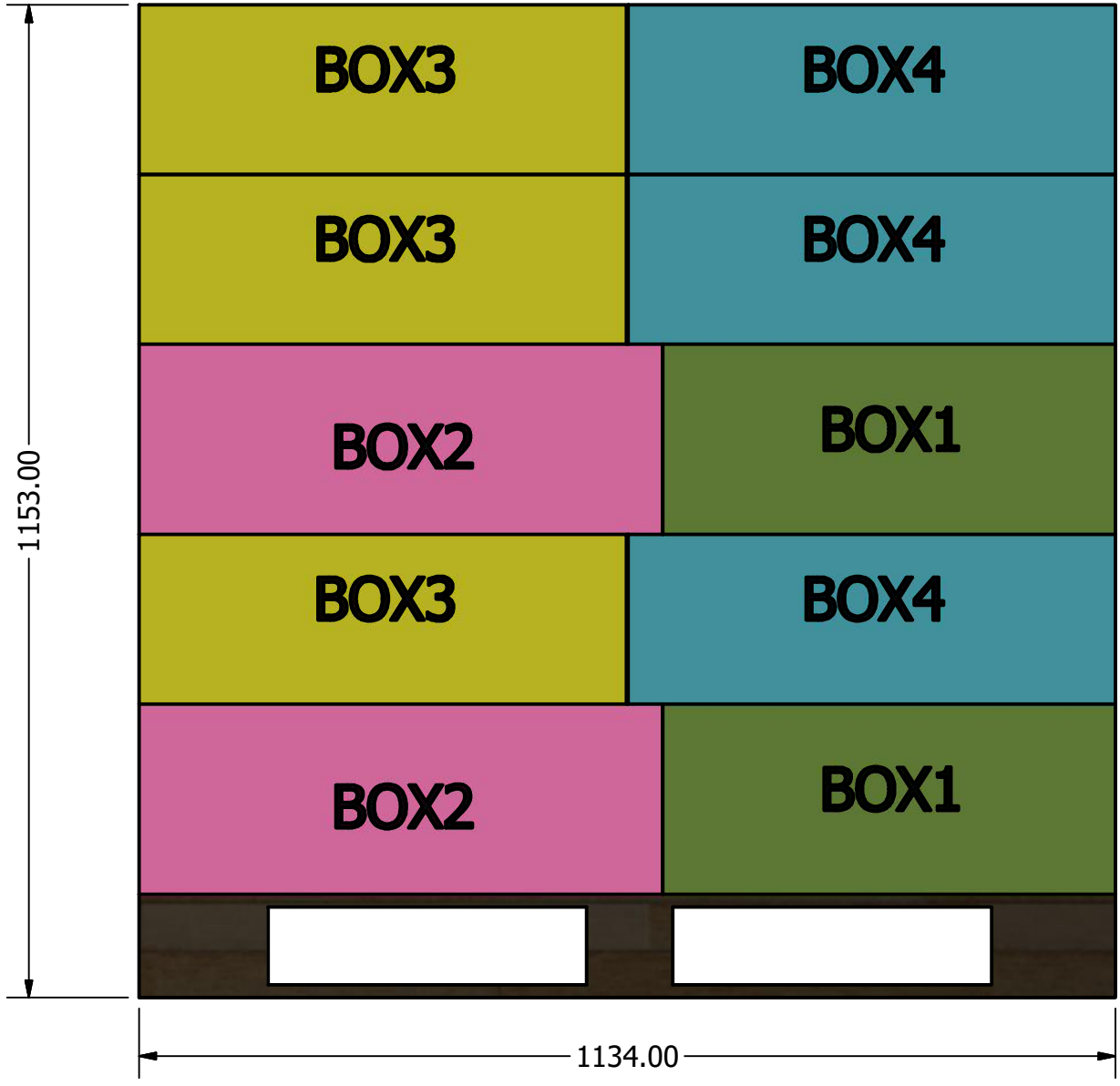
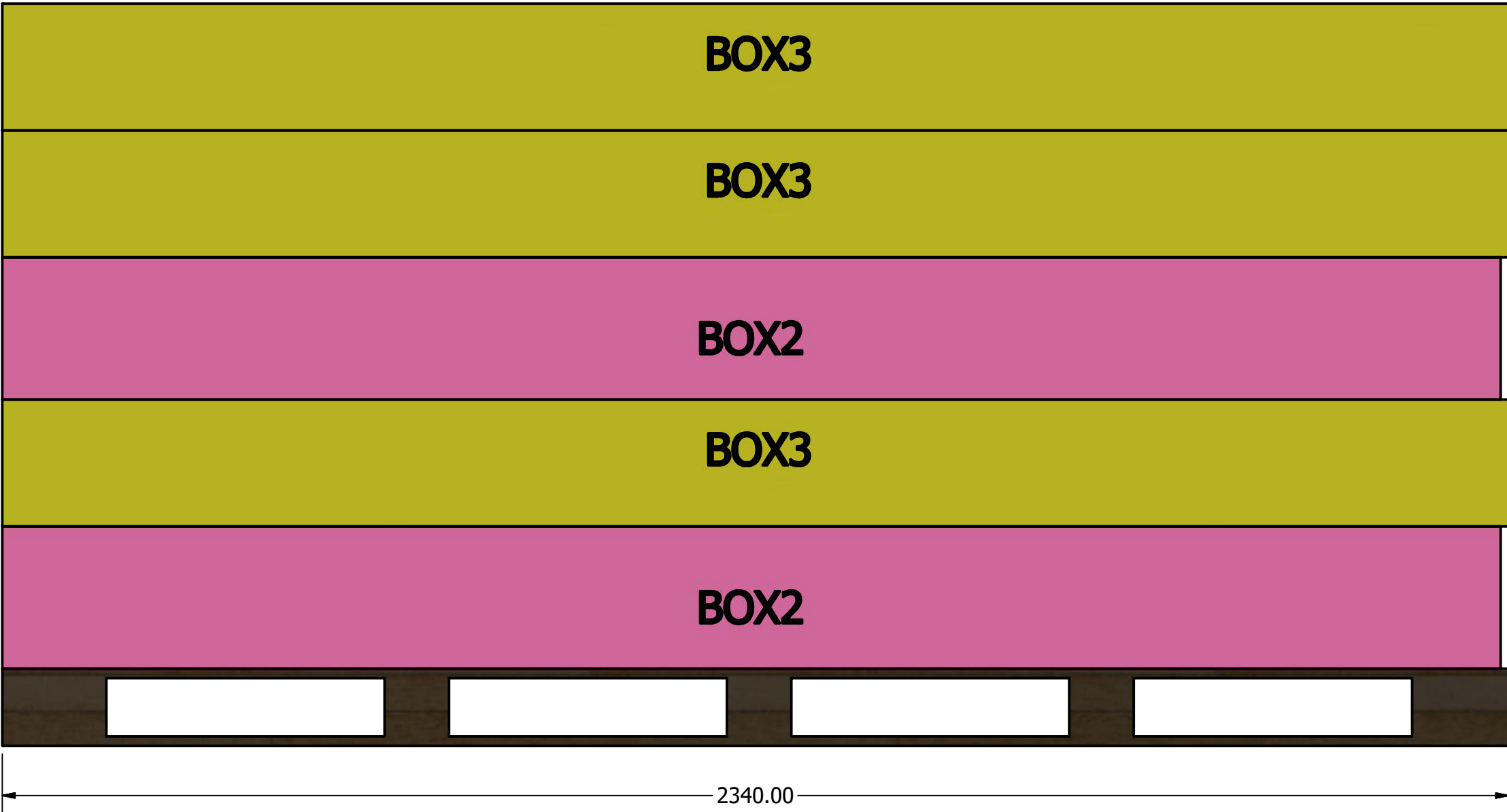
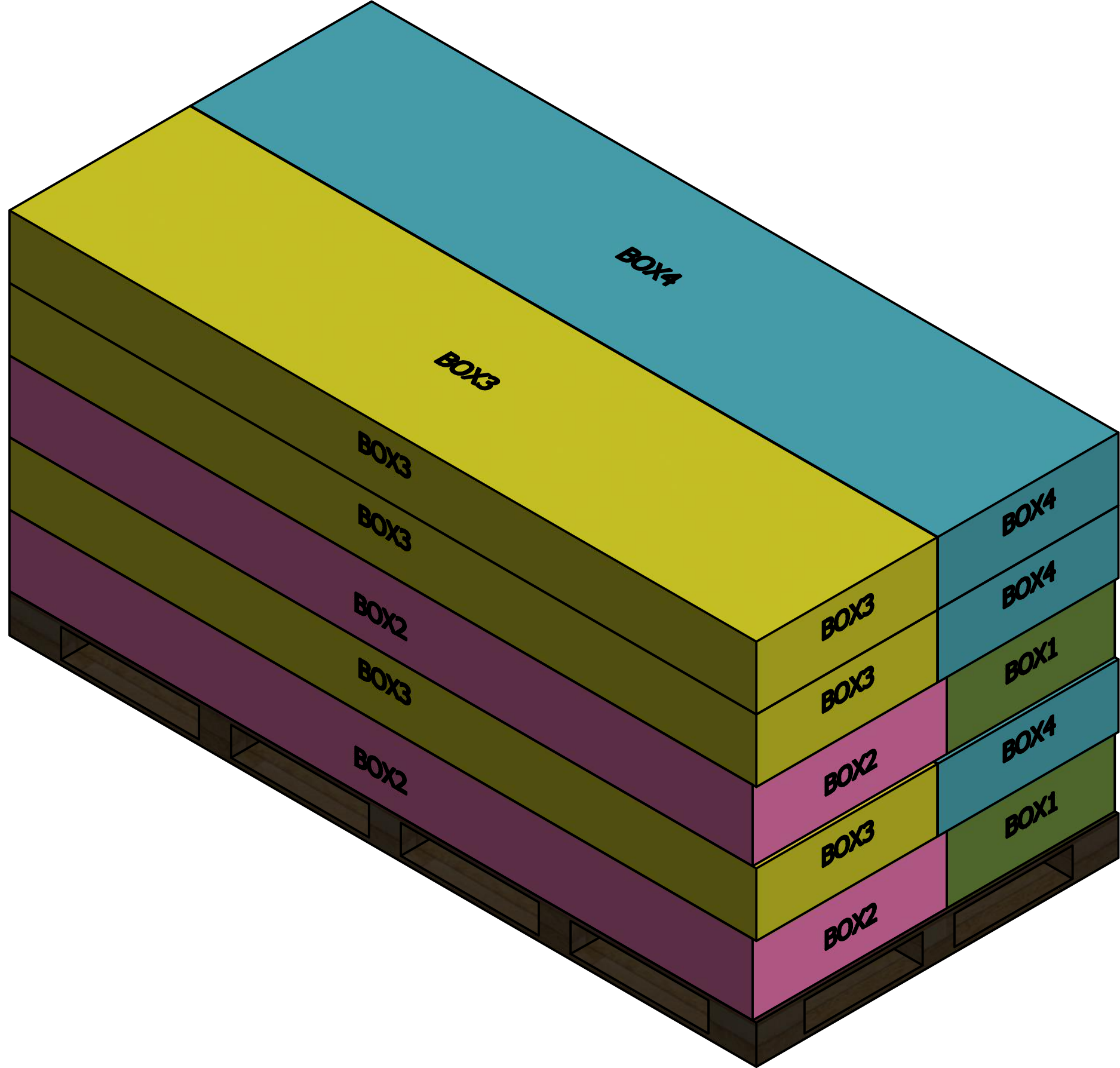
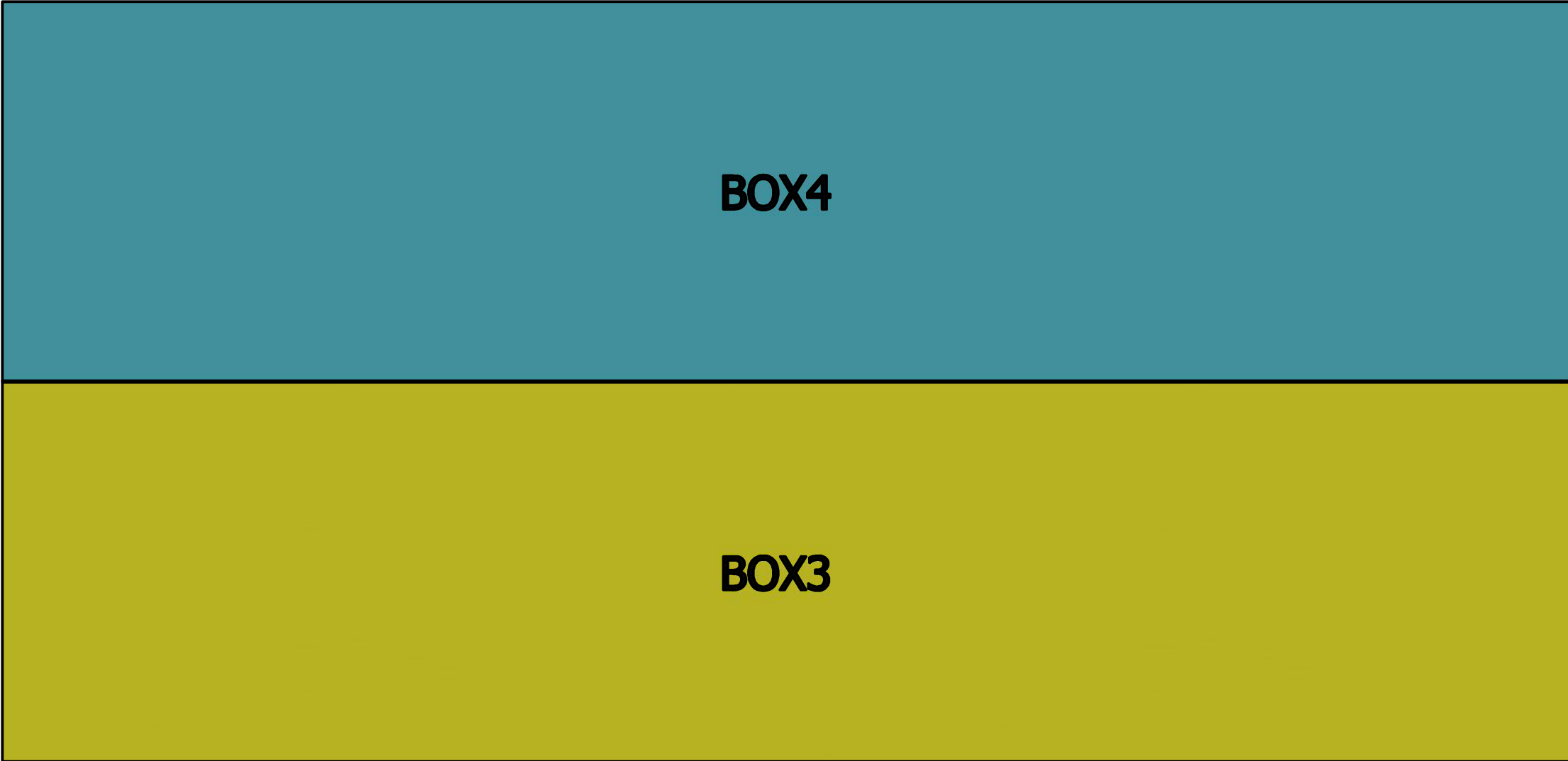

DRAWN Rudy	2019/8/19	TITLE		
CHECKED				
QA				
MFG				
APPROVED		SIZE D	DWG NO Pallet A	REV
		SCALE 1 / 8	SHEET 1 OF 1	

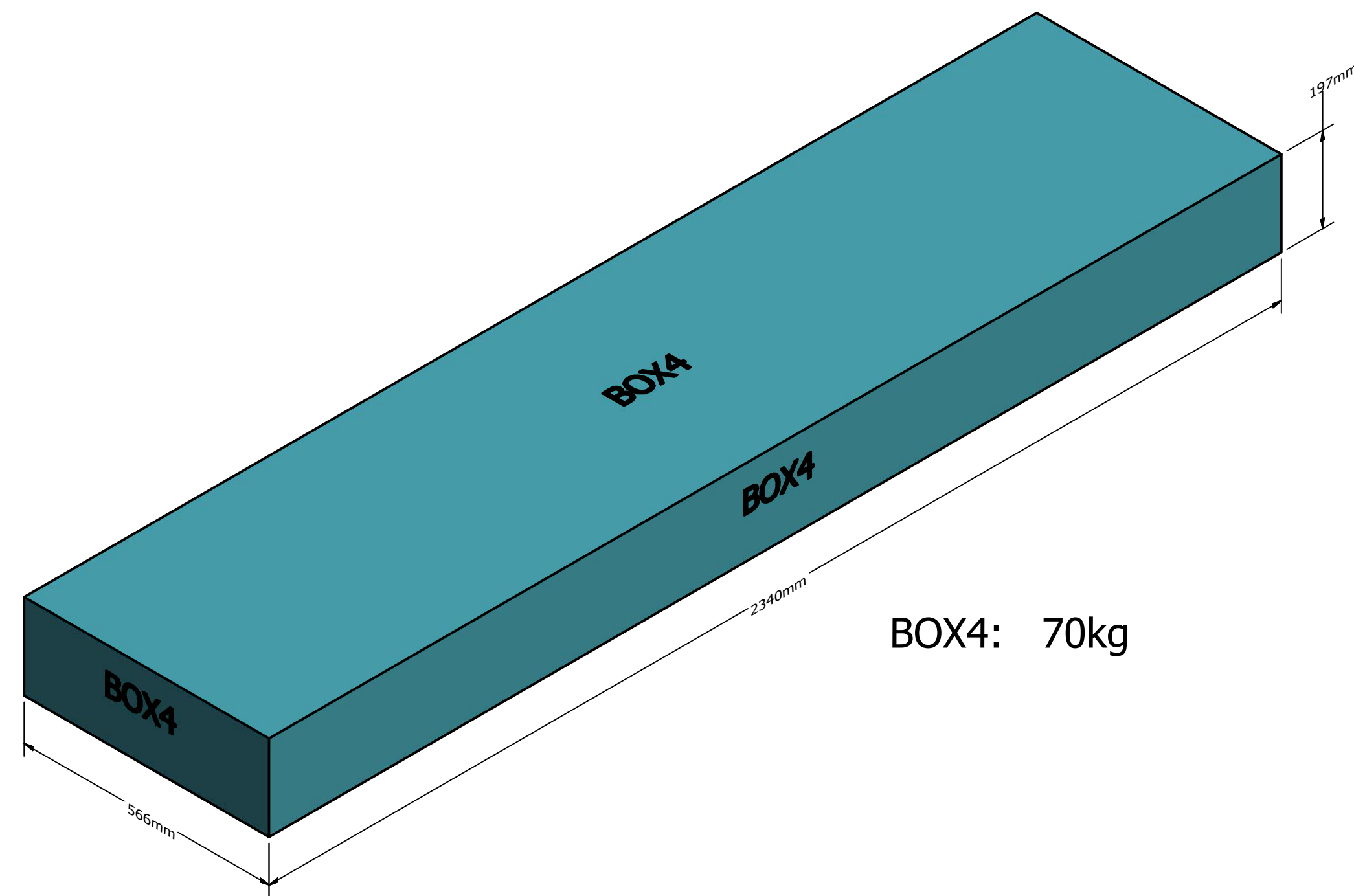
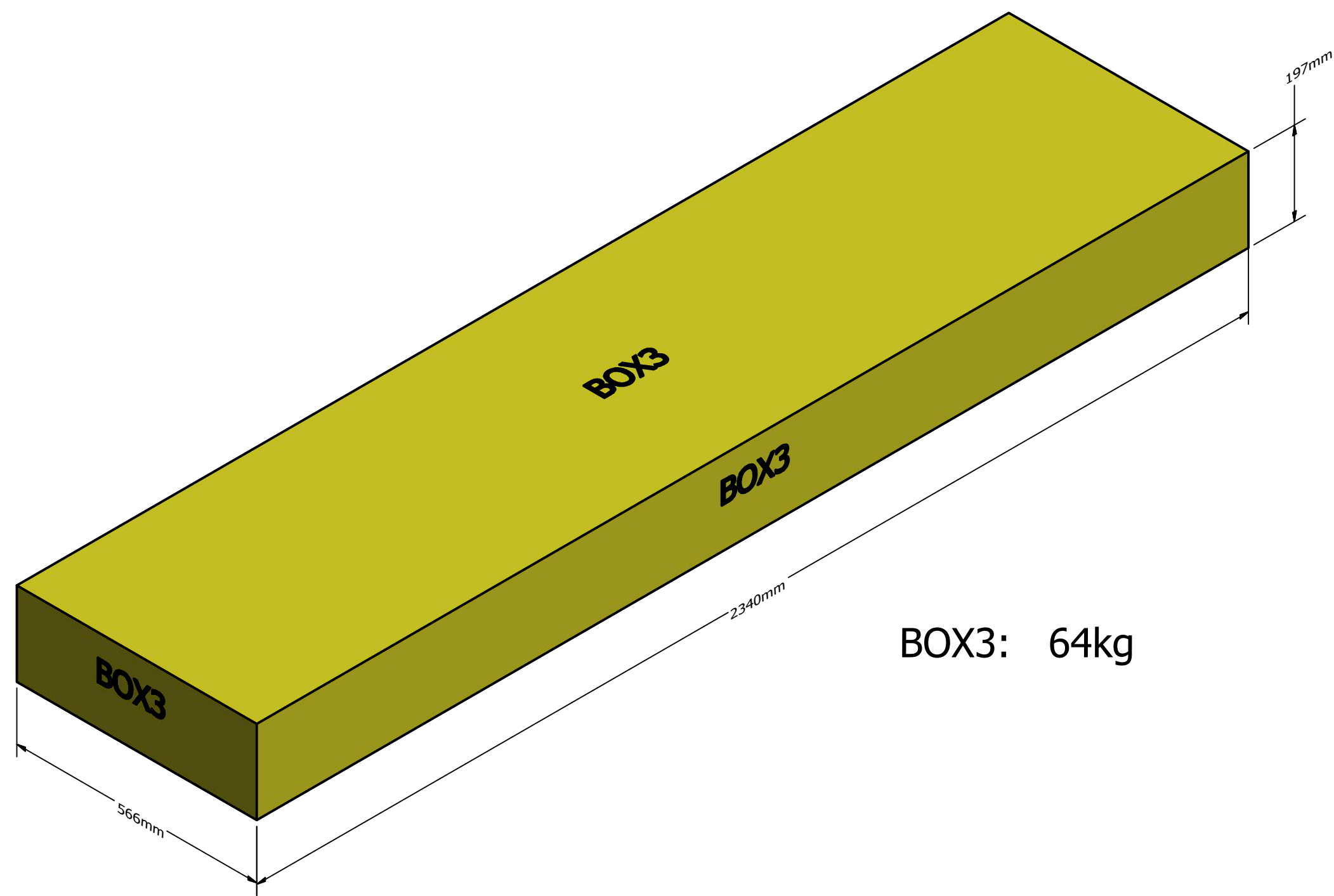
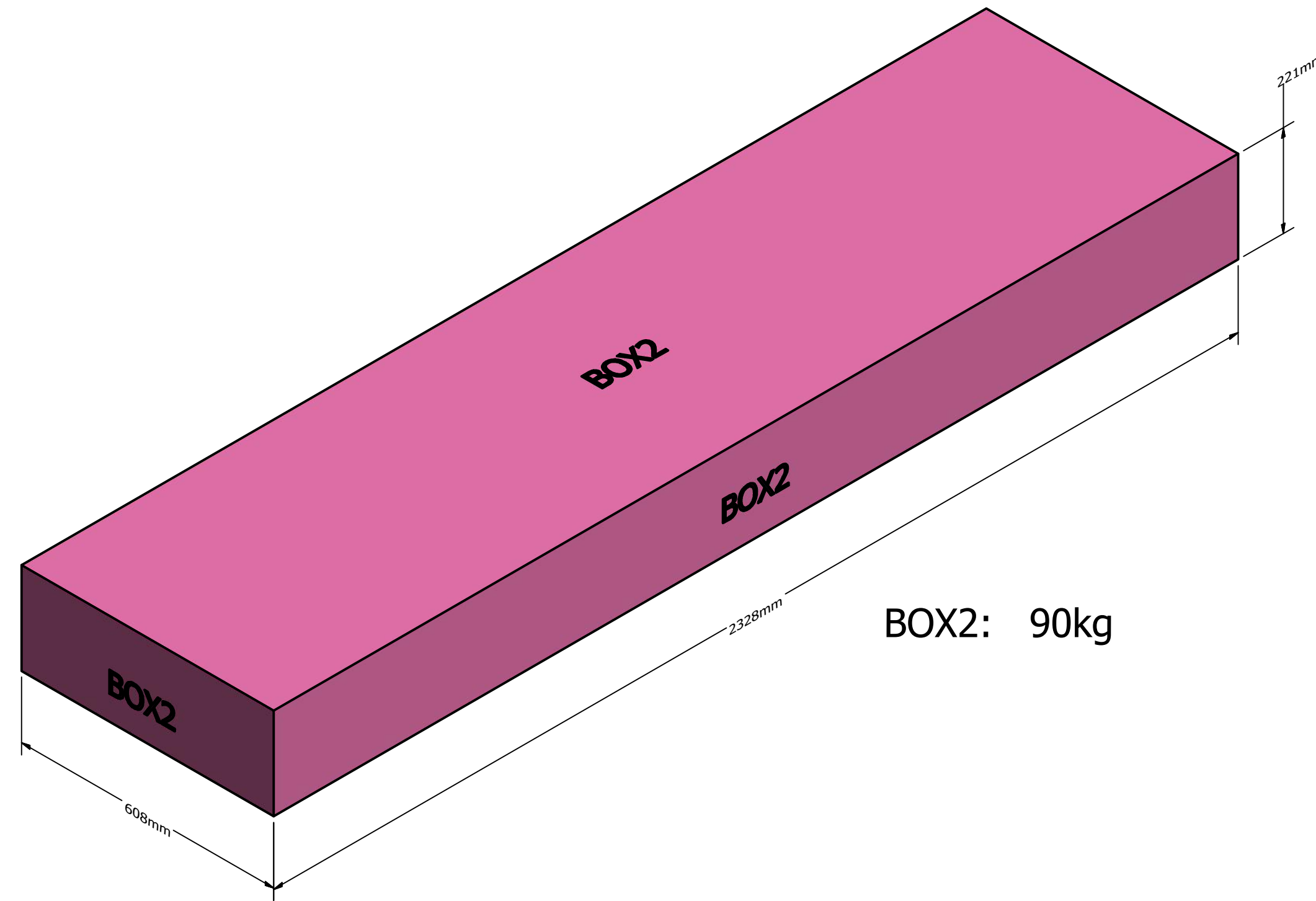
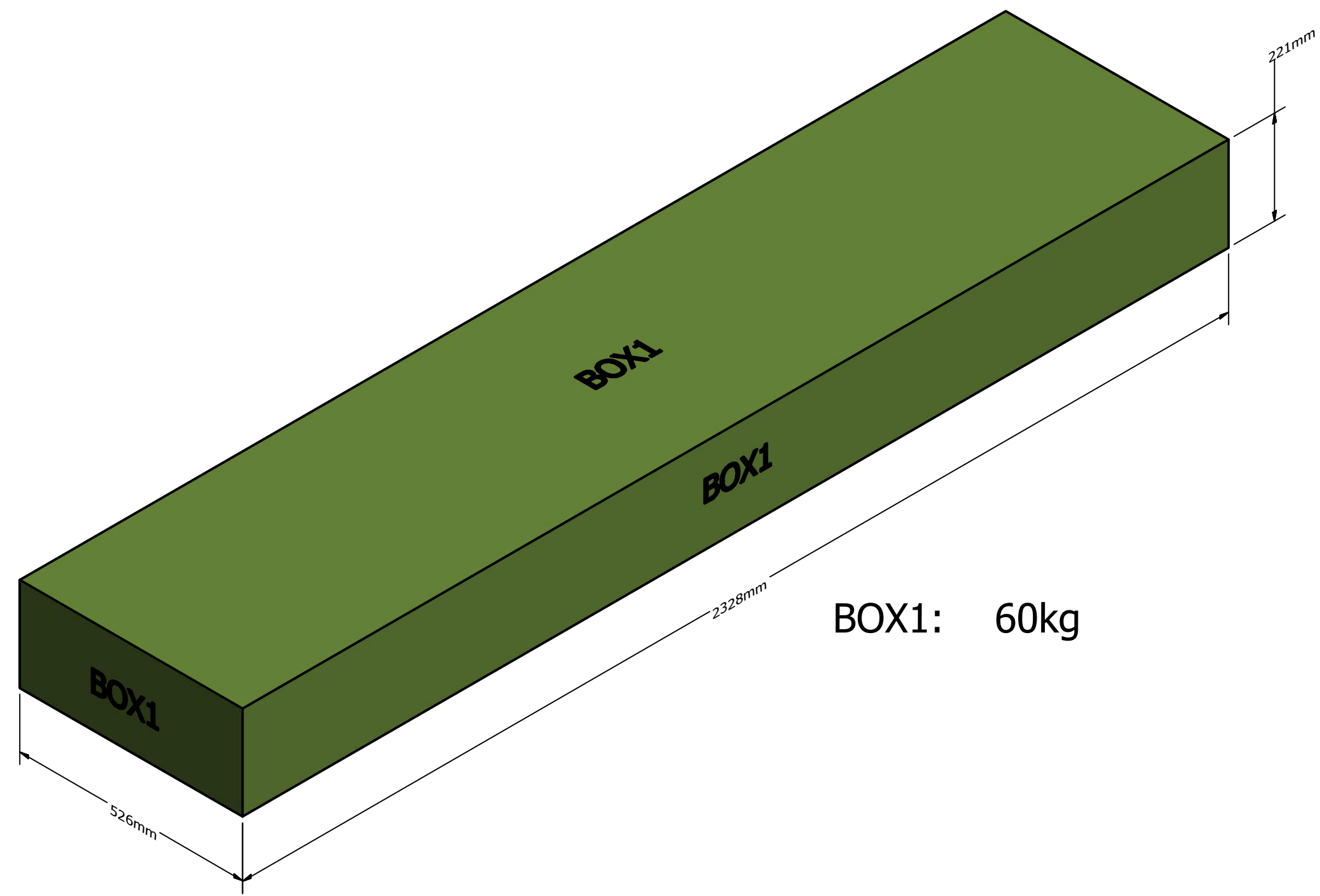

DRAWN	Rudy	2019/8/19		
CHECKED			TITLE	
QA				
MFG				
APPROVED				
			SIZE	DWG NO
			D	Pallet A (详细)
			SCALE	1 / 8
				SHEET 1 OF 1