

Please go to [www.quezel.com](http://www.quezel.com) for product cleaning tips. Go to the **Care + Maintenance** selection.

**Tools Required:** Flathead screwdriver, Phillips screwdriver, pliers, wire cutters, wire strippers, electrical tape, safety glasses.

**Light Source:** (3) Medium Base Type-A Bulbs (not supplied), Maximum 100W.

**Estimated Assembly Time:** 30-45 minutes

**Preparation:** Identify and inspect all parts before beginning installation. Check package content list and diagrams below to be sure all parts are present. If any parts are missing or damaged, do not attempt to assemble, install, or operate the fixture. Contact customer service for replacement parts.

### ⚠ Warnings and Cautions

Turn off electricity at circuit breaker or main fuse box before installation. Consult a licensed electrician if in doubt.

These instructions are provided for your safety. It is very important you read them completely before installing the fixture. We strongly recommend that a licensed, professional electrician perform the installation.

Disconnect fixture from power source before replacing bulbs. Make sure bulbs are given sufficient time to cool before removal. Do not subject glass parts to any shock while in operation or shattering may result.

### Package Contents

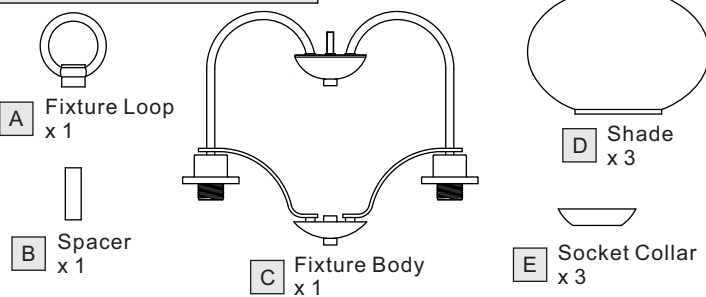

### Hardware Contents

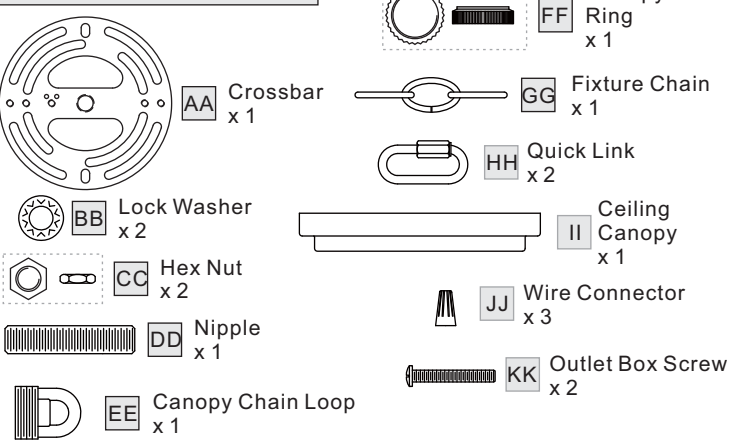

### STEP 1 – Install Crossbar

A. Attach the Crossbar (AA) to the Outlet Box with the head of the Green Ground Screw facing you. Secure it with Outlet Box Screws (KK). Tighten until snug.

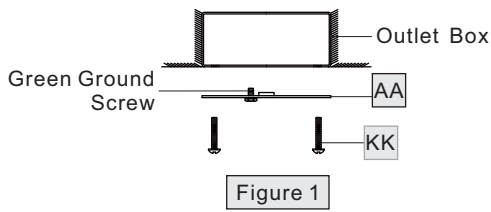

### STEP 2 – Install Canopy Chain Loop and Nipple

\* Pliers is required for this step.  
 A. Thread one Hex Nut (CC) to one end of the Nipple (DD) until it is at least 0.25" from the end. Pass one Lock Washer (BB) over the end of the Nipple (DD) and thread the Canopy Chain Loop (EE) onto the Nipple (DD). By using pliers, thread the Hex Nut (CC) against the Canopy Chain Loop (EE) and hand tighten until snug.  
 B. Thread another Hex Nut (CC) to the middle of the Nipple (DD). Place another Lock Washer (BB) over the Nipple (DD) and then thread the Nipple (DD) into the Crossbar (AA) until the Nipple (DD) is about 0.375" above the Crossbar (AA).  
 C. Remove the Canopy Lock Ring (FF) from the Canopy Chain Loop (EE). Place the Ceiling Canopy (II) over the Canopy Chain Loop (EE) against the ceiling to determine the correct position of the Nipple (DD). Thread the Canopy Lock Ring onto the Canopy Chain Loop (EE). Adjust the Nipple (DD) to allow the Ceiling Canopy (II) to rest against the ceiling when held in place by the Canopy Lock Ring (FF).  
 D. Remove the Canopy Lock Ring (FF) and the Ceiling Canopy (II). Tighten the Hex Nut (CC) against the Crossbar (AA) to secure in place.

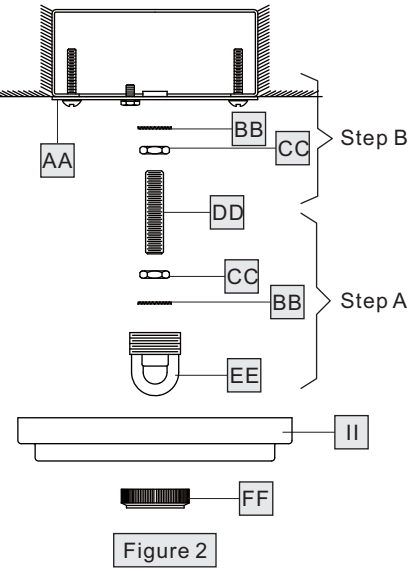

### STEP 3 – Assemble Fixture Loop

A. Pass the Spacer (B) over the nipple on the top center of the Fixture Body (C) and secure with the Fixture Loop (A). Hand tighten until snug.

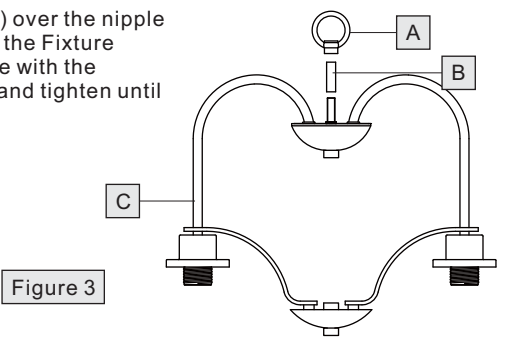

#### STEP 4 - Install Fixture Chain and Ceiling Canopy

- Adjust the Fixture Chain (GG) to your desired length by removing the links if needed.  
\* Pliers is required for this step.
- With the Fixture Chain (GG) not attached to the Fixture Loop (A) and the Canopy Chain Loop (EE), pull the supply wires through the Fixture Chain (GG) alternating links. After the wires are through the Fixture Chain (GG), pull the Supply Wires and the Ground Wire through the Canopy Lock Ring (FF) and the Ceiling Canopy (II) in order.
- Attach one end of the Fixture Chain (GG) to the Fixture Loop (A) with one Quick Link (HH). Lift the fixture and Fixture Chain (GG) up and attach the other end of the Fixture Chain (GG) onto the Canopy Chain Loop (EE) with another Quick Link (HH). The fixture will now hang safely. Close the chain loop at the Ceiling Canopy Loop (EE).
- Feed the Supply Wires and Ground Wire through the Canopy Chain Loop (EE) and Nipple (DD) into the Outlet Box. Cut the wires leaving approximately 8" of wire extending from the Outlet Box.
- Refer to Step 5 for wire connections.
- Raise the Ceiling Canopy (II) and Canopy Lock Ring (FF) up the Fixture Chain (GG) and over the Canopy Chain Loop (EE). Tighten the Canopy Lock Ring (FF) onto the Canopy Chain Loop (EE) until tight.

Suggested chain length for Ceiling height :

- 8' ceiling : use 14 links of chain
- 9' ceiling : use 23 links of chain
- 10' ceiling : use 32 links of chain

Figure 4

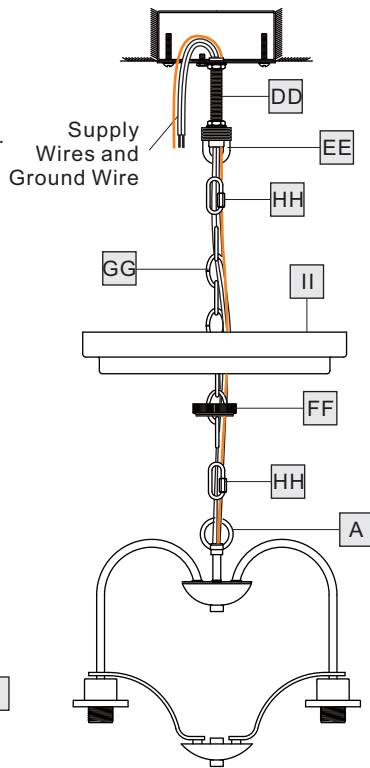

#### STEP 5 - Wire Connections

- Use standard wire connectors (JJ) to make all wire connections. Twist connectors until wires are tightly joined together. Wrap each connection with approved electrical tape and carefully stuff all the connected wires into outlet box.

Note: If the electrical wire is going to be cut shorter than provided you will need to identify the "L" line wire and the "N" neutral wire before you cut the excess wire off. One is labeled N and the other labeled L. To do this separate the "L" line wire and the "N" neutral wire as far as you need to. Re-label the wire near where you want to make the cut. Be sure to mark the wire on the side of the fixture and not on the excess wire being cut and removed.

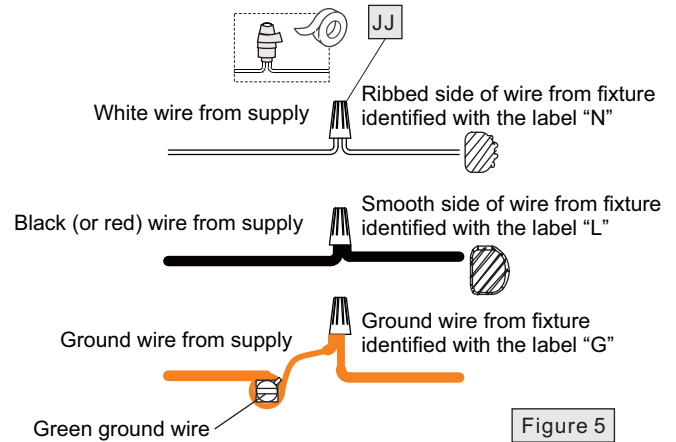

Figure 5

#### STEP 6 - Install Shade and Bulb

- Place the Shade (D) over the socket and secure with the Socket Collar (E). Hand tighten until snug.
- This fixture uses medium base Type-A bulbs (not supplied) with standard screw base. Maximum 100 watts. Insert bulb and screw snugly into place.

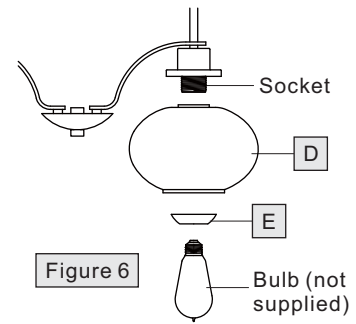

Figure 6

Your fixture is now assembled and ready to use. Enjoy!