

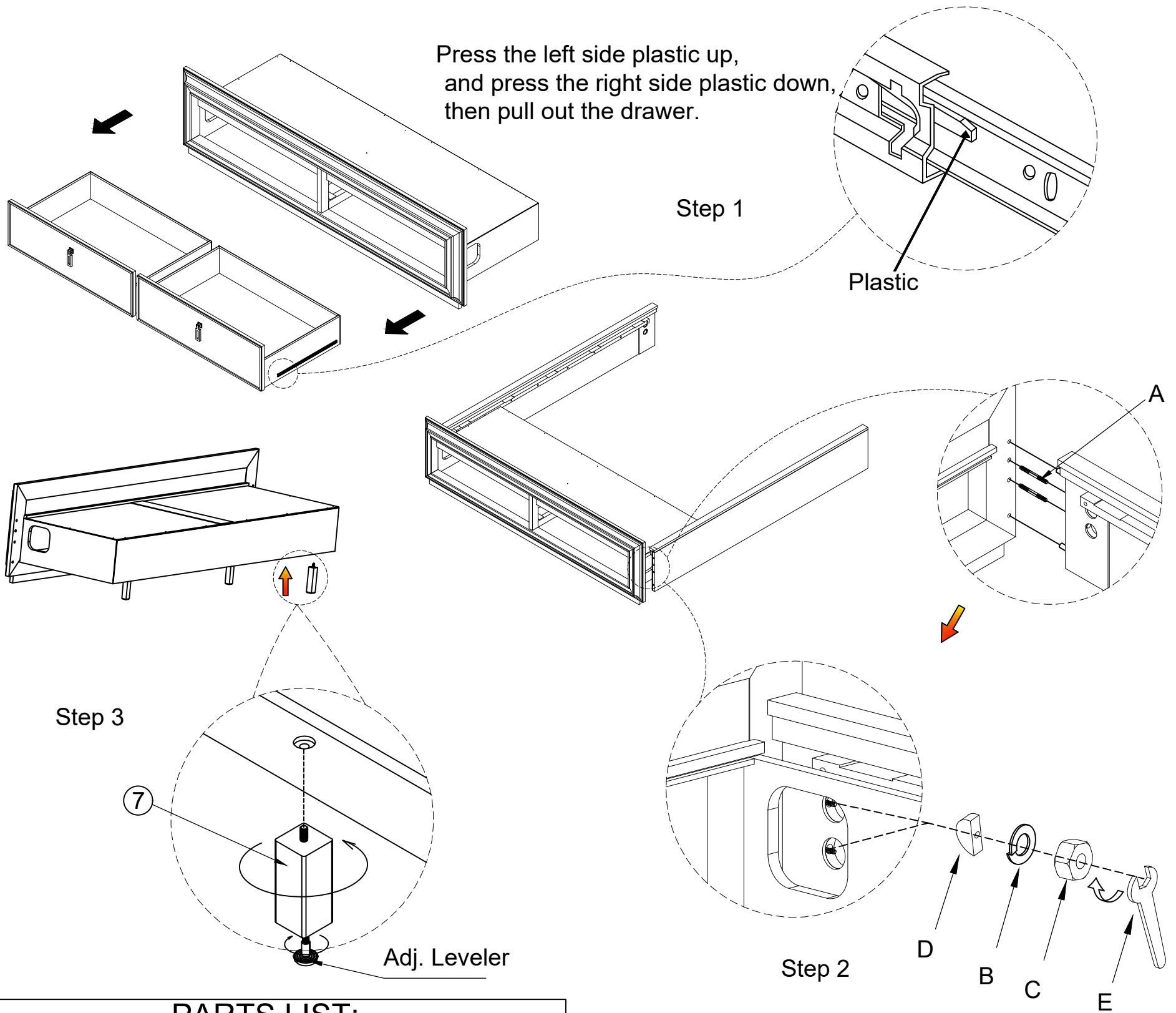







Thank you for purchasing this quality product from A.R.T. Furniture. Be sure to check all packing material for parts which may have come loose inside the carton during shipment. Identify and count all parts and compare with the parts list below.







Note: Some furniture is heavy, it is recommended that two people assembly this item to avoid injury or damage.



PARTS LIST:

No.	Description	Sketch	Q'ty
1	Headboard		1
2	Footboard		1
3	Bed rails		2
4	Wood slat		3
5	Wood slat		2
6	Slat support leg		3
7	Short support leg		3

HARDWARE LIST:

No.	Drawing	Description	Q'ty
A		$\frac{5}{16}$ " x4- $\frac{1}{2}$ " Threaded rod	8
B		$\frac{5}{16}$ " x \varnothing 12x3 Lock washer	8
C		$\frac{5}{16}$ " x12 Nut	8
D		L32x13x8 Curved washer	8
E		12mm Hex wrench	1
F		8#1" Screw	20

Thank you for purchasing this quality product from A.R.T. Furniture. Be sure to check all packing material for parts which may have come loose inside the carton during shipment. Identify and count all parts and compare with the parts list below.

Note: Some furniture is heavy, it is recommended that two people assembly this item to avoid injury or damage.

