

### Features

- A single handle controls both on/off activation and temperature setting
- Includes faceplate with handle
- Integrated push-button diverter
- Antiscald protection
- Coordinates with Components faucets, accessories, and showering components to complete your bathroom
- Pressure-balancing diaphragm technology maintains outlet temperature within +/-3°F during water pressure fluctuations

### Material

- Premium material construction with metal handle ensures reliability and durability
- KOHLER finishes resist corrosion and tarnishing

### Required Products/Accessories

K-11748 Series Rite-Temp® Valves

### Adapters, Rough-in and Extension Kits

1204798

Range: 3-5/8" (92 mm) -  
4-3/8" (111 mm)



### Codes/Standards

ASME A112.18.1/CSA B125.1

NOM Standards









NOM 012-CONAGUA

### KOHLER® Faucet Lifetime Limited Warranty

See website for detailed warranty information.

### Available Colors/Finishes

*Color tiles intended for reference only.*

Color	Code	Description
	CP	Polished Chrome
	SN	Vibrant® Polished Nickel
	AF	Vibrant® French Gold
	BN	Vibrant® Brushed Nickel
	BV	Vibrant® Brushed Bronze
	BL	Matte Black
	2MB	Vibrant® Brushed Moderne Brass
	TT	Vibrant Titanium
	BGP	Vibrant Brushed Graphite

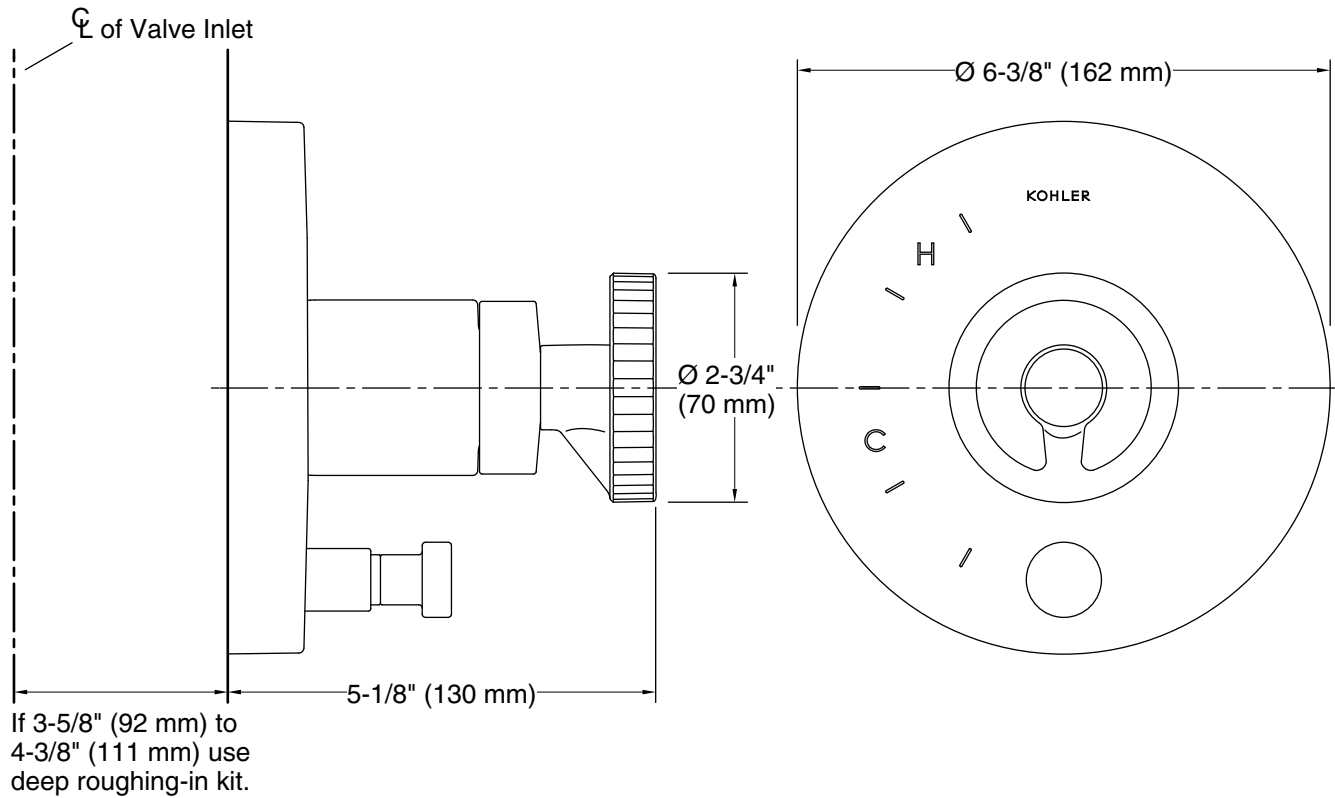

**Technical Information**

All product dimensions are nominal.

**Spout:**

**Notes**

Install this product according to the installation instructions.

Install straight pipe or tube drop of 7" (178 mm) to 18" (457 mm) with single elbow between the valve and the wall-mount spout.