







HEKMAN

ASSEMBLY INSTRUCTIONS

79310- Junior *Executive*

A HOWARD MILLER COMPANY

A		M8 * 35mm	2Pcs
B		5/16	2Pcs
C		5/16*19	2Pcs
D		5/16" * 4"	2 Pcs
E		4mm*80mm	1Pc
F		5mm*80mm	2Pcs
G		Key	4Pcs
H			4Pcs

Junior Executive

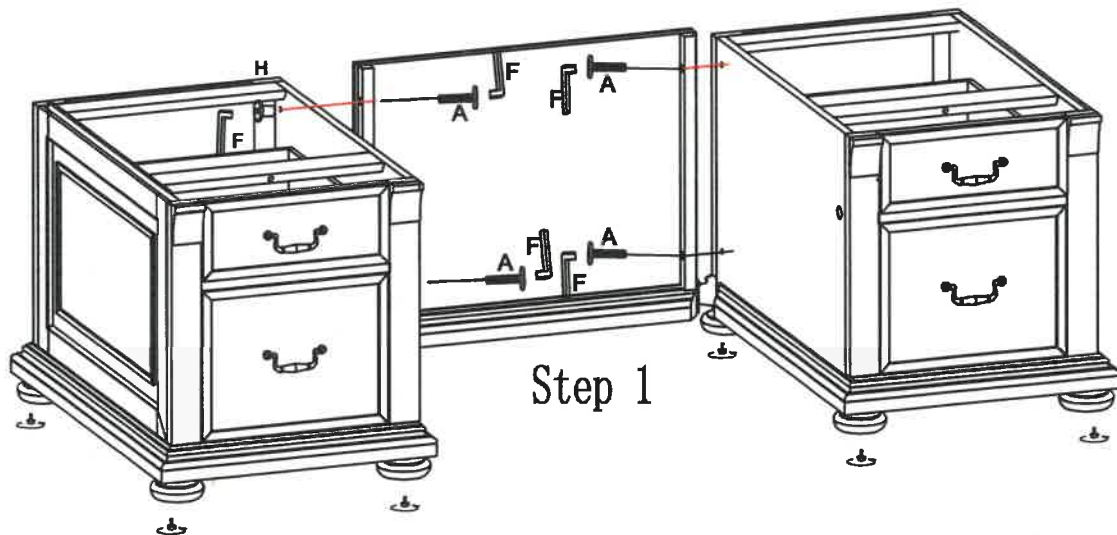
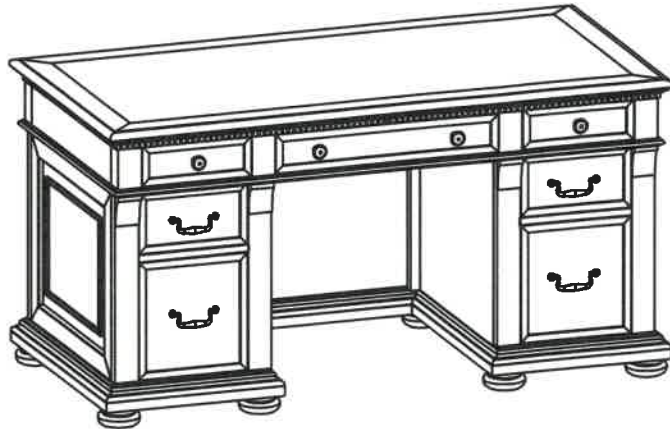

Step 1: Assemble the left and right bases and the center panel with Bolt (A), Lock Washer (B) and Washer (C) using wrench (F)

MADE IN VIETNAM

HEKMAN

A HOWARD MILLER COMPANY

ASSEMBLY INSTRUCTIONS

79310- Junior *Executive*

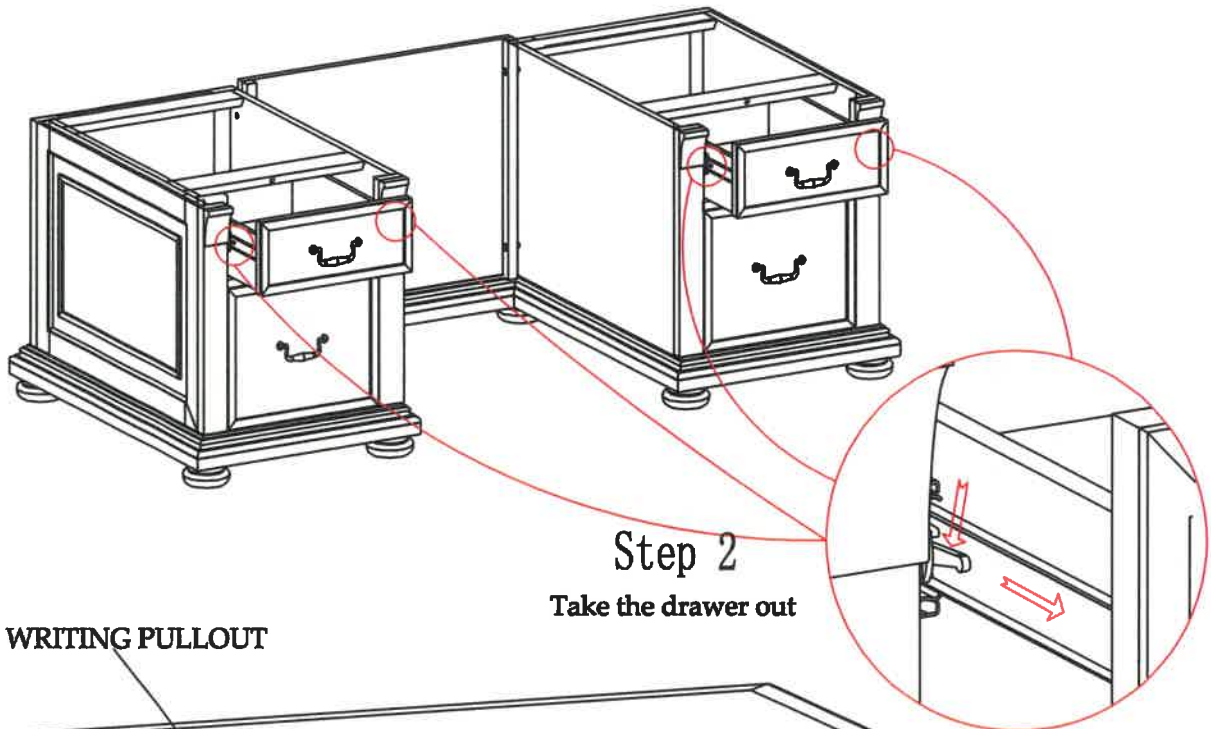

Step 2

Take the drawer out

WRITING PULLOUT

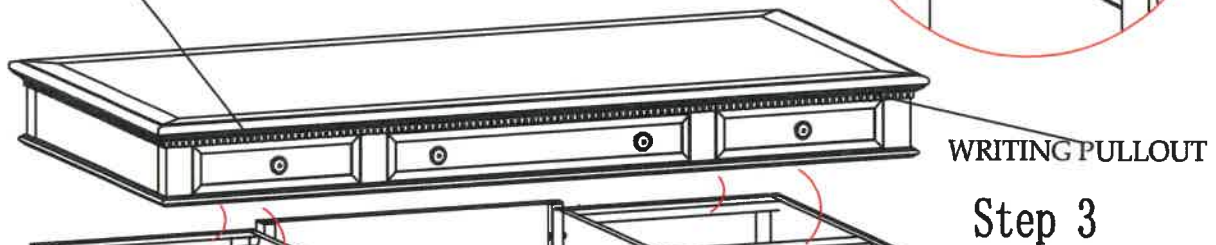

WRITING PULLOUT

Step 3

Step 2: Remove the upper drawers in both pedestals - Open drawer fully to expose the release levers in the center of the drawer slide. Push the lever on the left side up, and the lever on the right side down to release drawer. With levers pushed gently tug the drawer out of the desk

Step 3: Place the top assembly on the bases with Bolt (D), Lock Washer (B) and Washer (C) using wrench (E). Install and close the drawers after assembling.

MADE IN VIETNAM