



KA8

8" Touchpanel Controller

Reference Guide



KA8 Touchpanel

The KA8 touchpanel provides simple, intuitive control of the entertainment, environment and security systems in residential or commercial facilities. It features a fully customizable 8" widescreen LCD display with 1280x800 WXGA resolution and integrated capacitive touchscreen. The sleek touchpanel is easily wall mounted or an accessory stand is available for table top installations. The ambient light and proximity sensors automatically adjust the screen brightness and LED backlight according to the environmental light level. Built-in gigabit Ethernet with PoE enables powerful two-way control via the RTI control system, video from IP security cameras, and remote programming updates.

The KA8 provides superior quality and reliability as well as these features:

- 8" widescreen LCD with 1280x800 WXGA resolution and integrated capacitive touchscreen for fast touch response.
- Fully customizable display for simple, intuitive control.
- Innovative design allows wall mount or table top installation using stand accessory (sold separately).
- Ambient light and proximity sensor adjusts the screen brightness and LED backlights automatically according to the environmental light level.
- Powered by PoE (Power over Ethernet) or a power supply (sold separately).
- Gigabit Ethernet with PoE enables two-way control via the RTI control system, video from IP security cameras, and remote programming updates.

KA8 OVERVIEW

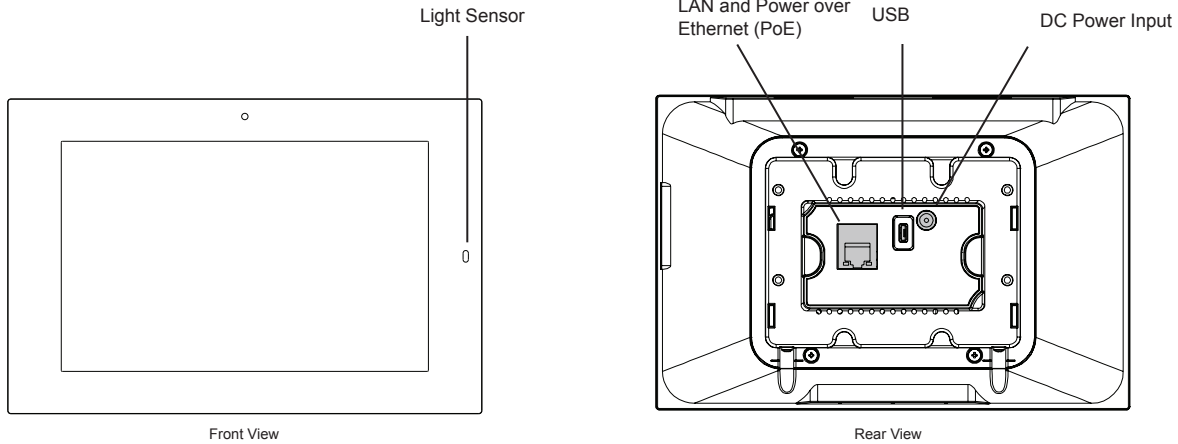

MOUNTING BRACKET INSTALLATION

The KA8 is designed to be wall mounted in either Portrait or Landscape orientation, or on tabletop using stand (available separately).

MOUNTING DEPTH

The KA8 requires a minimum mounting depth of 1"(2.45cm) from the wall surface to the room for cable/s.

MOUNTING HEIGHT

The recommended mounting height for the KA8 is 57"- 65"(145 cm -165 cm) from the finished floor to the center of the unit.

MOUNTING BRACKET

- The KA8 is designed to be mounted to a US standard 2 gang low voltage bracket like Arlington LV2 (included in the box).
- The KA8 mounting bracket, included in the box, should be attached to the 2 gang low voltage bracket with the supplied screws, then the KA8 unit is mounted on the mounting bracket with 2 captive screws located at the bottom.

Landscape/Portrait Mounting

- Landscape orientation: Install the 2 gang low-voltage bracket on a wall in its normal position.
- Portrait orientation: Install the 2 gang low-voltage bracket on wall after rotating it 90 degrees in a counterclockwise direction.

Installing the KA8 Mounting Bracket

- The KA8 package includes a mounting bracket that MUST be used for installation.
- Use the included screws to mount the bracket onto a two gang low-voltage bracket.
- Verify that the bracket is level before tightening the captive screws on the KA8.

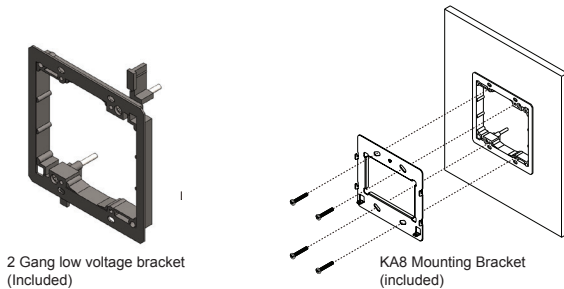

POWERING THE KA8

The KA8 is designed to be powered over an Ethernet connection with PoE or by connecting a 24v power supply (not included), but not both. If both the PoE and a 24v power supply are connected, the KA8 will draw power from the 24v source.

PoE Connection

- PoE connection requires IEEE 802.3at standard. Utilize a network switch or PoE injector that meets this standard.
- Connect the KA8 using a standard T568A or T568B Ethernet cable from the network switch to the LAN/PoE jack on the back of the KA8.

24v Power Supply

- You can provide power locally or remotely to KA8 by utilizing a 24VDC/1A power supply (not included).
- If powering remotely, ensure the wire is of adequate gauge for the length of the run and the routing is in compliance with local codes.
- Verify the polarity of the barrel connector on your power supply before connecting it to the KA8. The center pin of the KA8 Power Connector is positive and the outer ring is negative.
- Plug the connector into the DC jack on the back of the KA8.

POWERING UP THE KA8

- The KA8 will automatically power on when power is applied.

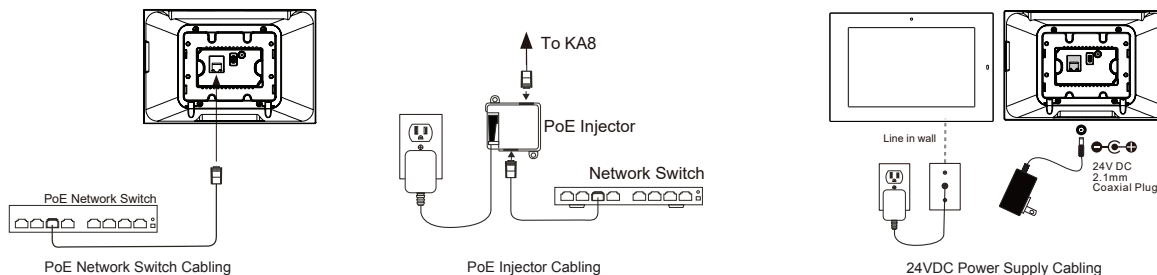

MOUNTING KA8

1. Loosen the captive screws of the unit to the level indicated by the lines in the diagram. Screws should not be removed from the unit.
2. Align the mounting frame hooks with the KA8 mounting slots and gently pull the KA8 unit down the mounting bracket. Make sure the mounting hooks are properly engaged.
3. To complete the installation, tighten the 2 captive screws on the bottom part of unit, to secure the KA8 on the mounting bracket.
4. For Portrait orientation, rotate mounting bracket and KA8 90 degree in counterclockwise direction before installation.

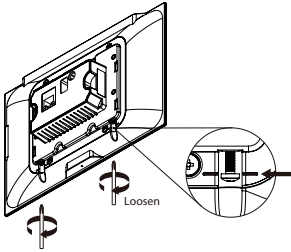

Loosen captive screws

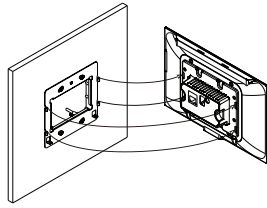

Align mounting frame hooks

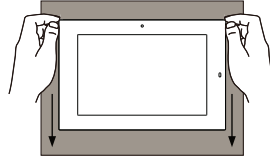

Gently pull KA8 down

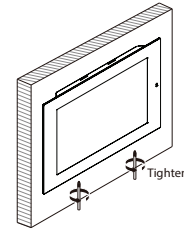

Tighten the 2 captive screws to secure the KA8 to the mounting bracket.

REMOVING THE KA8

- Using a Philips head screw driver, loosen the 2 captive screws on the KA8, then gently pull straight up from the mounting frame to disengage the unit.

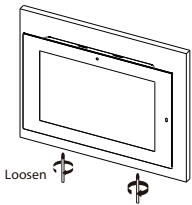

Loosen captive screws

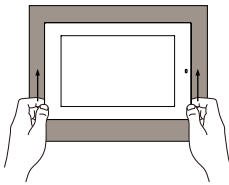

Gently pull KA8 up to release

DIMENSIONS

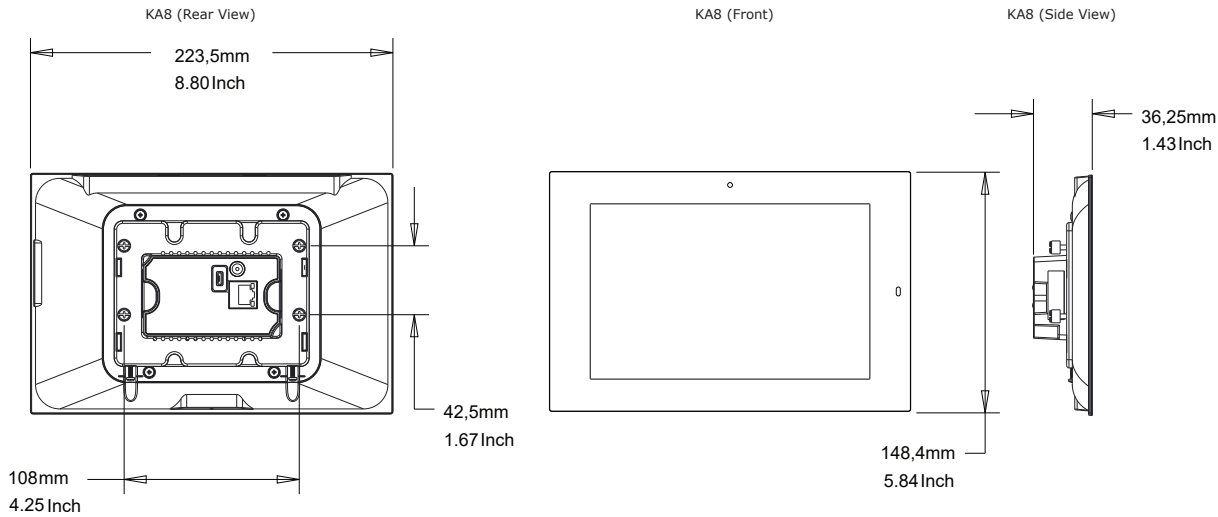

ETHERNET COMMUNICATION

- When the KA8 is connected to a network switch by Ethernet cable, the unit will acquire a network address via DHCP and automatically connect to the LAN.

PROGRAMMING

THE TOUCHSCREEN DISPLAY

- The KA8 touchscreen display is programmed using the RTI Integration Designer Programming Software. Normally it is organized into a series of pages containing objects (buttons, text, graphics, etc.) that are related to each other.

UPDATING SOFTWARE

- RTI's Integration Designer data files can be downloaded to the KA8 via an Ethernet network.

Product Contents

- One (1) KA8 Touchpanel
- One (1) Mounting Bracket
- Four (4) Mounting Screws
- One (1) 2 Gang Low Voltage Bracket
- One (1) Quick Reference Guide

Safety Suggestions

Read and Follow Instructions. Read all safety and operating instructions before operating the unit.

Retain Instructions. Keep the safety and operating instructions for future reference.

Heed Warnings. Adhere to all warnings on the unit and in the operating instructions.

Heat. Keep the unit away from heat sources such as radiators, heat registers, stoves, etc., including amplifiers that produce heat.

Power Sources. Connect the unit only to a power supply of the type described in the operating instructions, or as marked on the unit.

Power Cord Protection. Route power supply cords so that they are not likely to be walked on or pinched by items placed on or against them, paying particular attention to the cord plugs at power receptacles and at the point at which they exit from the unit.

Water and Moisture. Do not use the unit outdoors, in high humidity areas or near water—for example, near a sink, in a wet basement, near a swimming pool, near an open window, etc.

Object and Liquid Entry. Do not allow objects to fall or liquids to be spilled into the enclosure through openings.

Servicing. Do not attempt any service beyond that described in the operating instructions. Refer all other service needs to qualified service personnel.

Damage Requiring Service. The unit should be serviced by qualified service personnel when:

- The power supply cord or the plug has been damaged.
- Objects have fallen or liquid has been spilled into the unit.
- The unit has been exposed to rain.
- The unit does not appear to operate normally or exhibits a marked change in performance.
- The unit has been dropped or the enclosure has been damaged.

Cleaning

To clean your KA8, lightly dampen a lint-free cloth with plain water or a mild detergent and wipe the touchscreen, keypad and outer surfaces.

NOTE: Do not use harsh chemicals as damage to the unit may occur.

Federal Communications Commission Notice

This equipment has been tested and found to comply with the limits for a Class B digital device, pursuant to Part 15 of the FCC Rules. These limits are designed to provide reasonable protection against harmful interference in a residential installation. Any changes or modifications not expressly approved by the party responsible for compliance could void the user's authority to operate the device.

This equipment generates, uses, and can radiate radio frequency energy and, if not installed and used in accordance with the instructions, may cause harmful interference to radio communications. However, there is no guarantee that interference will not occur in a particular installation.

If this equipment does cause harmful interference to radio or television reception, which can be determined by turning the equipment off and on, the user is encouraged to try to correct the interference by one or more of the following measures:

- Reorient or relocate the receiving antenna.
- Increase the separation between the equipment and the receiver.
- Connect the equipment into an outlet on a circuit different from that to which the receiver is connected.
- Consult the dealer or an experienced radio/TV technician for help.

This device complies with Part 15 of the FCC Rules. Operation is subject to the following two conditions:

1. This device may not cause harmful interference.
2. This device must accept any interference received including interference that may cause undesired operation.

Industry Canada Compliance Statement

This device complies with Industry Canada license-exempt RSS standard(s). Operation is subject to the following two conditions:

1. This device may not cause harmful interference.
2. This device must accept any interference received including interference that may cause undesired operation.

Cet appareil est conforme avec Industrie Canada exempts de licence standard RSS (s). Son fonctionnement est soumis aux deux conditions suivantes:

1. Ce dispositif ne peut causer des interférences nuisibles.
2. Cet appareil doit accepter toute interférence reçue y compris des interférences qui peuvent provoquer un fonctionnement indésirable.



DECLARATION OF CONFORMITY (DOC)

The Declaration of Conformity for this product can be found on the RTI website at: www.rticorp.com/declaration

Contacting RTI

For news about the latest updates, new product information, and new accessories, please visit our web site at:

www.rticorp.com

For general information, you can contact RTI at:

Remote Technologies Incorporated

5775 12th Ave. E Suite 180

Shakopee, MN 55379

Tel. (952) 253-3100

Fax (952) 253-3131

info@rticorp.com

Service & Support

If you are encountering any problems or have a question about your RTI product, please contact RTI Technical Support for assistance (see the Contacting RTI section of this guide for contact details).

RTI provides technical support by telephone or e-mail. For the highest quality service, please have the following information ready:

- Your Name
- Company Name
- Telephone Number
- E-mail Address
- Product model and serial number (if applicable)

If you are having a problem with hardware, please note the equipment in your system, a description of the problem, and any troubleshooting you have already tried.

Please do not return products to RTI without return authorization.

Limited Warranty

RTI warrants its products for a period of three (3) years (90 days only for included battery packs); or for a period of time compliant with local laws when applicable from the date of purchase from RTI or an authorized RTI distributor.

This warranty may be enforced by the original purchaser and subsequent owners during the warranty period, so long as the original dated sales receipt or other proof of warranty coverage is presented when warranty service is required.

Except as specified below, this warranty covers all defects in material and workmanship in this product. The following are not covered by the warranty.

Damage resulting from:

1. Accident, misuse, abuse, or neglect.
2. Failure to follow instructions contained in this Guide.
3. Repair or attempted repair by anyone other than Remote Technologies Incorporated.
4. Failure to perform recommended periodic maintenance.
5. Causes other than product defects, including lack of skill, competence or experience of user.
6. Shipment of this product (claims must be made to the carrier).
7. Being altered or which the serial number has been defaced, modified or removed.