









Location:



**SLW-3612-1.5**  
**Two Handle Widespread Lavatory Faucet**  
**Specification Submittal**

| Model Numbers  | Feature Highlights  |
|--|---|
| <input type="checkbox"/> <b>SLW-3612-1.5</b> <i>Two Handle Widespread Lavatory Faucet</i>  | <ul style="list-style-type: none"> <li>• 8" to 16" mount configuration</li> <li>• Quarter turn ceramic cartridges</li> <li>• 1/2" IPS inlet connections</li> <li>• 6-5/8" height</li> <li>• Lift rod and metal drain assembly</li> <li>• Standard 1.5 gpm (5.7 L/min) flow rate</li> <li>• Faucet shall be metal construction, plated in standard polished chrome finish</li> </ul> |
| Finish Options/Modifications   | Compliance  |
| <input type="checkbox"/> <b>-0.5</b>  <i>0.5 gpm (1.9 L/min) flow restrictor</i><br><input type="checkbox"/> <b>-1.0</b>  <i>1.0 gpm (3.8 L/min) flow restrictor</i><br><input type="checkbox"/> <b>-H2</b>  <i>Alternative lever handle (Chrome and Satin Nickel only)</i><br><input type="checkbox"/> <b>-H3</b>  <i>Alternative lever handle (Chrome and Satin Nickel only)</i><br><input type="checkbox"/> <b>-BBZ</b> <i>Brushed Bronze finish</i><br><input type="checkbox"/> <b>-MB</b> <i>Matte Black finish</i><br><input type="checkbox"/> <b>-STN</b> <i>Satin Nickel finish</i> | <p>-ASME A112.18.1/CSA B125.1<br/>         -NSF/ANSI 61.9; NSF/ANSI 372<br/>         -WaterSense 1.5 gpm, 1.0 gpm</p>     |
| <p><b>Note:</b> Append appropriate -suffix to model number.</p>  | Warranty  |
|  | <p><b>Limited Lifetime</b> - to the original end purchaser in consumer/residential installations.<br/> <b>5 Years</b> - for industrial/commercial installations.<br/>         Refer to <a href="http://www.symmons.com/warranty">www.symmons.com/warranty</a> for complete warranty information.</p>  |

## Dimensions

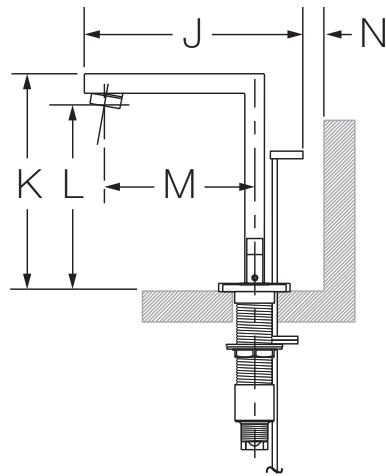
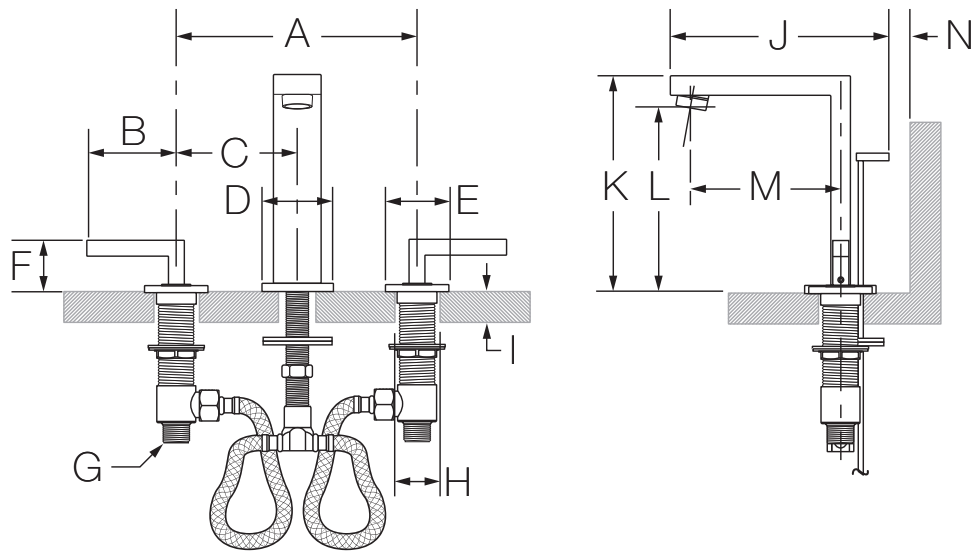

| Measurements |  |
|--------------|--|
| A            | Min. 8", 203 mm<br>Max. 16", 406 mm                            |
| B            | 2-3/4", 70 mm  |
| C            | 4", 102 mm   |
| D            | 2-1/8", 54 mm  |
| E            | 2", 51 mm  |
| F            | 1-5/8", 40 mm  |
| G            | 1/2-14 NPSM  |
| H            | (3x) Hole size<br>Min. Ø 1-1/4", 32 mm<br>Max. Ø 1-3/8", 35 mm |
| I            | Deck Thickness Ref.<br>Min. 7/8", 22 mm<br>Max. 2-3/8", 60 mm  |
| J            | 6-3/8", 161 mm   |
| K            | 6-5/8", 170 mm   |
| L            | 5-5/8", 143 mm   |
| M            | 4-5/8", 116 mm   |
| N            | Min. 1/2", 13 mm   |
| O            | 1-5/8", 41 mm  |
| P            | 2-3/4", 70 mm  |
| Q            | 1-3/4", 44 mm  |
| R            | 2-5/8", 67 mm  |

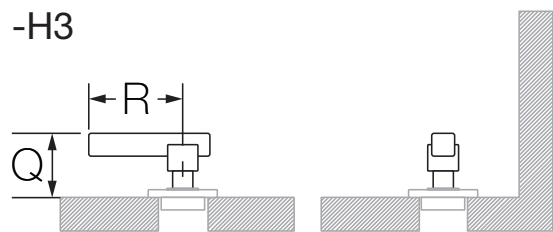
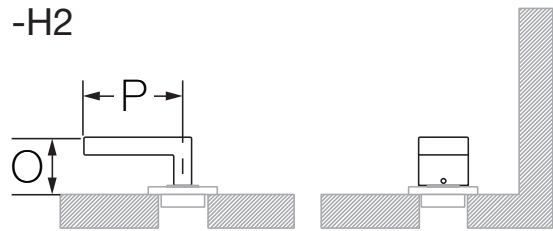

**Note:** Dimensions subject to change without notice.