

PRODUCT SPECIFICATIONS

Crosstown® 18 Gauge Stainless Steel 18-1/2" x 18-1/2" x 9" Single Bowl Undermount Sink Kit. Sink is handmade/fabricated from 18 gauge 304 Stainless Steel with a Polished Satin finish, Rear Center drain placement, and Full spray sides and bottom with Sides and Bottom pads.

Installation Type:	Sink Kits, Undermount
Material:	304 Stainless Steel
Finish:	Polished Satin
Gauge:	18
Sound Deadening:	Full spray sides and bottom with Sides and Bottom pads
Number of Bowls:	1
Sink Dimensions:	18-1/2" x 18-1/2" x 9"
Bowl 1 Dimensions:	17" x 17" x 9"
Drain Size:	3-1/2" (89mm)
Drain Location:	Rear Center
Minimum Cabinet Size:	24"
Mounting Hardware:	Part # 54300008 included
Template Included:	Yes
Cutout Template #:	1000001379

Template is available for download at [elkay.com](#). CAD software will be required to open the template.

Installation Profile:

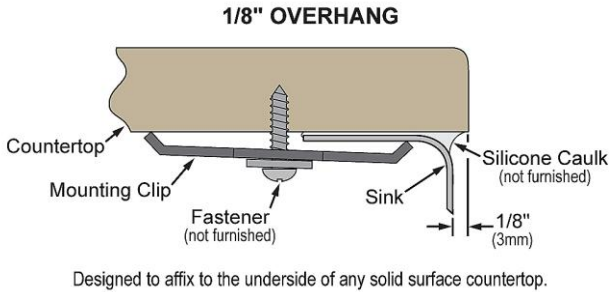

Included with Product: Custom fit bottom grid, deep strainer drain.

A Century of Tradition and Quality. For more than 100 years, Elkay has been making innovative products and providing exceptional customer care. We take pride in offering plumbing products that make life easier, inspire change and leave the world a better place.



Product Compliance: ASME A112.19.3/CSA B45.4
Accessory: ASME A112.18.2/CSA B125.2



Sinks are listed by IAPMO® as meeting the applicable requirements of the Uniform Plumbing Code®, International Plumbing Code®, and National Plumbing Code of Canada.

- [Clean and Care Manual \(PDF\)](#)
- [Clean and Care Manual \(PDF\)](#)
- [Installation Instructions \(PDF\) - 1000005239](#)
- [Installation Instructions \(PDF\) - 1000005235](#)
- [Warranty \(PDF\)](#)

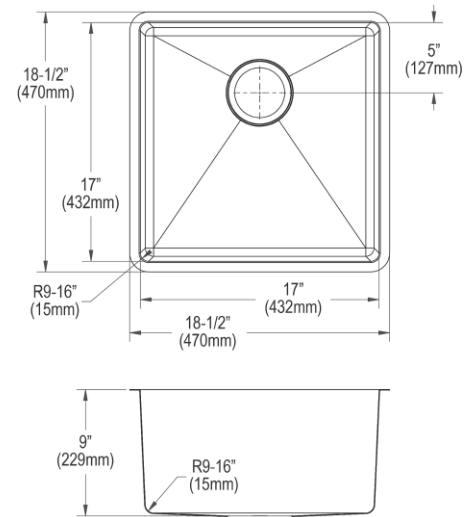

PART: _____ QTY: _____

PROJECT: _____







CONTACT: _____

DATE: _____

NOTES: _____

APPROVAL: _____

In keeping with our policy of continuing product improvement, Elkay reserves the right to change product specifications without notice. Please visit [elkay.com](#) for the most current version of Elkay product specification sheets. This specification describes an Elkay product with design, quality, and functional benefits to the user. When making a comparison of other producers' offerings, be certain these features are not overlooked. Latest version of the spec sheet available: https://www.elkayfiles.com/spec-sheets/ECTRU17179TC_spec.pdf

Included Accessories		
CTXBG1515	Crosstown® Stainless Steel 15-1/2" x 15-1/2" x 1-1/4" Bottom Grid Spec Sheet (PDF)	
LKDD	3-1/2" Drain Fitting Deep Strainer Basket Spec Sheet (PDF)	
Optional Accessories		
LKCBF17HW	Crosstown® Hardwood 18" x 9-3/4" x 3/4" Cutting Board Spec Sheet (PDF)	
LK3000CR	Everyday Kitchen Deck Mount Faucet with Remote Lever Handle Chrome Spec Sheet (PDF)	
LK3001CR	Everyday Kitchen Deck Mount Faucet with Remote Lever Handle and Side Spray Chrome Spec Sheet (PDF)	
LK5000	Everyday Single Hole Deck Mount Kitchen Faucet with Pull-out Spray Lever Handle + Optional Escutcheon Spec Sheet (PDF)	
LK6000	Everyday Single Hole Deck Mount Kitchen Faucet with Pull-down Spray Forward Only Lever Handle Spec Sheet (PDF)	

In keeping with our policy of continuing product improvement, Elkay reserves the right to change product specifications without notice. Please visit elkay.com for the most current version of Elkay product specification sheets. This specification describes an Elkay product with design, quality, and functional benefits to the user. When making a comparison of other producers' offerings, be certain these features are not overlooked. Latest version of the spec sheet available: https://www.elkayfiles.com/spec-sheets/ECTRU17179TC_spec.pdf