



bestchoiceproducts



INSTRUCTION MANUAL

3-Piece Cast Aluminum
Bistro Set

! NOTICE

Please retain these instructions for future reference.

- Do not stand on or use any part of this item as a step ladder.
- Firmly secure all bolts, screws and knobs before use.
- Reconfirm that all bolts, screws, and knobs are secure every 90 days.
- Be aware that some parts are heavy and have sharp edges.
- If any parts are missing, broken, damaged, or worn, stop using this product until repairs are made and/or factory replacement parts are installed.
- Do not use this item in a way inconsistent with the manufacturer's instructions as this could void the product warranty.

TOOLS REQUIRED



WRENCH
(PROVIDED)



143 LBS
TABLE
CAPACITY



220 LBS
CHAIR
CAPACITY



2 PERSON
ASSEMBLY



UP TO 45 MIN.
ASSEMBLY

HARDWARE

1

M8 x 25MM
STUD



6 PCS

2

M8 X 34MM
STUD



3 PCS

3

M8 WASHER



29 PCS

4

M8 SPRING
WASHER



29 PCS

5

M8 NUT



29 PCS

PARTS

A

TABLETOP



1 PC

B

TABLE LEG

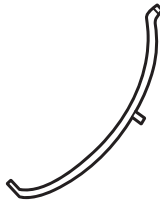

3 PCS

C

LEG SUPPORT



1 PC

D

CHAIR BACKREST



2 PCS

E

CHAIR SEAT

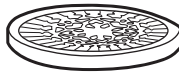

2 PCS

F

CHAIR LEG

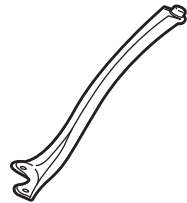

8 PCS

PRODUCT ASSEMBLY - TABLE

1

Attach three part B table legs to part A tabletop with six part 1 studs, six part 3 washers, six part 4 spring washers, and six part 5 nuts.

NOTE: Fasten hardware loosely during initial assembly. Do not firmly tighten hardware until item is completely assembled.

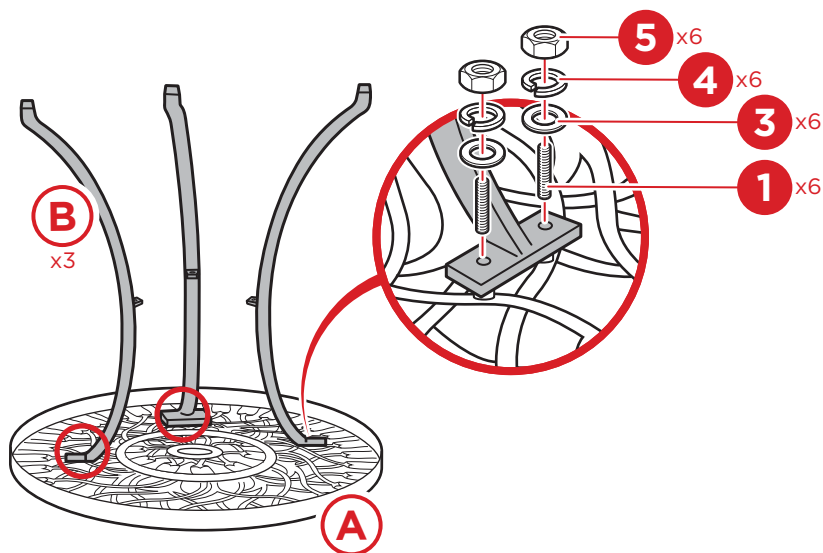

2

Attach part C leg support to the table legs with three part 2 studs, three part 3 washers, three part 4 spring washers, and three part 5 nuts.

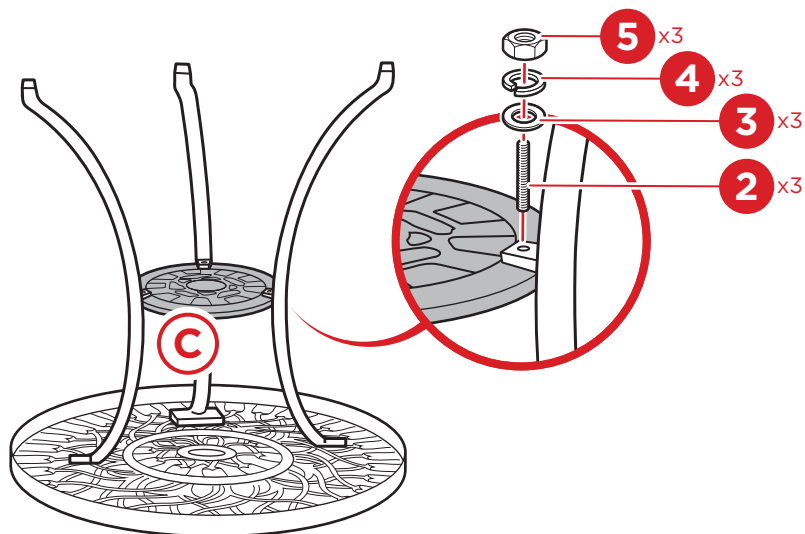

PRODUCT ASSEMBLY - TABLE

3

Flip the table upright. Adjust the screw-on feet until the table is level with the ground.

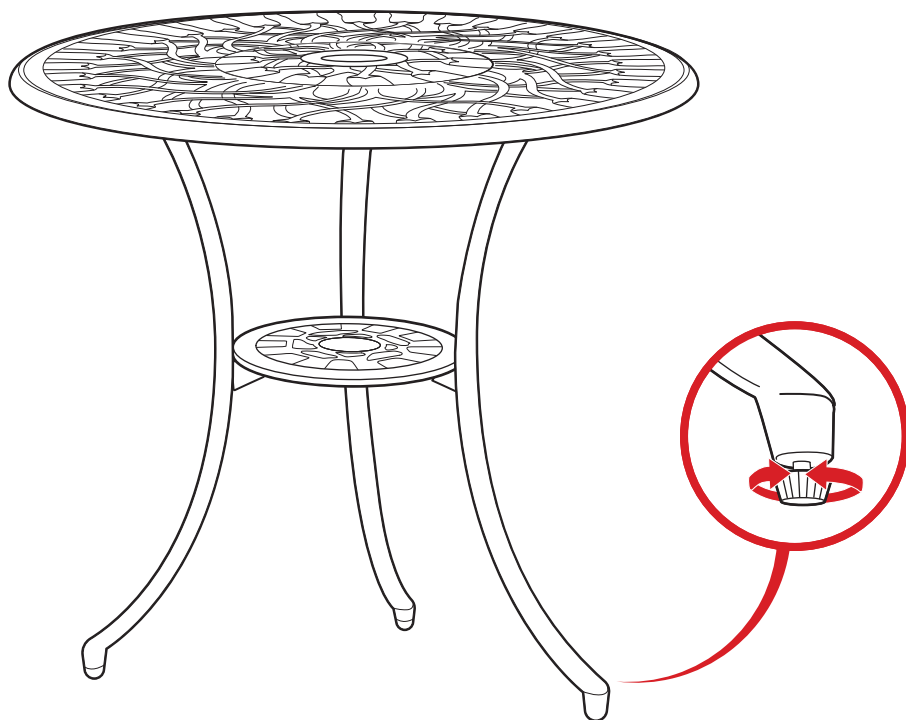

PRODUCT ASSEMBLY - CHAIR

1

Insert the two studs on the part D backrest into the holes in the part E seat. Secure the backrest with two part 3 washers, two part 4 spring washers, and two part 5 nuts.

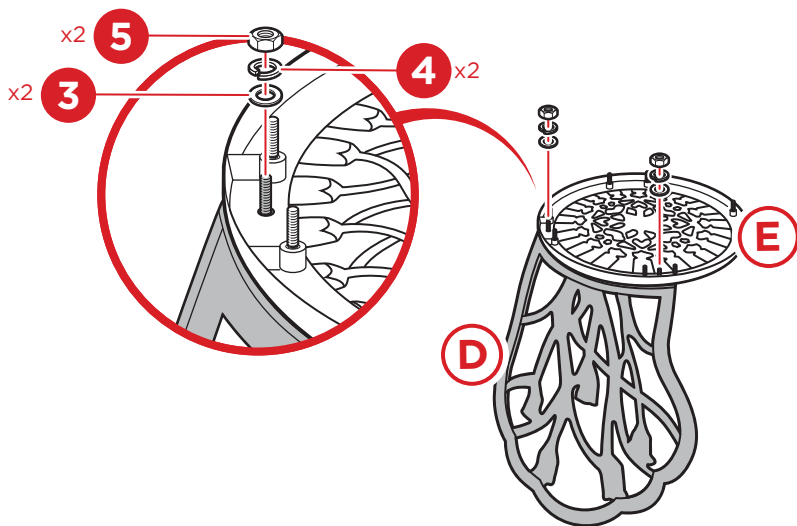

2

Attach four part F chair legs to the seat with eight part 3 washers, eight part 4 spring washers, and eight part 5 nuts.

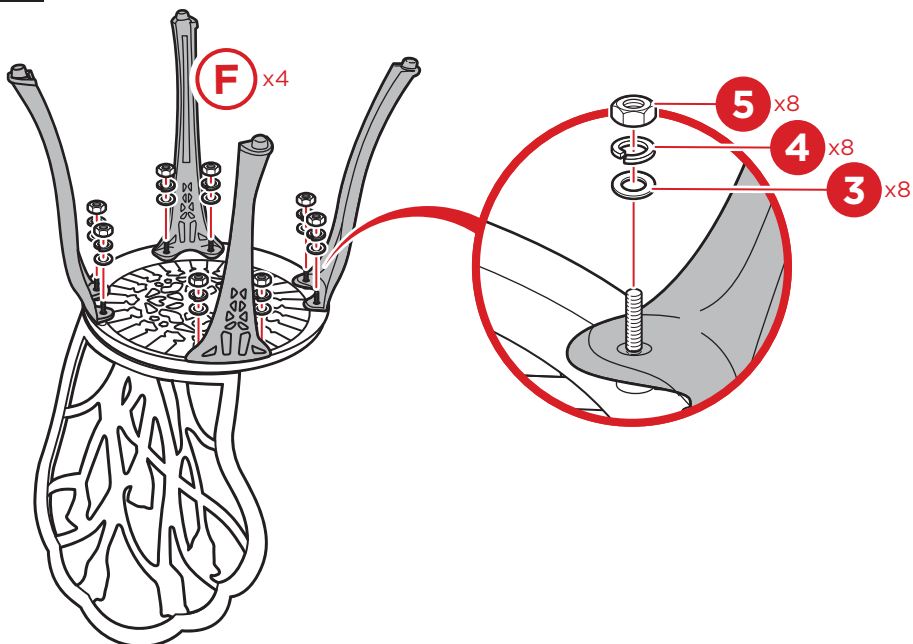

PRODUCT ASSEMBLY - CHAIR

3

Adjust the screw-on feet until the chair is level with the ground.
Repeat steps to build a second chair.

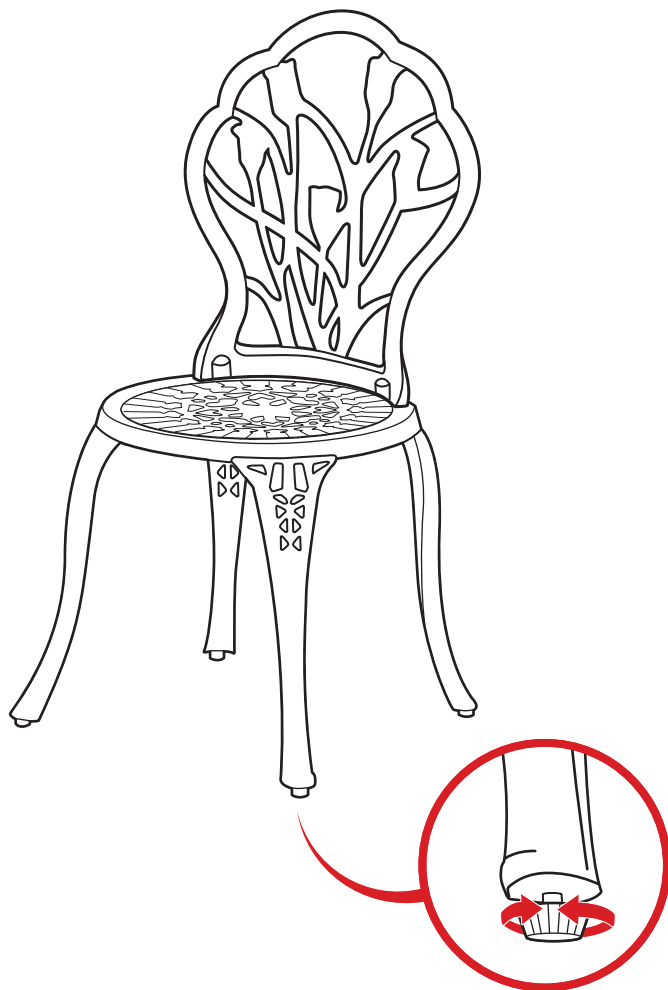



HELP CENTER



Question about your product? We're here to help. Visit us at:

help.bestchoiceproducts.com



Product Assembly



Returns & Refunds

PRODUCT WARRANTY INFORMATION

All items can be returned for any reason within 60 days of the receipt and will receive a full refund as long as the item is returned in its original product packaging and all accessories from its original shipment are included. All returned items will receive a full refund back to the original payment method. All returned items will not be charged a re-stocking fee.

All returned items require an RA (Return Authorization) number, which can only be provided by a Best Choice Products Customer Service Representative when the return request is submitted. Items received without an RA may not be accepted or may increase your return processing time. Once an item has been received by Best Choice Products, refunds or replacements will be processed within 5 business days.

All returns must be shipped back to the Best Choice Products Return Center at the customer's expense. If the reason for return is a result of an error by Best Choice Products then Best Choice Products will provide a pre-paid shipping label via email. Boxes for return shipping will not be provided by Best Choice Products, and is the customer's responsibility to either use the original shipping boxes or purchase new boxes.

Pictures may be required for some returns to ensure an item is not damaged prior to its return. Items returned are not considered undamaged until they are received by Best Choice Products and verified as such. All damages to items are the customer's responsibility until the item has been received by and acknowledge by Best Choice Products as undamaged.

WARNING

Manufacturer and seller expressly disclaim any and all liability for personal injury, property damage or loss, whether direct, indirect, or incidental, resulting from the incorrect attachment, improper use, inadequate maintenance, unapproved modification, or neglect of this product.