



Project Name _____

Date _____ Type _____

Notes _____

APPLICATIONS

Lighting installations for side and top mounting of luminaires with effective projected area (EPA) not exceeding maximum allowable loading of the specified pole in its installed geographic location.

CONSTRUCTION

Shaft:	One-piece tapered aluminum with round cross section, made of 6061-T6 shaft and 356-T6 cast aluminum base
Base Cover:	Two-piece square aluminum base cover included standard
GROUP 1	
Anchor Bolts:	Supplied with (3) galvanized anchor bolts with minimum yield of 55,000 psi (ASTM F1554). Galvanized hardware with two washers and two nuts per bolt for leveling. Top nut is acorn nut
Pole Cap:	3" pole top standard; Supplied with removable cover when applicable; Tenon configurations also available
Hand Hole:	2" X 4" handhole opening with cover grounding provision provided opposite handhole opening. The handhole is located 18" from the base of the pole.
GROUP 2	
Anchor Bolts:	Supplied with (4) galvanized anchor bolts with minimum yield of 55,000 psi (ASTM F1554). Galvanized hardware with two washers and two nuts per bolt for leveling
Bolt Cover:	Four individual bolt covers provided
Pole Cap:	Pole shaft supplied with removable cover when applicable; Tenon and post-top configurations also available
Hand Hole:	4" X 6" handhole opening with cover and grounding provision handhole 3" x 5" for 20' pole. The handhole is located 18" from the base of the pole.

FINISH

- Durable thermoset polyester powder coat paint finish with nominal 3.0 mil thickness
- Decorative finish coat available in three standard colors; Custom colors available; RAL number preferable

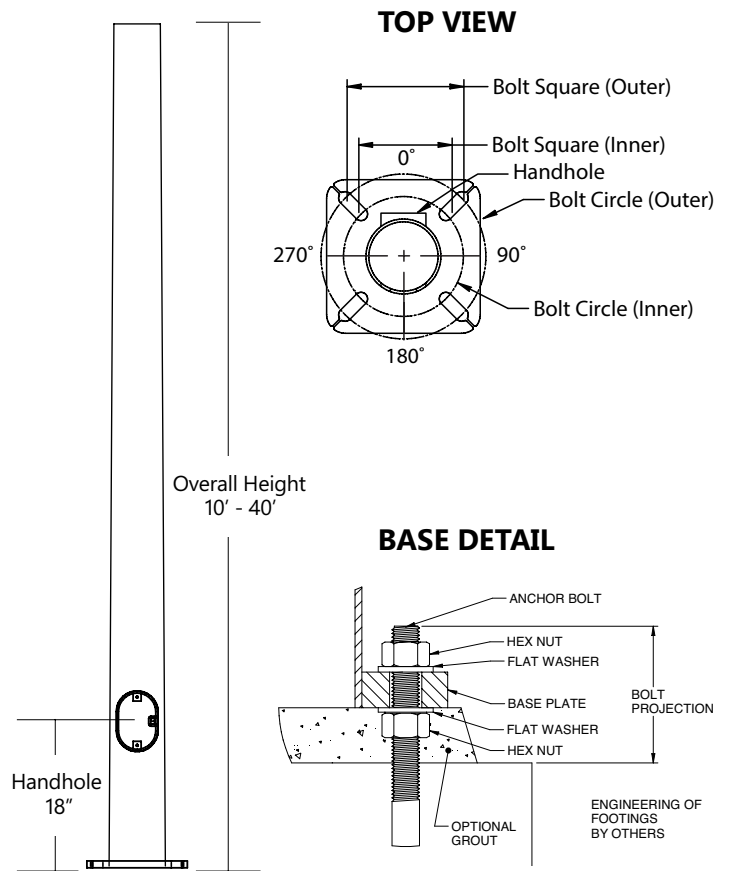

POLE CAP

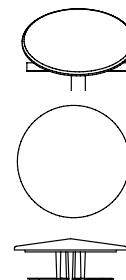

TENON

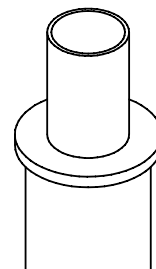

RTAE Series Poles

Round | Tapered | Aluminum

Ordering Information

Project Name _____

Date _____ Type _____

Notes _____

Example: RTAE20-60B-2-E1-DKBZ-VM2

RTAE

E1

SERIES	HEIGHT	SHAFT	THICKNESS	MOUNTING	POLE DRILLING	FINISH	OPTIONS
RTAE = Evolve Round Tapered Aluminum Pole	10=10 ft.	40=4x3" Round	A=0.125"	1 = Single arm mount	E1 = Evolve Round Pole	DKBZ = Dark Bronze BLCK = Black GRAY = Gray <i>* Contact factory for custom color options</i>	GFI ¹ = 20 Amp GFCI Receptacle and Cover EHH ¹ = Extra Handhole C05 ¹ = 0.5" Coupling C07 ¹ = 0.75" Coupling C20 ¹ = 2" Coupling VM2 = 2nd mode vibration damper LAB = Less Anchor Bolts
	12=12 ft.	40=4x3" Round	A=0.125"	2 = Two fixtures at 180°			
	14=14 ft.	40=4x3" Round	A=0.125"	2L = Two fixtures at 90°			
	16=16 ft.	50=5x3" Round	A=0.125"	3T = Three fixtures at 90°			
	18=18 ft.	50=5x3" Round	A=0.125"	3Y = Three fixtures at 120°			
	20=20 ft.	50=5x3" Round	A=0.125"	4 = Four fixtures at 90°			
	25=25 ft.	60=6x4" Round	B=.188"	TA = Tenon (2.375" OD)			
	30=30 ft.	80=8x4.5" Round	B=.188"	TB = Tenon (2.875" OD)			
	35=35 ft.	80=8x4.5" Round	C=.25"	TC = Tenon (3.5" OD)			
	40=40 ft.	80=8x4.5" Round	C=.25"	OT = No drilling (includes pole cap)			

¹ Specify option location using MOUNTING ORIENTATION logic shown below

MOUNTING ORIENTATION

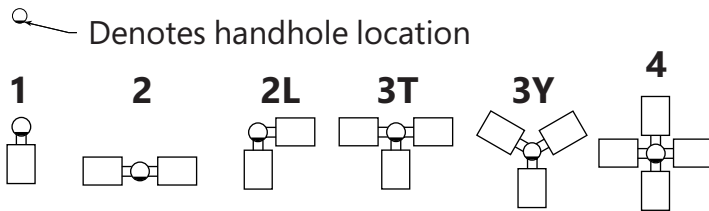

ACCESSORIES- ORDER SEPARATELY

CATALOG NUMBER	DESCRIPTION
VM2SXX*	2nd mode vibration damper

* XX = 08 for 8', 12 for 12', 15 for 16', 20 for 20', and 24' for 24'

DRILL PATTERN E1

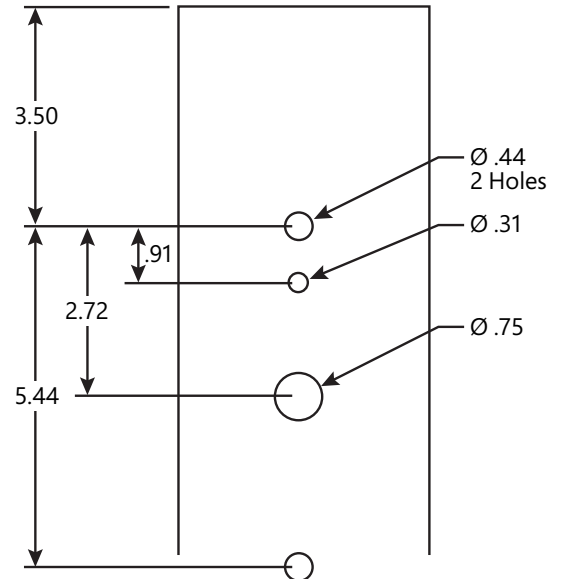

CATALOG NUMBER	HEIGHT		NOMINAL SHAFT DIMENSIONS	WALL THICKNESS	BOLT CIRCLE	BOLT CIRCLE (RANGE)	BASE PLATE SIZE	BASE PLATE SHAPE	ANCHOR BOLT SIZE	BOLT PROJECTION	POLE WEIGHT
	FEET	METERS									
GROUP 1											
RTAE10-40A	10	3.0	4" x 3"	0.125"	7"	-	7.25"	Triangular	3/4"x17"x3"	3.25"	24
RTAE12-40A	12	3.7	4" x 3"	0.125"	7"	-	7.25"	Triangular	3/4"x17"x3"	3.25"	27
RTAE14-40A	14	4.3	4" x 3"	0.125"	7"	-	7.25"	Triangular	3/4"x17"x3"	3.25"	32
RTAE16-50A	16	4.9	5" x 3"	0.125"	8"	-	8.31"	Triangular	3/4"x17"x3"	3.25"	35
RTAE18-50A	18	5.5	5" x 3"	0.125"	8"	-	8.31"	Triangular	3/4"x17"x3"	3.25"	42
RTAE20-50A	20	6.1	5" x 3"	0.125"	8"	-	8.31"	Triangular	3/4"x17"x3"	3.25"	47
GROUP 2											
RTAE20-60B	20	6.1	6" x 4"	0.188"	9.5"	9"-10"	9.75"	Square	1"x36"x4"	4.25"	90
RTAE25-70B	25	7.6	7" x 4"	0.188"	11"	10"-11"	10.5"	Square	1"x36"x4"	4.25"	120
RTAE30-80B	30	9.1	8" x 4.5"	0.188"	11"	11"-12"	11.25"	Square	1"x36"x4"	4.25"	150
RTAE35-80C	35	10.7	8" x 4.5"	0.250"	11"	11"-12"	11.25"	Square	1"x36"x4"	4.25"	205
RTAE40-80C	40	12.2	8" x 4.5"	0.250"	11"	11"-12"	11.25"	Square	1"x36"x4"	4.25"	260

NOTES:

1. Factory supplied template must be used when setting anchor bolts. Current will deny any claim for incorrect anchorage placement resulting from failure to use factory supplied template and anchor bolts.

**EHH
EXTRA
HANDHOLE**

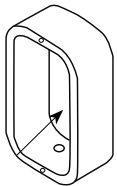

Provision for Grounding

**C05 - C07
- C20 -
COUPLING**

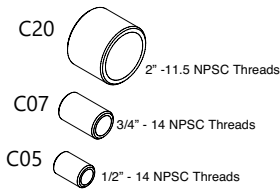

**VM2 -
VIBRATION DAMPER 2ND
MODE**

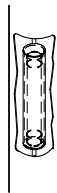

Factory installed, internal damper designed to alter pole resonance to reduce movement and material fatigue caused by 2nd mode vibration.

**VM2SXX -
VIBRATION DAMPER
2ND MODE**



VM2S08 - 8'
VM2S12 - 12'
VM2S16 - 16'
VM2S20 - 20'
VM2S24 - 24'

Field installed, internal damper designed to alter pole resonance to reduce movement and material fatigue caused by 2nd mode vibration.

**GFI - 20 AMP
GFCI RECEPTACLE
& COVER**

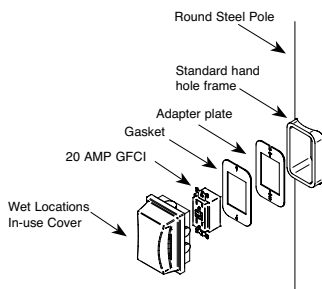

OPTION ORIENTATION

Follow the logic below when ordering location specific options. For each option, include its orientation (in degrees) and its height (in feet).
Example: Option C07 should be ordered as: RTAE20-40A-TA-E1-DBT-CO7-0-15 (.5" coupling on the handhole/arm side of pole, 15 feet up from the pole base) 1' spacing required between option. Consult factory for other configurations.

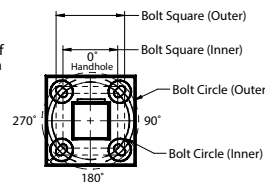
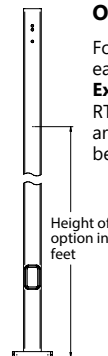

RTAE Series Poles

Round | Tapered | Aluminum

EPA Load Rating - Wind Maps

Project Name _____

Date _____ Type _____

Notes _____

ASCE7-05 WIND MAP

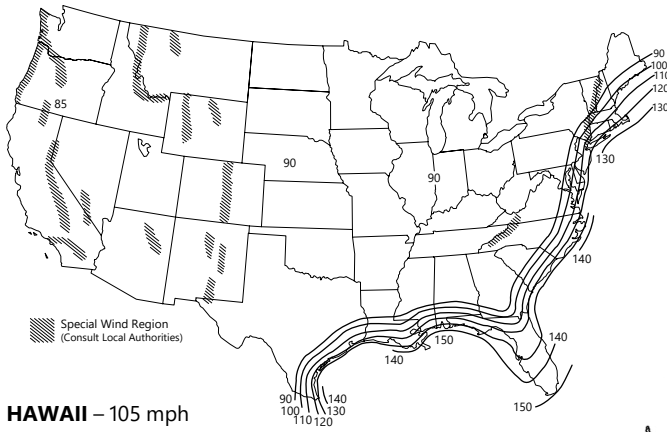

HAWAII – 105 mph
PUERTO RICO – 145 mph

*Printed with permission from ASCE

FLORIDA REGION WIND MAP

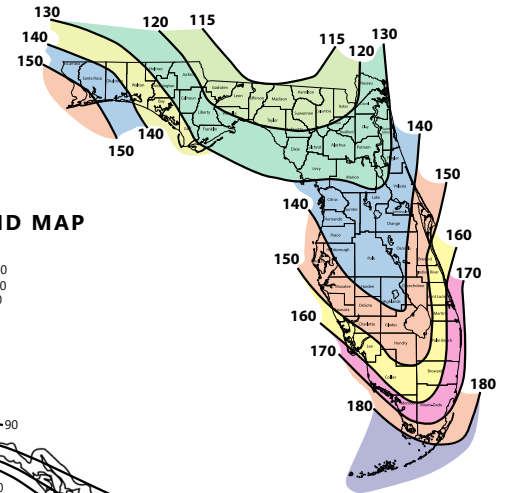

Florida region wind map above is based upon 3-second gust winds and the 2017 Florida Building Code

ALASKA REGION WIND MAP

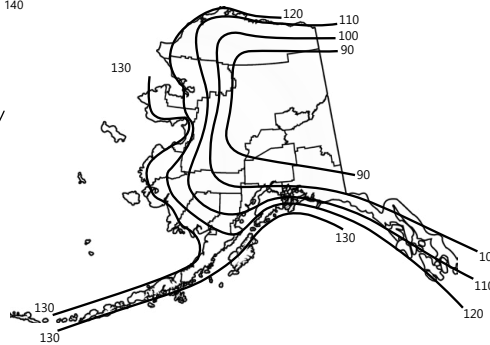

ASCE 7-05 wind map EPA Load Rating - 3 second gust wind speeds (Use for all locations except Florida)									
Catalog Number	Height	85	90	100	110	120	130	140	150
GROUP 1									
RTAE10-40A	10	11.4	10.0	7.8	6.2	5.0	4.0	3.4	2.8
RTAE12-40A	12	9.0	7.8	6.0	4.6	3.6	2.8	2.2	1.8
RTAE14-40A	14	7.0	6.0	4.4	3.4	2.4	1.8	1.4	1.0
RTAE16-50A	16	9.8	8.6	6.4	4.8	3.8	3.0	2.4	2.0
RTAE18-50A	18	8.0	6.8	4.8	3.6	2.8	2.0	1.6	1.2
RTAE20-50A	20	6.2	5.2	3.6	2.4	1.8	1.2	NR	NR
GROUP 2									
RTAE20-60B	20	15.0	12.8	9.9	7.8	6.2	5.0	4.2	3.5
RTAE25-70B	25	14.5	12.5	9.4	7.2	5.5	4.5	3.7	3.0
RTAE30-80B	30	13.9	11.8	8.7	6.6	5.2	4.1	3.3	2.6
RTAE35-80C	35	12.8	10.5	7.6	5.6	4.3	3.4	2.6	1.9
RTAE40-80C	40	8.6	6.9	4.4	2.8	1.9	1.2	NR	NR

Florida Building Code 2017 EPA Load Rating - 3 second gust wind speeds								
Catalog Number	115	120	130	140	150	160	170	180
GROUP 1								
RTAE10-40A	10.2	9.2	7.6	6.5	5.4	4.6	3.8	3.4
RTAE12-40A	8.0	7.0	5.8	4.8	4.0	3.2	2.6	2.2
RTAE14-40A	6.2	5.4	4.4	3.6	2.8	2.2	1.8	1.4
RTAE16-50A	8.8	7.8	6.2	5.2	4.2	3.4	2.8	2.4
RTAE18-50A	6.8	6.0	4.8	3.8	3.0	2.4	2.0	1.6
RTAE20-50A	5.4	4.6	3.4	2.6	2.0	1.6	1.2	NR
GROUP 2								
RTAE20-60B	10.2	9.0	8.8	7.3	6.0	4.9	4.0	3.3
RTAE25-70B	11.7	10.5	8.4	6.8	5.4	4.4	3.5	2.7
RTAE30-80B	11.2	9.9	7.8	6.1	4.7	3.5	2.6	1.8
RTAE35-80C	10.6	9.3	7.1	5.4	4.0	2.9	1.9	1.1
RTAE40-80C	7.5	6.4	4.5	3.1	1.9	1.0	NR	NR

NOTES

1. Allowable EPA, to determine max pole loading weight, multiply allowable EPA by 30 lbs.
2. The tables for allowable pole EPA are based on the ASCE 7-05 Wind Map or the Florida Region Wind Map for the 2010 Florida Building Code. The Wind Maps are intended only as a general guide and cannot be used in conjunction with other maps. Always consult local authorities to determine maximum wind velocities, gusting and unique wind conditions for each specific application
3. Allowable pole EPA for jobsite wind conditions must be equal to or greater than the total EPA for fixtures, arms, and accessories to be assembled to the pole. Responsibility lies with the specifier for correct pole selection. Installation of poles without luminaires or attachment of any unauthorized accessories to poles is discouraged and shall void the manufacturer's warranty
4. Wind speeds and listed EPAs are for ground mounted installations. Poles mounted on structures (such as bridges and buildings) must consider vibration and coefficient of height factors beyond this general guide; Consult local and federal standards
5. Wind Induced Vibration brought on by steady, unidirectional winds and other unpredictable aerodynamic forces are not included in wind velocity ratings. Consult Current's Pole Vibration Application Guide for environmental risk factors and design considerations:
<http://images.salsify.com/image/upload/s--Uk0Lfj10--/bf7prkg0aey64uqoipso>
6. Extreme Wind Events like, Hurricanes, Typhoons, Cyclones, or Tornadoes may expose poles to flying debris, wind shear or other detrimental effects not included in wind velocity ratings

Due to our continued efforts to improve our products, product specifications are subject to change without notice.