

ADJUSTABLE-SHELF

Item number	Finish	Deco Hardware	
		Item number	Qty
VN2THE-36-BK-NT	Black	A500-4PC	5
VN2THE-36-BL-NT	Blue	A500-4ABG	5
VN2THE-36-BS-NT	Bule Steel	A500-4PC	5
VN2THE-36-GR-NT	Grey	A500-4PC	5
VN2THE-36-WH-NT	White	A500-4PC	5
VN2THE-36-DW-NT	Dark Walnut	A500-4ABG	5
VN2THE-36-NO-NT	Natural Oak	A500-4MB	5

Specification:



1. Material: MDF + Plywood + Birch
2. Finish: See Table
3. Hardware: See Table
4. Slides: USE58-300-18 + US-CLIP-4W (4 Set)
5. Hinge: 700.0537.25 + 600.1234.05 (2 Set)
700.0536.25 + 600.1234.05 (2 Set)
6. Shelf Supports: I707BN (4 PCS)
7. The tolerance is +/- 1/8"

<p>hardware resources</p> <p>PROPRIETARY AND CONFIDENTIAL</p> <p>THE INFORMATION CONTAINED IN THIS DRAWING IS THE SOLE PROPERTY OF HARDWARE RESOURCES INC. ANY REPRODUCTION IN PART OR AS A WHOLE WITHOUT THE WRITTEN PERMISSION OF HARDWARE RESOURCES INC. IS PROHIBITED.</p> <p>DO NOT SCALE DRAWING</p>	ITEM:	VN2THE-36	MATERIAL:		
	FINISH:		WEIGHT:	9	
	TOLERANCE UNLESS OTHERWISE SPECIFIED: X ±0.20 X.X ±0.10 X.XX ±0.05 ANGULAR: ±0.5°		UNITS:	DRAWN BY:	DATE:
	SIZE:	APPROVED BY:	RELEASE LEVEL:	REVISION:	

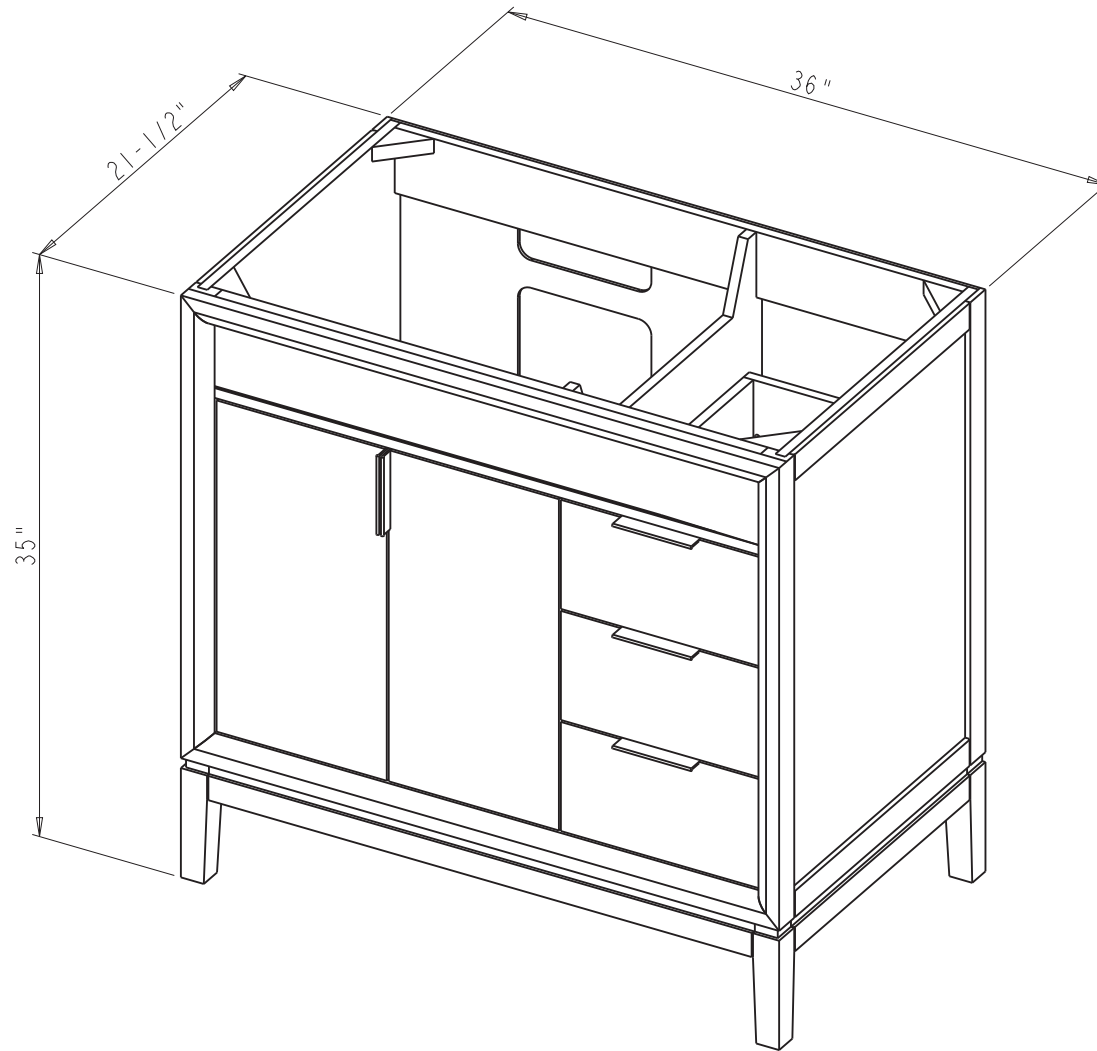

Hugo.cai May-18-21



 PROPRIETARY AND CONFIDENTIAL THE INFORMATION CONTAINED IN THIS DRAWING IS THE SOLE PROPERTY OF HARDWARE RESOURCES INC. ANY REPRODUCTION IN PART OR AS A WHOLE WITHOUT THE WRITTEN PERMISSION OF HARDWARE RESOURCES INC. IS PROHIBITED.	ITEM:	VN2THE - 36		MATERIAL:
	FINISH:			WEIGHT:
				9
				PROJECTION 
	TOLERANCE UNLESS OTHERWISE SPECIFIED:	UNITS:	DRAWN BY:	DATE:
	X ±0.20		<i>Tony.Huang</i>	May-20-21
	X.X ±0.10	SIZE:	APPROVED BY:	DATE:
	X.XX ±0.05			
	ANGULAR: ±0.5°	SHEET:	RELEASE LEVEL:	REVISION:
	DO NOT SCALE DRAWING			

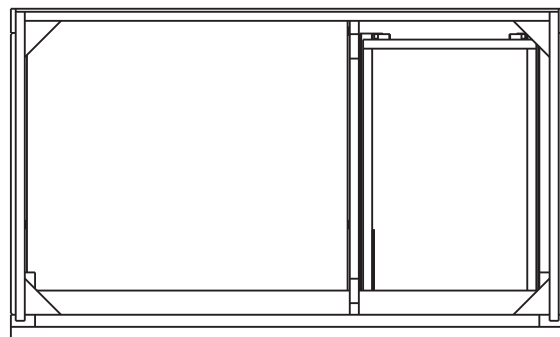
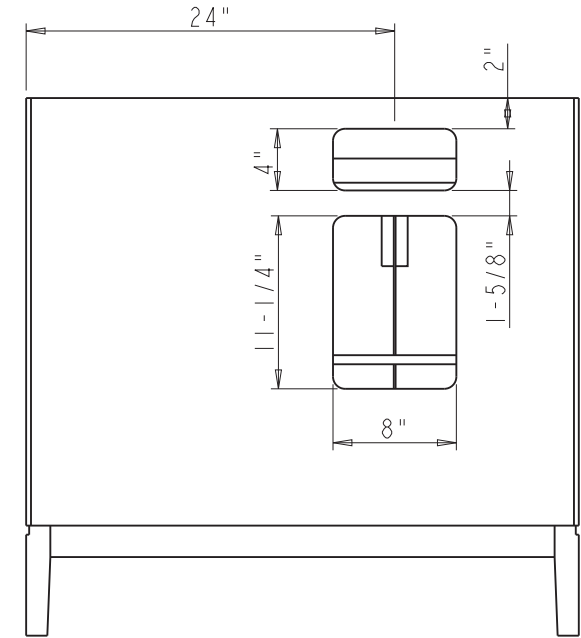
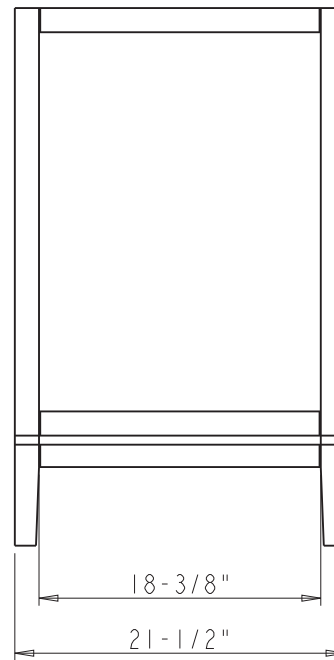
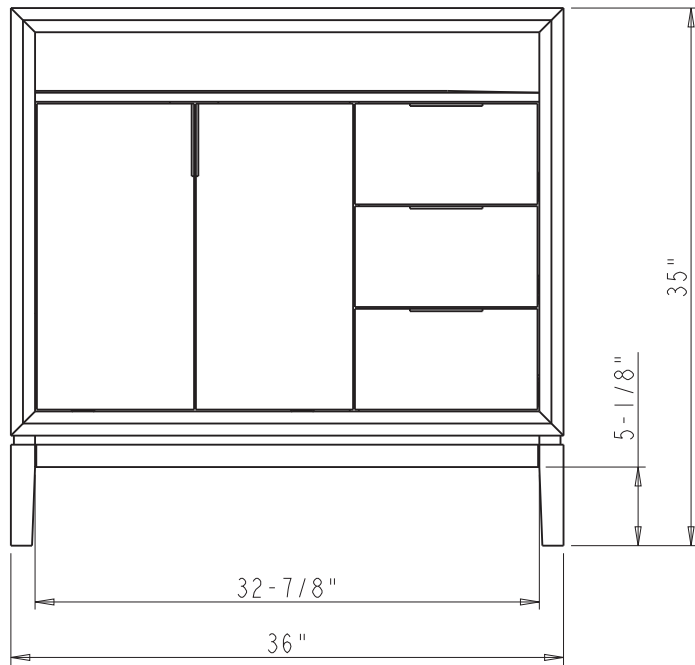

	ITEM#: VN2THE - 36		MATERIAL:	
	FINISH:		WEIGHT:	
PROPRIETARY AND CONFIDENTIAL THE INFORMATION CONTAINED IN THIS DRAWING IS THE SOLE PROPERTY OF HARDWARE RESOURCES INC. ANY REPRODUCTION IN PART OR AS A WHOLE WITHOUT THE WRITTEN PERMISSION OF HARDWARE RESOURCES INC. IS PROHIBITED.	UNITS:		DRAWN BY: <i>Tony.Huang</i>	
	TOLERANCE UNLESS OTHERWISE SPECIFIED: X ±0.20 X.X ±0.10 X.XX ±0.05 ANGULAR: ±0.5°		DATE: May-20-21	
	DO NOT SCALE DRAWING		APPROVED BY:	
			DATE:	
	SHEET:		RELEASE LEVEL:	
			REVISION:	

