

Features

- High-quality solid-brass construction for durability and reliability
- Wall-mount installation
- 22" (559 mm) reach capability

Recommended Products/Accessories

- P25001-00 Deck-Mount Bridge Faucet, Lever Handles
- P25000-00 Pull-Down Kitchen Faucet
- L20311-00 24" Butler Sink
- P30801-00 4" cabinet pull



Codes/Standards











- ASME A112.18.1/CSA B125.1
- NSF/ANSI/CAN 61
- NSF/ANSI/CAN 372

KALLISTA® Five-Year Limited Warranty

See website for detailed warranty information.

Available Colors/Finishes

Color tiles intended for reference only.

Color	Code	Description
	AD	Nickel Silver
	CP	Polished Chrome
	AG	Brushed Nickel
	ULB	Unlacquered Brass
	VS	Stainless
	SN	Polished Nickel
	BGP	Brushed Graphite
	BN	Brushed Nickel
	2MB	Brushed Moderne Brass
	BAF	Brushed French Gold

KALLISTA

Foundations by KALLISTA
Traditional wall-mount kitchen pot filler
P31570-00

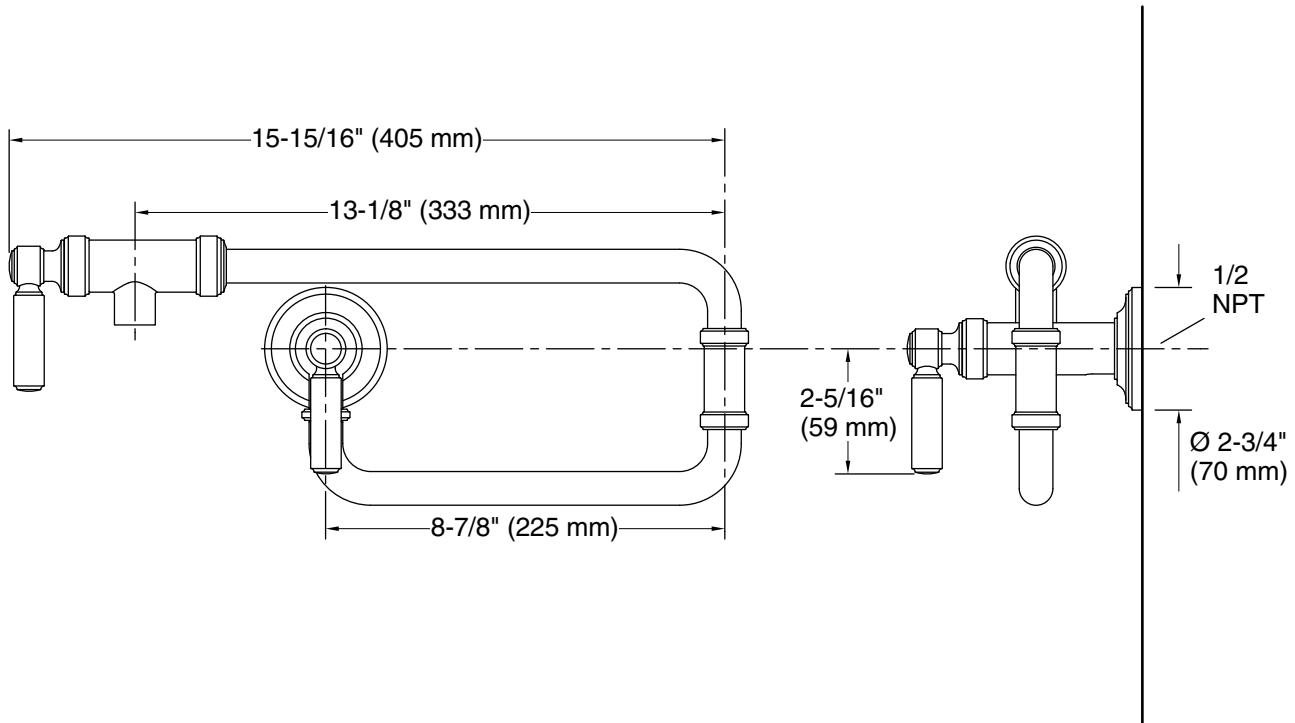

Technical Information

All product dimensions are nominal.

Faucet flow rate: 2.6 gal/min (9.8 l/min)

Notes

Install this product according to the installation instructions.