

ASSEMBLY INSTRUCTIONS





TITAN COLLECTION

ITEM#: U5437-13

DESCRIPTION : TITAN GLIDER RECLINER

Thank you for purchasing this quality product. Be sure to check all packing materials carefully for small parts, which may have come loose during shipment. Identify and count all items and compare with the parts list shown below. It is recommended to have two people during assembling and to remove the back and base of the furniture out from the box. **Please follow the drawings below to assemble the item**

Parts List

NO.	DESCRIPTION	SKETCH	Q'TY
A	Seat		1 PC
B	Backrest		1 PC
C	Left Side Facing (LSF) Wing		1 PC
D	Right Side Facing (RSF) Wing		1 PC



All images shown are for illustration purpose only.
Actual product may vary due to product enhancement.

ASSEMBLY INSTRUCTIONS

TITAN COLLECTION

ITEM#: U5437-13

DESCRIPTION : TITAN GLIDER RECLINER

Step 1:
Check the bottom of the Seat (A) to cut and remove any fastener that is holding the mechanism in place during transportation.

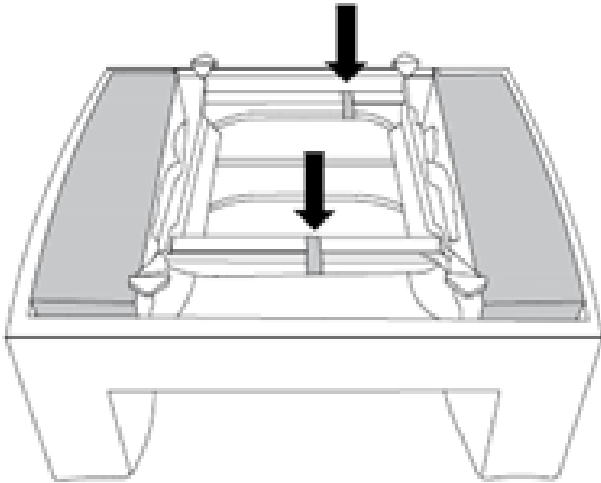

Step 2:
Attach the backrest (B) to the seat (A).

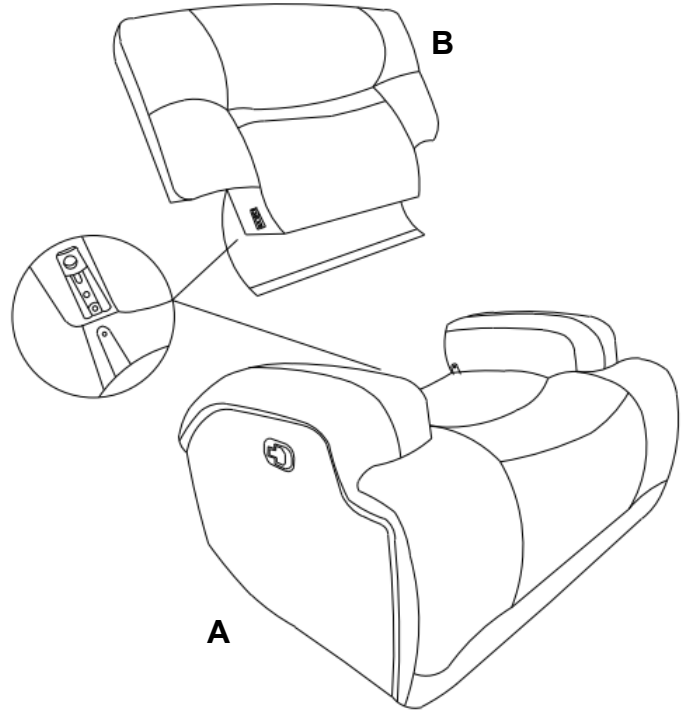

Step 3:
Attach the RSF and LFS Wings (C & D) to the Backrest (B).

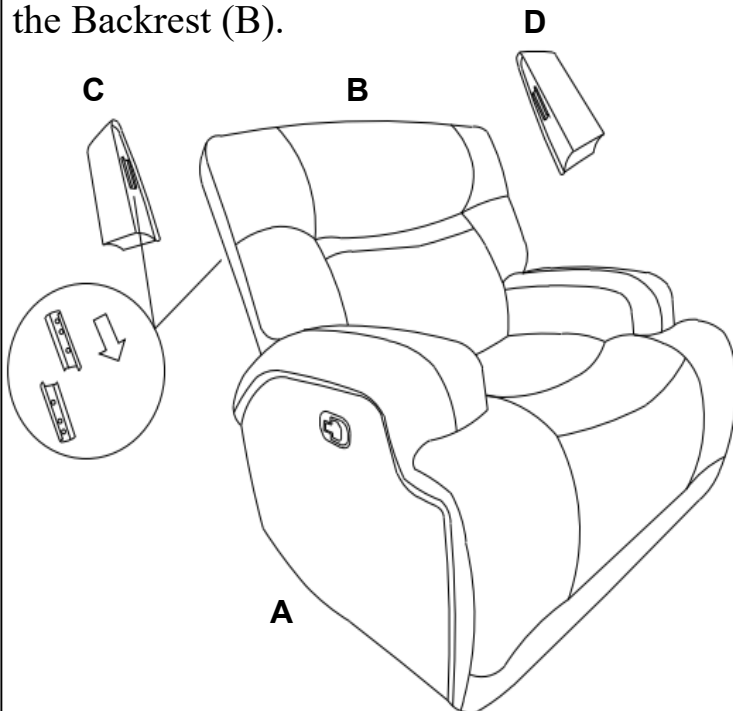

Step 4:
Open the footrest by pulling the handle.

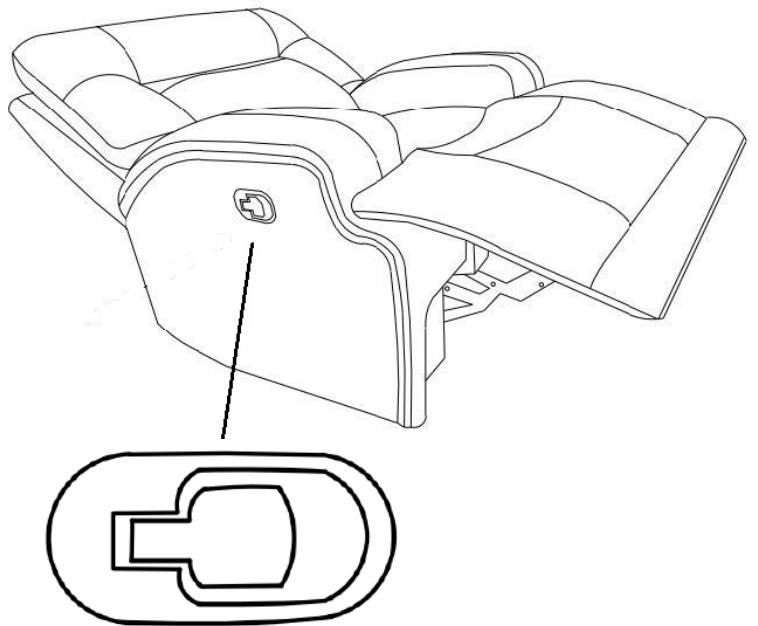

All images shown are for illustration purpose only.
Actual product may vary due to product enhancement.