

ZetaFrame™ Cabinet



Speedy Deployment

- Customer-specified, factory-assembled solution reduces component count, packaging and on-site assembly, saving time and delivery cost
- Order a cabinet integrated with power, cable and thermal management preinstalled under a unique, project-specific part number
- Easy attachment and positioning of accessories allow for faster deployment and maintenance
- Optional shock pallet ensures safe delivery of racked ICT equipment



Fast Selection and Customization – Wide range of standard configurations and one-on-one consultation services allow customers to create a unique solution that meets their exact requirements



Future-Proof Strength – Roll-formed, tubular and fully welded steel frame architecture supports 5,000 lb (2268 kg) static and 4,000 lb (1814 kg) dynamic loads



Integrated Bonding – Doors and panels automatically bond to the frame through door hinges and contact points, eliminating the need for attaching separate grounding straps to cabinet components



Enhanced Cable Management – ZetaFrame's simple and versatile cable management accessories can be used independently or in combinations to accommodate a wide variety of applications



Integrated Airflow Management – Seamless integration with optional airflow management accessories ensures effective conditioned/exhaust air separation and maximum equipment cooling

A highly engineered data center cabinet solution that delivers fast built-to-order configurability, industry-leading strength and scalability, regardless of the application. ZetaFrame Cabinet is a total, turnkey solution that integrates with power, cable and thermal management accessories to support next-generation compute.



with Globally Sourced Components

Global Availability

United States

Simi Valley, CA
800-834-4969

Canada

Toronto, Ontario, Canada
+905-850-7770

Europe

Buckinghamshire, UK
+441628 524834

Middle East & Africa

Dubai, UAE
+971-4-2602125

Doha, Qatar
+974-4-267422

Latin America

Mexico City
+52-55-5203-7525
Toll Free within Mexico
800-201-7592
chatsworth.com.co

Asia Pacific

Shanghai
+86 21 6880-0266
chatsworth.com.cn

chatsworth.com • techsupport@chatsworth.com



SPECIFICATIONS

Description:	<ul style="list-style-type: none"> • Roll-formed, tubular and fully welded steel four-post frame • For indoor use only, in environmentally controlled areas 	
Frame Includes:	<ul style="list-style-type: none"> • Integrated track at the top of the frame supports attachment of cable pathway and airflow containment accessories • Equipment mounting rails, (2) pairs • Leveling feet and load-bearing casters • Floor attachment brackets • Baying kit • PDU bracket, (1) pair, for mounting (2) vertical CPI PDUs side-by-side in one corner of the cabinet • Equipment mounting hardware, (50) M6 Clik-Nut® cage nuts and screws • T25 Torx Bit to secure ground block and other accessories to cabinet frame 	<p>Side Panels:</p> <ul style="list-style-type: none"> • Solid, two-piece panels (half height, full depth). Individual top/bottom panels • Recessed spring-loaded latches with locks, keyed to match doors • Bay cabinets with panels installed or removed • Panels with grommet-sealed cable openings are available as accessories
Equipment Space:	<p>See Height, Width and Depth matrices under Ordering Information/Dimensions</p>	<p>Top Panel:</p> <ul style="list-style-type: none"> • Choice of standard panel or Vertical Exhaust Duct • Standard panel: <ul style="list-style-type: none"> - One-piece solid panel with (4) 3.9"W x 8.8"D (99 mm x 224 mm) grommet- or brush-sealed cable openings, (1) per corner - Unsealed openings are 4.5"W x 9"D (114 mm x 228 mm), large enough to pass large PDU plugs • Vertical Exhaust Duct: <ul style="list-style-type: none"> - Includes the duct and a solid front panel with (2) 3.9"W x 8.8"D (99 mm x 224 mm) brush-sealed cable openings, (1) per corner. A half brush seal is included at the lower rear of the duct - For use with cabinets 41.3" D (1050 mm) or deeper - Select duct size to match the distance between the top of the cabinet and the overhead drop ceiling; the duct features easy height adjustment and a flexible top seal
Equipment Support:	<ul style="list-style-type: none"> • (2) pairs of square-punched mounting rails bolt to frame • Front-to-back adjustable depth • 1-3/4"H (44.5 mm) U spacing, marked and numbered on all rails • 19"W, EIA-310 Universal 5/8"-5/8"-1/2" (15.9 mm – 15.9 mm – 12.7 mm) vertical hole spacing • Rails for cabinets 27.6"W (700 mm) and wider include (4) cable openings per rail. Front rail openings are sealed with grommets. • Cable openings on 27.6"W (700 mm) and 29.5"W (750 mm) cabinets are 5.7"H (145 mm) x 1.9"W (48 mm) • Cable openings on 31.5"W (800 mm) cabinets are 5.7"H (145 mm) x 3.1"W (79 mm) • Optional upgrade to brush-sealed cable openings 	<p>Bottom Panel:</p> <ul style="list-style-type: none"> • Bottom panel is a single-piece solid panel with (2) grommet- or brush-sealed cable openings in the back corners • Unsealed cable openings are 4.5"W x 9"D (114 mm x 228 mm), large enough to pass large PDU plugs • Only available as factory-installed option
Load Capacity	<ul style="list-style-type: none"> • 5000 lb (2268 kg), static load on leveling feet per UL 2416 • 4000 lb (1814 kg), rolling load on casters per UL 2416 for depths 1000 mm or greater • 4000 lb (1814 kg), shipping load on shock pallet 	<p>Airflow Management:</p> <ul style="list-style-type: none"> • Air Dam: <ul style="list-style-type: none"> - Configure with cabinet or available separately as an accessory - Air Dam blocks airflow around the sides and top of the equipment mounting space, so conditioned air passes through equipment, preventing exhaust air from recirculating - Requires a minimum rail setback of 1.4" (36 mm) from the front of the cabinet frame; maximum rail setback is 13.7" (348 mm) • Air Director: <ul style="list-style-type: none"> - Configure with cabinet or available separately as an accessory - For use in higher heat load applications - Air Director is an angled panel used at the back of cabinets with Vertical Exhaust Duct configurations to guide exhaust air toward the top of the cabinet - Attaches to the bottom slide on the cabinet, adjusts in depth
Certifications:	<ul style="list-style-type: none"> • EIA-310 compliant • UL Listed 2416, NWIN, File #E227626 	
Transportation Tests:	<ul style="list-style-type: none"> • Transportation tests apply to Shock Pallet option • Meets requirements per the International Safe Transit Association (ISTA) 2B • ASTM D4169 Truck Assurance Levels: low, medium and high • ASTM D4169 Air Assurance Levels: I, II and III 	
Materials:	<ul style="list-style-type: none"> • Steel frame, rails and panels • Plastic grommets/seals 	<p>Cable Management:</p> <ul style="list-style-type: none"> • Vertical Cable Manager, Cable Lashing Panel and Front-to-Rear Cable Manager are available as accessories. • Go to the Ordering Information for details
Finish:	<ul style="list-style-type: none"> • Powder coat paint on frame, rails and panels in Black or Glacier White • Brushes/seals, door handles/hinges are black 	
Doors/Lock Kits:	<ul style="list-style-type: none"> • Hinge pins allow easy removal of doors during maintenance • Reversible to open from the right or left, must move hinges/latch • Interchangeable front or rear, must move hinges/latch • Swing handle • Keyed lock • Front door: <ul style="list-style-type: none"> - 78% perforation - Single-point latch mechanism - Opens to 120° when bayed, 145° when not bayed • Rear doors: <ul style="list-style-type: none"> - Choice of single solid or double 78% perforated doors - Three-point latch mechanism - Solid door includes a perimeter seal; use with Vertical Exhaust Duct configurations - Single and Double doors open to 180° when bayed or not bayed - Compatible with RFID Electronic Lock Kit 	<p>Bonding and Grounding:</p> <ul style="list-style-type: none"> • (1) grounding block for 6 AWG conductor is included to attach the frame to ground in four possible locations: top/bottom, front/rear <p>PDU Brackets:</p> <ul style="list-style-type: none"> • (1) pair of brackets and installation hardware for use with CPI eConnect® PDUs or vertical Power Strips • Supports (2) 2.2"W (56 mm) or narrower PDUs side-by-side or one PDU up to 4"W (101.6 mm) • Attaches to the frame in any corner • Provides tool-less attachment points spaced 61-1/4" (1556 mm) apart on all cabinets • Provides alternate tool-less attachment points spaced 64-3/4" (1645 mm) on cabinets 45U or taller • Full-height brackets are available as accessories

 **Powered by Intelligence**

Configure a cabinet with intelligent PDUs, RFID electronic locks and environmental sensors preinstalled.
Contact [Technical Support](#).

ZETAFRAME CABINET DETAIL FEATURES:

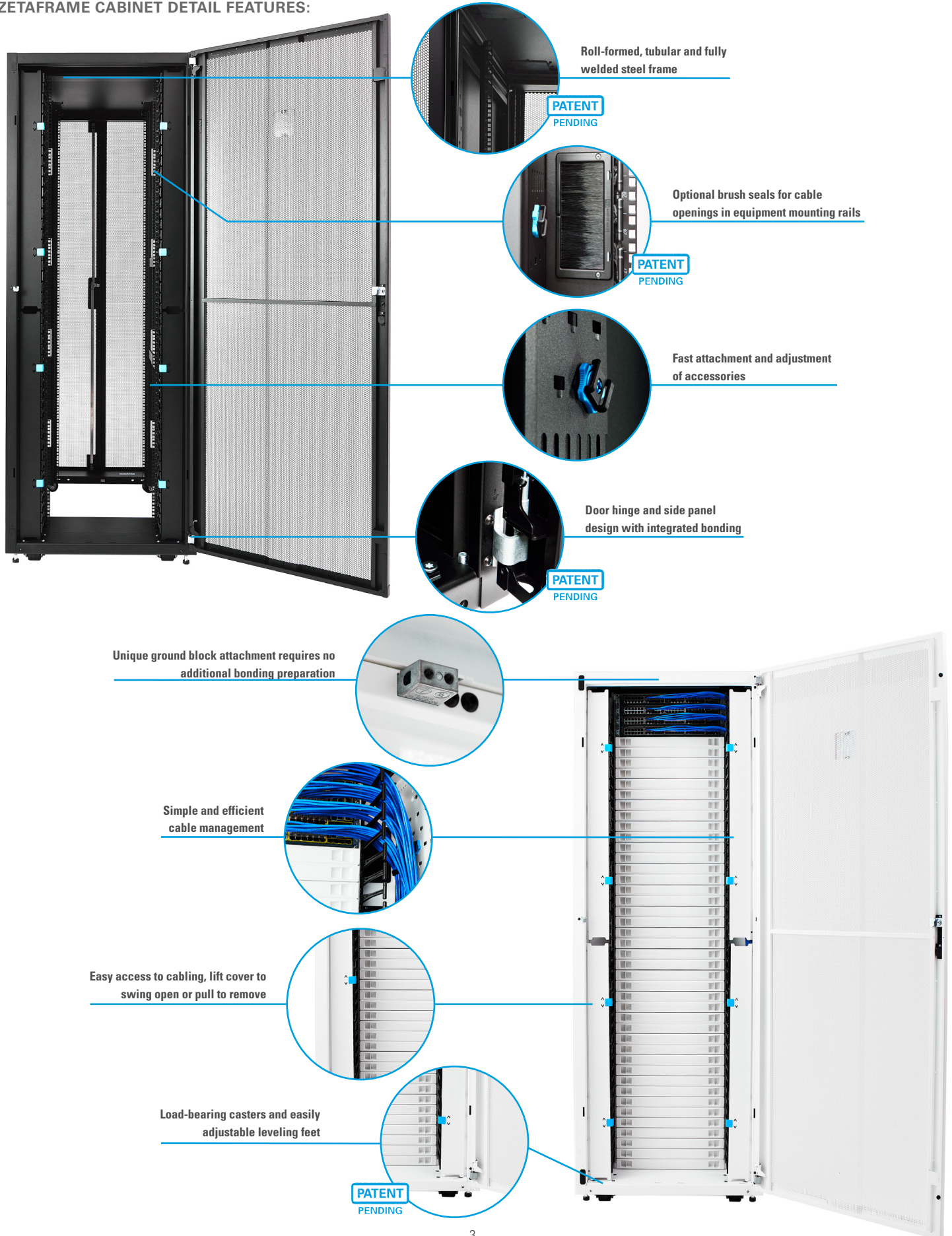

Roll-formed, tubular and fully welded steel frame

PATENT PENDING

Optional brush seals for cable openings in equipment mounting rails

PATENT PENDING

Fast attachment and adjustment of accessories

Door hinge and side panel design with integrated bonding

PATENT PENDING

Unique ground block attachment requires no additional bonding preparation

Simple and efficient cable management

Easy access to cabling, lift cover to swing open or pull to remove

Load-bearing casters and easily adjustable leveling feet

PATENT PENDING

ORDERING INFORMATION

Use the part number configurator below to select a standard ZetaFrame Cabinet.

Choose the Height, Width, Depth, Panels, Thermal Configuration and Color. Example part number: ZB45-A120A-E1

Ships on Standard Pallet or Shock Pallet

Z	1	2	3	-	4	5	6	7	8	-	9	10
1. Height								10. Shipping				
U	in	mm						1 Standard Pallet				
42	79.4	2017	A					2 Shock Pallet				
45	84.6	2149	B					<i>Shock Pallet is available for 42U, 45U, 48U cabinet heights and 43.3"D (1100 mm) and 47.2"D (1200 mm) cabinet depths.</i>				
48	89.9	2283	C					9. Color				
52	96.9	2461	D					7 Black				
<i>Height includes casters.</i>								E Glacier White				
2. Width								8. Thermal Management				
in	mm							0 None				
23.6	600	1						A Air Dam				
27.6	700	2						B Air Dam, Brushed-Sealed Rail				
29.5	750	3						<i>Brush-Sealed Front Rails are not available for 23.6"W (600 mm) cabinets.</i>				
31.5	800	4						7. Bottom Panel				
3. Depth								0 None				
in	mm							1 Grommet-Sealed				
31.5	800	1						2 Brush-Sealed				
39.4	1000	2						6. Side Panel				
41.3	1050	3						0 None				
43.3	1100	4						1 1 Side				
47.2	1200	5						2 2 Sides				
<i>Frame depth does not include doors. See detailed dimensions on page 6.</i>								5. Top Panel				
4. Doors								0 None				
None			0					1 Grommet-Sealed				
Single Perforated Front/ Double Perforated Rear			A					2 Brush-Sealed				
No Front/ Double Perforated Rear			B									



Notes: All cabinets ship with two pairs of square-punched equipment mounting rails. Rails for 27.6"W (700 mm) and wider cabinets include four grommet-sealed cable openings (per rail). See page 8 for detailed dimensions. Other sizes and configurations are available. Contact Technical support at techsupport@chatsworth.com for more information.



Configure It!

Take advantage of CPI's expertise and configure a complete solution, including eConnect® PDUs, RFID Electronic Locks and environmental sensors under a single part number. Custom solutions are also available through CPI's design engineering services. Email us at: techsupport@chatsworth.com

INSTALLATION PRODUCTS

Part Number	Description	Shipping Weight lb (kg)
39150-001	Leveling Feet Height Adjustment Tool, 5 mm Hex Ball Driver, 12"L (300 mm)	1 (0.5)
39207-701	Ramp Kit for Shock Pallet Cabinets, Black	26 (11.8)
76543-001*	Clik-Nut Hardware Kit, Cage Nuts, Screws, M6, 25 Pack, Zinc	1 (0.5)



Clik-Nut Hardware Kit



Leveling Feet Height Adjustment Tool

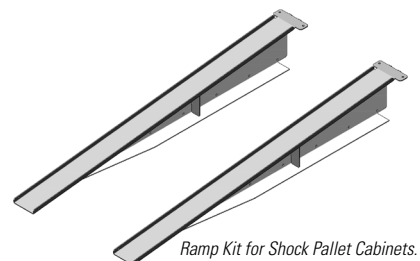

Ramp Kit for Shock Pallet Cabinets.

Note: Baying Kits and Floor Mounting Brackets are included with each cabinet. * Additional thread size and quantities available.

Shock pallet option allows integrators to reship up to 4000 lb (1814 kg) of installed equipment.

ORDERING INFORMATION

Use the part number configurator below to create a standard ZetaFrame Cabinet with a Vertical Exhaust Duct. Choose the Height, Width, Depth, Panels, Thermal Configuration and Color. Example part number: ZB45-DB22B-71

Vertical Exhaust Duct Configuration for Front-to-Top Airflow

Z		1	2	3	-	4	5	6	7	8	-	9	10
1. Height													
U	in	mm											
42	79.4	2017	A										
45	84.6	2149	B										
48	89.9	2283	C										
52	96.9	2461	D										
<i>Height includes casters.</i>													
2. Width													
in	mm												
23.6	600	1											
27.6	700	2											
29.5	750	3											
31.5	800	4											
3. Depth													
in	mm												
41.3	1050	3											
43.3	1100	4											
47.2	1200	5											
<i>Frame depth does not include doors. See detailed dimensions on page 6.</i>													
4. Doors													
Single Perforated Front/ Single Solid Rear		D											
No Front/ Single Solid Rear		E											
5. Top Panel													
A	15-20" H (381 - 508 mm) Vertical Exhaust Duct												
B	20-34" H (508 - 863 mm) Vertical Exhaust Duct												
C	34-60" H (863 - 1524 mm) Vertical Exhaust Duct												
D	15-20" H (381 - 508 mm) Vertical Exhaust Duct, Air Director												
E	20-34" H (508 - 863 mm) Vertical Exhaust Duct, Air Director												
F	34-60" H (863 - 1524 mm) Vertical Exhaust Duct, Air Director												
<i>A half brush seal is included at the lower rear of the duct.</i>													
6. Side Panel													
0	None												
1	1 Side												
2	2 Sides												
<i>At least one side panel between adjacent cabinets and bottom panel are recommended for optimal thermal performance.</i>													
7. Bottom Panel													
0	None												
1	Grommet-Sealed												
2	Brush-Sealed												
8. Thermal Management													
A	Air Dam												
B	Air Dam, Brushed-Sealed Front Rail												
<i>Brush-Sealed Front Rails are not available for 23.6"W (600 mm) cabinets.</i>													
9. Color													
7	Black												
E	Glacier White												
10. Shipping													
1	Standard Pallet												

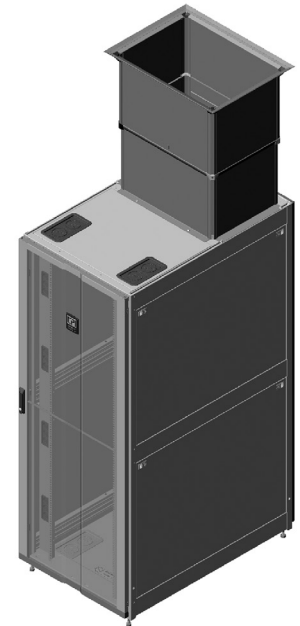

Notes: All cabinets ship with two pairs of square-punched equipment mounting rails. Rails for 27.6"W (700 mm) and wider cabinets include four grommet-sealed cable openings (per rail). See page 8 for detailed dimensions. Other sizes and configurations are available. Contact Technical support at techsupport@chatsworth.com for more information.



Configure It!

Take advantage of CPI's expertise and configure a complete solution, including eConnect® PDUs, RFID Electronic Locks and environmental sensors under a single part number. Custom solutions are also available through CPI's design engineering services. Email us at: techsupport@chatsworth.com

SUPPORT PRODUCTS

Cable Pathway Elevation Kits			
Part Number		Description	Shipping Weight lb (kg)
1 Tier	2 Tier		
60508-X02	60508-X22	2", 2.5", 3"H (50 mm, 64 mm, 75 mm)	3.1
60508-X06	60508-X26	4", 5", 6"H (100, 127, 150 mm)	3.8
60508-X08	N/A	10", 11", 12"H (250 mm, 280 mm, 300 mm)	5.5

Note: X=Color: 7=Black, E=Glacier White. Shipping weight is for 1 Tier Elevation Kit.



1 Tier



2 Tier

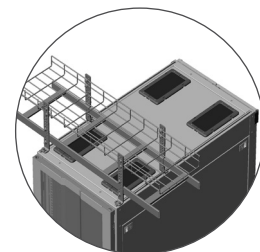

Supports CPI Cable Runway or Pemsar® Rejiband® Wire Mesh Cable Tray above a continuous row of ZetaFrame Cabinets, providing additional space between the tops of the cabinets and the cable runway and trays.

DIMENSION TABLES

Height Dimensions - in (mm)			
Rack Mount Spaces (U)	Overall with Casters	Frame Only No Casters	Front Opening
42	79.4 (2016)	77.4 (1965)	73.7 (1873)
45	84.6 (2149)	82.6 (2099)	79.0 (2006)
48	89.9 (2282)	87.9 (2232)	84.2 (2139)
52	96.9 (2460)	94.9 (2410)	91.2 (2317)

Casters add approximately 2" (51 mm) to frame and are factory-installed on the cabinet. Brush-sealed grommets in the top panel add approximately 3/8" (9 mm) to the height of the cabinet.

Width Dimensions - in (mm)			
Nominal Width	Overall with Side Panels	Front Opening	Rack-Mount Width
23.6 (600)	23.6 (600)	19.9 (506)	19 (482.6)
27.6 (700)	27.6 (700)	23.9 (607)	19 (482.6)
29.5 (750)	29.5 (750)	25.8 (655)	19 (482.6)
31.5 (800)	31.5 (800)	27.8 (707)	19 (482.6)

Mounting Rail clearance is 17.8" (452 mm), mounting hole spacing is 18.3" (465 mm).

Depth Dimensions - in (mm)			
Nominal Depth	Overall with Doors	Frame Only No Doors	Maximum Rail Depth
31.5 (800)	34.6 (879)	31.5 (800)	28.5 (723)
39.4 (1000)	42.5 (1080)	39.4 (1000)	36.4 (923)
41.3 (1050)	44.4 (1128)	41.3 (1050)	38.3 (973)
43.3 (1100)	46.4 (1179)	43.3 (1100)	40.3 (1023)
47.2 (1200)	50.3 (1278)	47.2 (1200)	44.2 (1123)

Front Door is approximately 1.6"D (41 mm) and Rear Door is approximately 1.5"D (38 mm). Minimum rail depth is 7" (178 mm), each rail is 3.5"D (89 mm). Rail depth is reduced when vertical accessories are placed in corners.

DIMENSION DRAWINGS

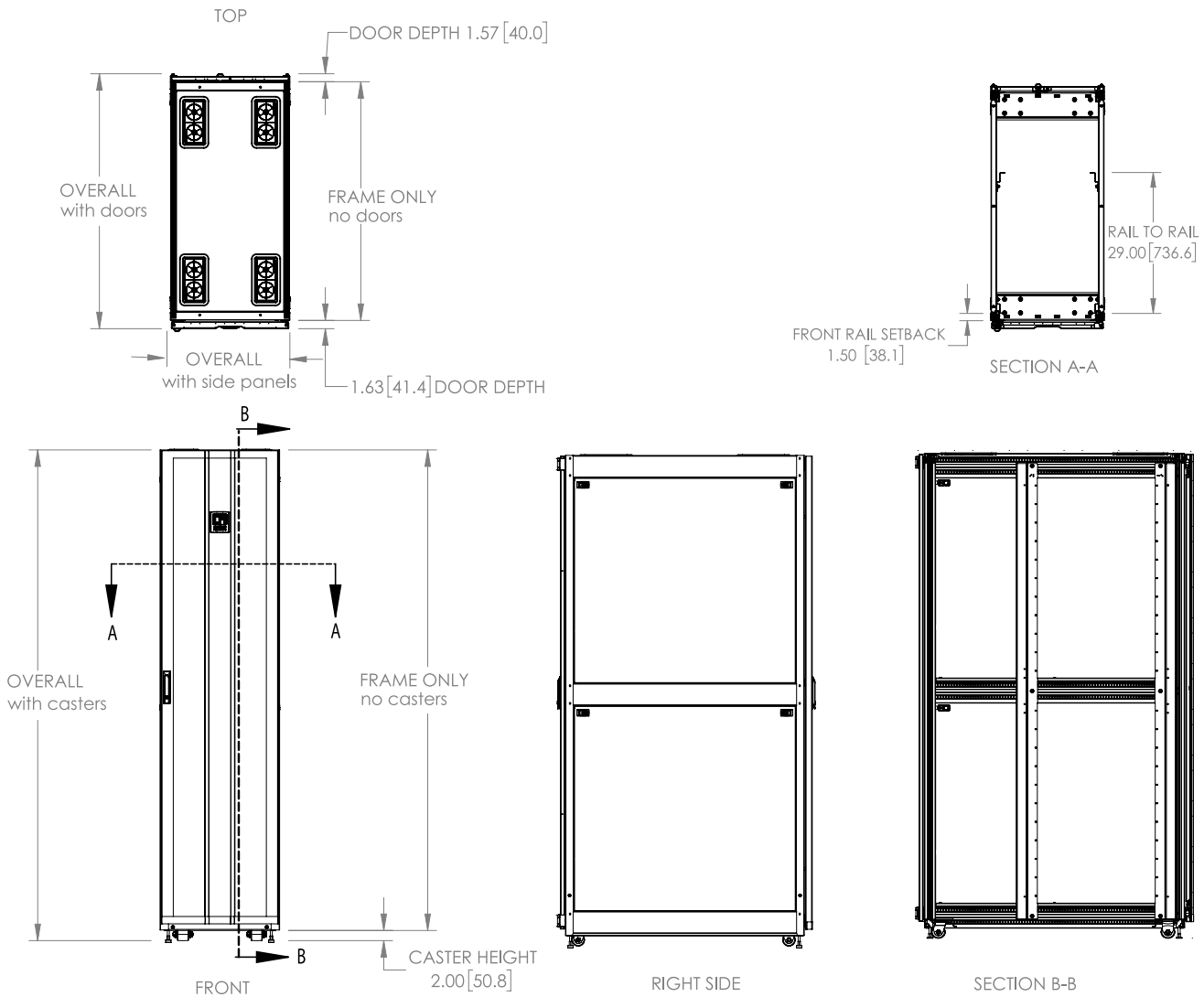

THERMAL MANAGEMENT ACCESSORIES

To optimize cooling performance in your facility, you must isolate conditioned and exhaust air, guide conditioned air to equipment and remove exhaust air from equipment. Thermal management accessories play a critical role in overall performance by controlling airflow inside the cabinet.

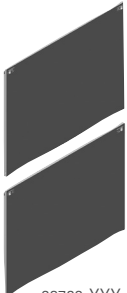

39763-XXX

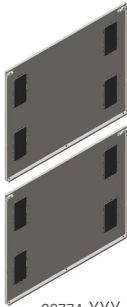

39774-XXX

Side Panels

- Available in Solid or with Grommets; Configure solid side panels with cabinet or available separately as an accessory.
- Includes: Side panel (two halves, solid or with grommets), set of keys
- Two-piece design with top and bottom halves for easier handling
- Tool-less removal, drop-in design with integrated locking spring latch secures the side panel to the cabinet frame
- Features integral bonding, no bonding strap required
- Side Panel with Grommets feature multiple grommet-sealed cable openings, allowing cables to enter the side of the cabinet while containing exhaust air within each cabinet
- Side Panel with Grommets feature (8) cable openings per side, (4) per half-height panel, (1) per corner; Cable opening size without grommet is 4.5"W x 9"D (114 mm x 228 mm), sized for large power plugs
- Grommets are plastic, snap-on and can be cut to pass cables



Cable Port Brush Kit

- Use to replace grommets in top, bottom, or side panels
- Cable opening is 3.9"W x 8.8"D (99 mm x 224 mm)

Side Panels for ZetaFrame Cabinet							
Solid	Part Number				Cabinet Frame Depth in (mm)	Shipping Weight lb (kg)	
	Grommet	Height (U)					
		42	45	48			52
39763	39774	-X00	-X51	-XAC	-XDL	31.5 (800)	34 (15.5)
		-X08	-X59	-XAL	-XDW	39.4 (1000)	41 (18.6)
		-X10	-X61	-XAN	-XEA	41.3 (1050)	43 (19.1)
		-X12	-X63	-XAR	-XEC	43.3 (1100)	45 (20.2)
		-X16	-X67	-XAW	-XEG	47.2 (1200)	48 (21.7)

Note: X=color: 7=Black, E=Glacier White. Shipping weights are for 52U configurations

Part Number	Description	Shipping Weight lb (kg)
25190-001	Cable Port Brush Kit, Pack of 2, Black	2 (0.9)

Air Dam Kit

Air Dam blocks airflow around the sides and top of the equipment mounting space, so conditioned air passes through equipment and exhaust air does not recirculate around equipment. Configure with cabinet or available separately as an accessory.

- Use with Equipment Mounting Rail Grommet Brush Kit and Bottom Panel
- Includes: Top, bottom and side baffles; installation hardware
- 600 mm attaches by wrapping around flange, 700, 750 & 800 mm attaches by snapping onto half lance
- Requires a minimum rail setback of 1.4" (36 mm) from the front of the cabinet frame; maximum rail setback is 13.7" (348 mm)
- Flexible seal against top and side panels
- Select part number to match the frame style, width, usable height and color of the cabinet
- Material: Steel, sheet metal, plastic seals
- Finish: Black or Glacier White; seals are black



Air Dam Kit for ZetaFrame Cabinet					
Part Number - Cabinet Width				Height (U)	Shipping Weight lb (kg)
23.6"W (600 mm)	27.6"W (700 mm)	29.5"W (750 mm)	31.5"W (800 mm)		
38649-X44	38649-X55	38649-X77	38649-X66	42	11 (5.0)
38649-X47	38649-X58	38649-X80	38649-X69	45	11 (5.0)
38649-X50	38649-X61	38649-X83	38649-X72	48	11 (5.0)
38649-X54	38649-X65	38649-X87	38649-X76	52	12 (5.1)

Note: X=color: 7=Black, E=Glacier White. Shipping weights are for 800 mm configurations

Air Director

Air Director is an angled panel used at the back of cabinets for higher heat load applications with Vertical Exhaust Duct top panels to guide exhaust air toward the top of the cabinet. Configure with cabinet or available separately as an accessory

- Attaches to the bottom slide on the cabinet, adjusts in depth
- Select part number to match width and color of the cabinet
- Material: Steel
- Finish: Black or Glacier White

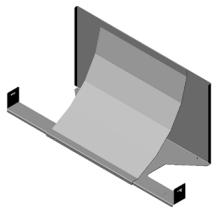

Air Director for ZetaFrame Cabinet		
Part Number	Description	Shipping Weight lb (kg)
39802-X00	For 23.6"W (600 mm) Cabinets	12 (5.2)
39802-X01	For 27.6"W (700 mm) Cabinets	13 (5.9)
39802-X02	For 29.5"W (750 mm) Cabinets	14 (6.2)
39802-X03	For 31.5"W (800 mm) Cabinets	15 (6.5)

Note: X=color: 7=Black, E=Glacier White.

THERMAL MANAGEMENT ACCESSORIES



39731-XXX

Equipment Mounting Rail Grommet Kit

Set of (8) flexible plastic grommets that cover cable openings in the equipment mounting rails to block airflow around equipment. Configure with cabinet or available separately as an accessory.

- Grommets are plastic. Trim as needed to form seal around cables
- Not compatible with 23.6"W (600 mm) cabinet
- UL 94-V0 flammability rating

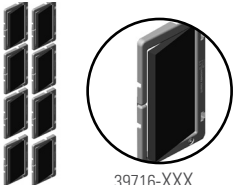

39716-XXX

Equipment Mounting Rail Brush Kit (Patent Pending)

Set of (8) brush covers that conceal cable openings in the equipment mounting rails to block airflow around equipment. Configure with cabinet or available separately as an accessory.

- Allows for quick cable installation through mounting rails while maintaining a seal
- Suited for high cable density applications
- Split bezel design does not capture cables and allows for retrofitting around existing cables
- Not compatible with 23.6"W (600 mm) cabinets
- UL 94-V0 flammability rating
- Material: Plastic housing, nylon brushes

Equipment Mounting Rail Kits for ZetaFrame		
Part Number	Description	Shipping Weight lb (kg)
39731-001	Grommet Kit, for 27.6"W (700 mm) and 29.5"W (750 mm) Cabinets; Pack of 8; Black	2 (0.9)
39731-002	Grommet Kit, for 31.5"W (800 mm) Cabinet; Pack of 8; Black	2 (0.9)
39716-001	Brush Kit, for 27.6"W (700 mm) and 29.5"W (750 mm) Cabinets; Pack of 8; Black	2 (0.9)
39716-002	Brush Kit, for 31.5"W (800 mm) Cabinet; Pack of 8; Black	3 (1.4)

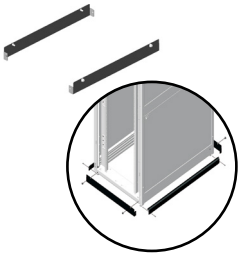

Seal Kit Installation

Cabinet To Floor Seal Kits

Place at the bottom of cabinets to seal the space between the bottom of the cabinet and the floor when leveling feet or casters are in use. Ideal for aisle containment applications.



Snap-In Filler Panel

Snap-In Filler Panel blocks airflow in between equipment by sealing unused rack-mount spaces (U) in the cabinet. Use with Air Dam Kit and Bottom Panel to separate cold and hot air within the cabinet.



4" Round Grommet

Raised Floor Grommets

Raised Floor Grommets provide a reliable seal around cable bundles. Split design allows for retrofitting over existing cable bundles in access floor tiles.

Additional Thermal Management Accessories		
Part Number	Description	Shipping Weight lb (kg)
Floor Seal Kit, Front and Rear		
39996-X00	For 23.6"W (600 mm) Cabinet	4.0 (1.8)
39996-X01	For 27.6"W (700 mm) Cabinet	4.2 (1.9)
39996-X02	For 29.5"W (750 mm) Cabinet	4.3 (2.0)
39996-X03	For 31.5"W (800 mm) Cabinet	4.4 (2.0)
Floor Seal Kit, Sides		
39997-X00	For 31.5"D (800 mm) Cabinet	4.4 (2.0)
39997-X08	For 39.4"D (1000 mm) Cabinet	5.8 (2.6)
39997-X10	For 41.3"D (1050 mm) Cabinet	6.3 (2.9)
39997-X12	For 43.3"D (1100 mm) Cabinet	6.9 (3.1)
39997-X16	For 47.2"D (1200 mm) Cabinet	7.9 (3.6)
Snap-In Filler Panels		
34537-X00	1U x 19"W (482.6 mm), Single	14 (6.4)
34537-X01	1U x 19"W (482.6 mm), 6 Pack	14 (6.4)
34537-X02	1U x 19"W (482.6 mm), 50 Pack	14 (6.4)
34538-X00	2U x 19"W (482.6 mm), Single	21 (9.5)
34538-X01	2U x 19"W (482.6 mm), 6 Pack	21 (9.5)
34538-X02	2U x 19"W (482.6 mm), 50 Pack	21 (9.5)
Raised Floor Grommet		
13671-001	Floor Grommet, with Hardware, Single, Black	2 (1.4)
13671-002	Floor Grommet, with Hardware, 10 Pack, Black	18 (8.2)
13874-001	4" (102 mm) Round Raised Floor Grommet, with Hardware, Single, Black	1 (0.5)
13874-002	4" (102 mm) Round Raised Floor Grommet, with Hardware, 10 Pack, Black	6 (2.7)

Note: Seal Kits: X=Color: 7=Black, E=Glacier White.
 Filler Panels: X=Color: 0=Black, E=Glacier White.

CABLE MANAGEMENT ACCESSORIES

Keep network cables separate and organized using the following cable management accessories.

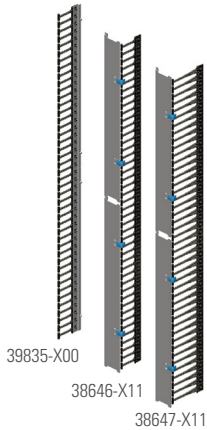

Vertical Cable Manager

- Fully compatible with Air Dam Kit and Cable Lashing Panel
- Openings between fingers align with each U on the mounting rail
- Short or long plastic T-shaped finger options
- Rail setback:
 - 7-1/4" (184 mm) for Managers with long fingers
 - 4-3/4" (121 mm) for Managers with short fingers
- Long fingers pass up to (48) cables per U space through openings
- Short fingers pass up to (24) cables per U space through openings
- Hinged cover included with managers in cabinets wider than 600 mm
- Material: aluminum panels, fingers and latches are plastic
- Finish: Black or Glacier White; fingers are black, hinges/latches are blue
- Select part number to match cabinet usable height, width and color of the cabinet

Vertical Cable Manager for ZetaFrame Cabinet					
Part Number - Cabinet Width				Height (U)	Shipping Weight lb (kg)
23.6"W (600 mm)	27.6"W (700 mm)	29.5"W (750 mm)	31.5"W (800 mm)		
Vertical Cable Manager with Long Fingers					
N/A	38647-X11	38647-X22	38647-X33	42	9 (4.1)
N/A	38647-X14	38647-X25	38647-X36	45	10 (4.5)
N/A	38647-X17	38647-X28	38647-X39	48	10 (4.5)
N/A	38647-X21	38647-X32	38647-X43	52	10 (4.5)
Vertical Cable Manager with Short Fingers					
39835-X00	38646-X11	38646-X22	38646-X33	42	9 (4.1)
39835-X03	38646-X14	38646-X25	38646-X36	45	10 (4.5)
39835-X06	38646-X17	38646-X28	38646-X39	48	10 (4.5)
39835-X10	38646-X21	38646-X32	38646-X43	52	10 (4.5)

Note: X=Color: 7=Black, E=Glacier White. Shipping weights are for 800 mm configurations.

Inside Dimensions, Usable Internal Area, Rail Setback, U Opening					
Cabinet Width	Width in (mm)	Depth in (mm)	Cable Area in ² (mm ²)	Rail Setback in (mm)	U Opening in ² (mm ²)
Vertical Cable Manager with Long Fingers					
27.6 (700)	2.2 (56)	7.5 (191)	17.0 (10 967)	10.1 (257)	6.6 (460)
29.5 (750)	3.2 (81)	7.5 (191)	24.5 (15 806)	10.1 (257)	6.6 (460)
31.5 (800)	4.2 (107)	7.5 (191)	31.9 (20 580)	10.1 (257)	6.6 (460)
Vertical Cable Manager with Short Fingers					
23.6 (600)	0.4 (10)	5 (127)	1.8 (1161)	7.6 (193)	3.5 (2260)
27.6 (700)	2.2 (56)	5 (127)	11.2 (7225)	7.6 (193)	3.5 (2260)
29.5 (750)	3.2 (81)	5 (127)	16.2 (10 451)	7.6 (193)	3.5 (2260)
31.5 (800)	4.2 (107)	5 (127)	21.2 (13 677)	7.6 (193)	3.5 (2260)

Rail setback is the minimum distance required between the front edge of the cabinet frame and the front edge of the equipment mounting rail. U opening is the size of the side opening at each U space between T-shaped fingers.

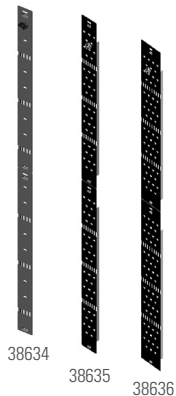

Cable Lashing Panel

- Creates simple, vertical pathways for small cable bundles
- Attaches to cabinet frame, adjusts in depth independent of the mounting rails; Can be installed adjacent to Vertical Cable Manager
- Includes: Brackets, Cable Bundle Swivels and installation hardware
- Available in 3 widths: 2-3/4"W (70 mm), 4.5"W (115 mm) and 7"W (178 mm)
- 2-3/4"W (70 mm) includes (6) Cable Bundle Swivels, 4.5"W (115 mm) and 7"W (178 mm) include (12) Cable Bundle Swivels
- Patented Cable Bundle Swivels provide quick attachment, removal and adjustment of cable bundles
- Select part number per cabinet height and color
- Material: Steel; Cable Bundle Swivels are plastic
- Finish: Black or Glacier White; Cable Bundle Swivels are blue

Cable Lashing Panel for ZetaFrame Cabinet				
Part Number - Panel Width			Height (U)	Shipping Weight lb (kg)
2-3/4 (70 mm)	4.5"W (115 mm)	7.0"W (178 mm)		
38634-X00	38635-X00	38636-X00	42	13 (5.9)
38634-X03	38635-X03	38636-X03	45	14 (6.4)
38634-X06	38635-X06	38636-X06	48	15 (6.8)
38634-X10	38635-X10	38636-X10	52	16 (7.3)
32657-001	Cable Bundle Swivel, Pack of 12			1 (0.5)

Note: X=Color: 7=Black, E=Glacier White. Shipping weights are for 7"W (178 mm) Lashing Panels.



Cable Bundle Swivel, installed

CABLE MANAGEMENT ACCESSORIES



Front-to-Rear Cable Manager

Front-to-Rear Cable Manager attaches to the back of equipment mounting rails wherever there are cable openings, creating a cable pathway between front and rear rails.

- Hooks into front and rear mounting rails, and secures to cabinet frame using supplied hardware
- Adjustable to match various front-to-rear rail depths ranging from 20" (508 mm) to 32" (812 mm)
- Sold each, order to match cabinet width and color
- Material: Steel
- Finish: Black or Glacier White

Front-to-Rear Cable Manager for ZetaFrame Cabinet					
Part Number - Cabinet Width				Rail Depth Range in (mm)	Shipping Weight lb (kg)
23.6"W (600 mm)	27.6"W (700 mm)	29.5"W (750 mm)	31.5"W (800 mm)		
N/A	38648-X01	38648-X02	38648-X03	20-32 (508 - 812)	7 (3.2)

Note: X=Color: 7=Black, E=Glacier White. Shipping weight is for 800 mm configuration

POWER MANAGEMENT ACCESSORIES

Attach eConnect® PDUs to the cabinet.

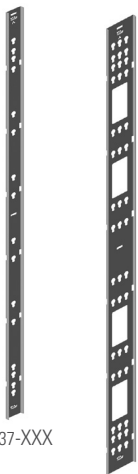

38637-XXX

38638-XXX

Full Height PDU Bracket

- Available in Single or Dual options
- Order per PDU chassis width and PDU bracket capacity (1 or 2 PDUs)
- Bracket attaches to cabinet frame and is adjustable along the cabinet depth
- Use Dual bracket to mount (2) PDUs side-by-side or (1) PDU high outlet density 4" (102 mm) PDU chassis
- Tool-less mounting features at 12-1/4" increments up to 61-1/4" and 64-3/4"
- Select Brackets to match PDU width
- Consider a full height PDU bracket for cabinets 48U and taller for optimum PDU outlet placement

Note: Brackets 38637-X00 to -X10 are 2.48"W (63 mm)
 Brackets 38637-X11 to -X21 are 3.03"W (77 mm)
 Brackets 38638-X00 to -X10 are 4.78"W (121.4 mm)
 Brackets 38638-X11 to -X21 are 5.88"W (149.4 mm)

Full Height PDU Bracket for ZetaFrame Cabinet				
Part Number - PDU Chassis Width			Cabinet Height (U)	PDU Bracket Capacity
2.2" (56 mm)	2.4-2.7" (51 - 69 mm)	4.0" (102 mm)		
38637-X00	38637-X11	38638-X00	42	Single
38637-X03	38637-X14	38638-X03	45	Single
38637-X06	38637-X17	38638-X06	48	Single
38637-X10	38637-X21	38638-X10	52	Single
38638-X00	38638-X11	N/A	42	Double
38638-X03	38638-X14	N/A	45	Double
38638-X06	38638-X17	N/A	48	Double
38638-X10	38638-X21	N/A	52	Double

Note: X=Color: 7=Black, E=Glacier White. Shipping weights are for Dual PDU Brackets

Standard PDU Bracket

- Includes (1) pair of brackets and installation hardware for use with CPI eConnect PDUs or vertical Power Strips. Configure with cabinet or available separately as an accessory.
- Supports (2) 2.7"W (69 mm) or narrower PDUs side-by-side or one PDU up to 4"W (101.6 mm)
- Attaches to the frame in either back corner
- Provides tool-less attachment points spaced 61-1/4" (1556 mm) apart on all cabinets
- Provides alternate tool-less attachment points spaced 64-3/4" (1645 mm) on cabinets 45U or taller

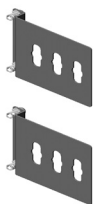

Standard PDU Bracket for ZetaFrame Cabinet		
Part Number	Description	Shipping Weight lb (kg)
38645-700	2-Piece, Black	2 (0.9)

Service Parts

Service parts include mounting rails, top panels, side panels, doors and door lock kits and are used as replacement parts or to upgrade cabinets as applications change.

The ZetaFrame Service Parts Cut Sheet is available for download at chatsworth.com or contact CPI Technical Support at 800-834-4969 or techsupport@chatsworth.com for assistance.

For complete ZetaFrame information, visit chatsworth.com.



CPI now offers Extended Limited Warranties on CPI-Branded Electronic products, available for two additional years beyond the expiration of the Original Warranty Period (3 years).

Contact CPI Customer Service, or visit chatsworth.com/warranty for more information.