

ASSEMBLY INSTRUCTION

DINING CHAIRS 2

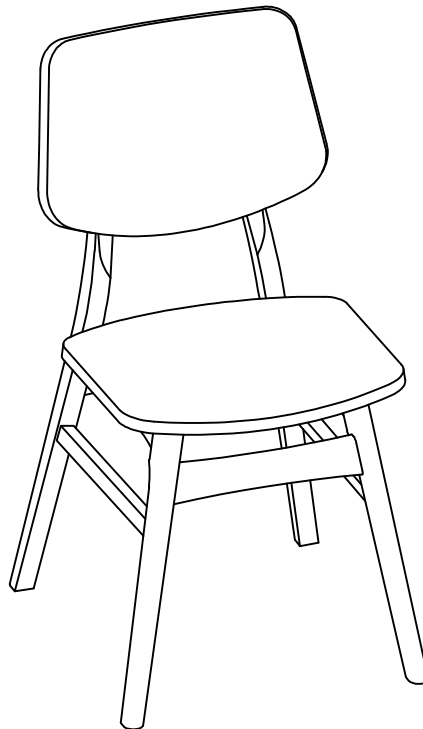

REPLACEMENT PARTS

Please do not contact the company purchased from as we can help you faster.
Order replacement parts and hardware at "www.boltonfurniture.com"

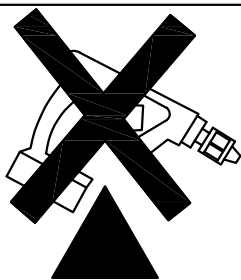

- . Use of power tool to assemble this product will invalidate any claim and damage this product making it unsafe !!!
- . Please assemble on a clean soft surface to avoid damage.

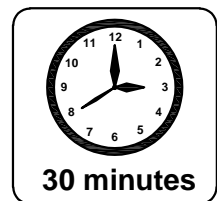
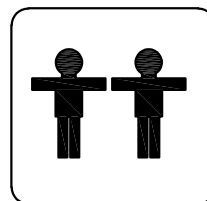

Tools Required

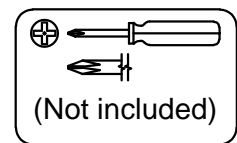
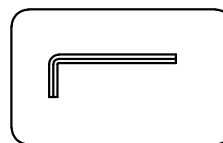

www.boltonfurniture.com

Part list - Dining Chairs 2

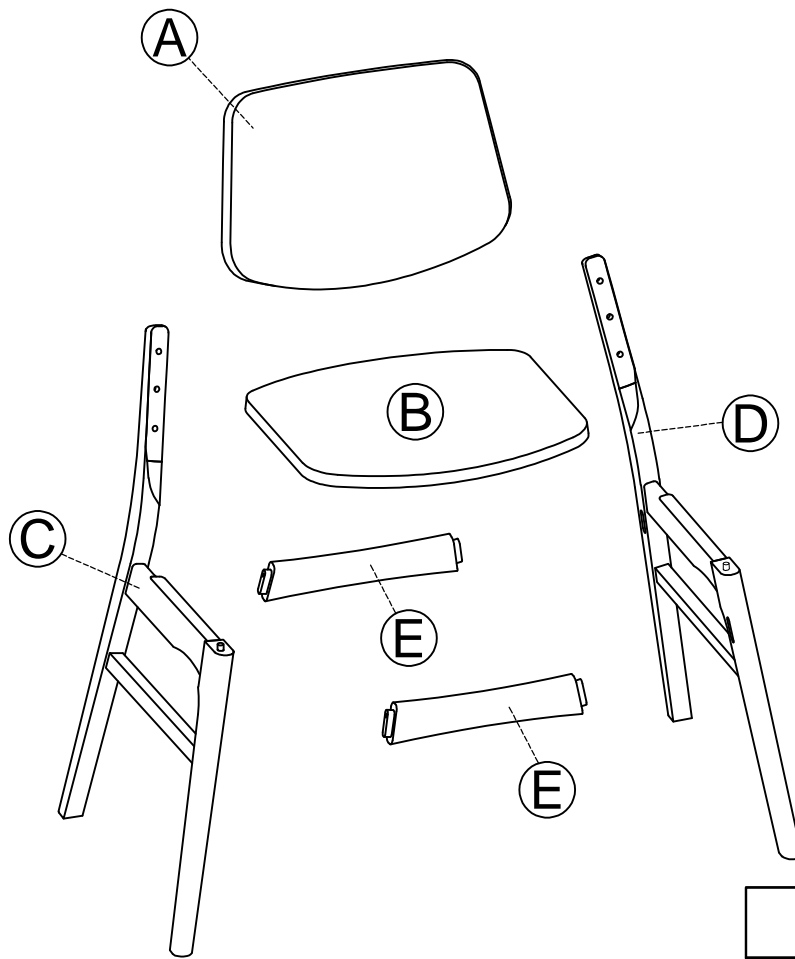



QTY			
(A)	1	(B)	1
(C)	1	(D)	1
(E)	2		

Identifying the hardware-Identify the hardware using the illustrations below



1
4
 M6 x 30MM BOLT



2
4
 Metal bracket

3
2
 Ø8 x 30 DOWEL

4
4
 Wood plug



5
16
 M4 X 15 SCREW



6
4
 M4 X 50 SCREW



7
1
 ALLEN KEY

ASSEMBLY DESCRIPTION

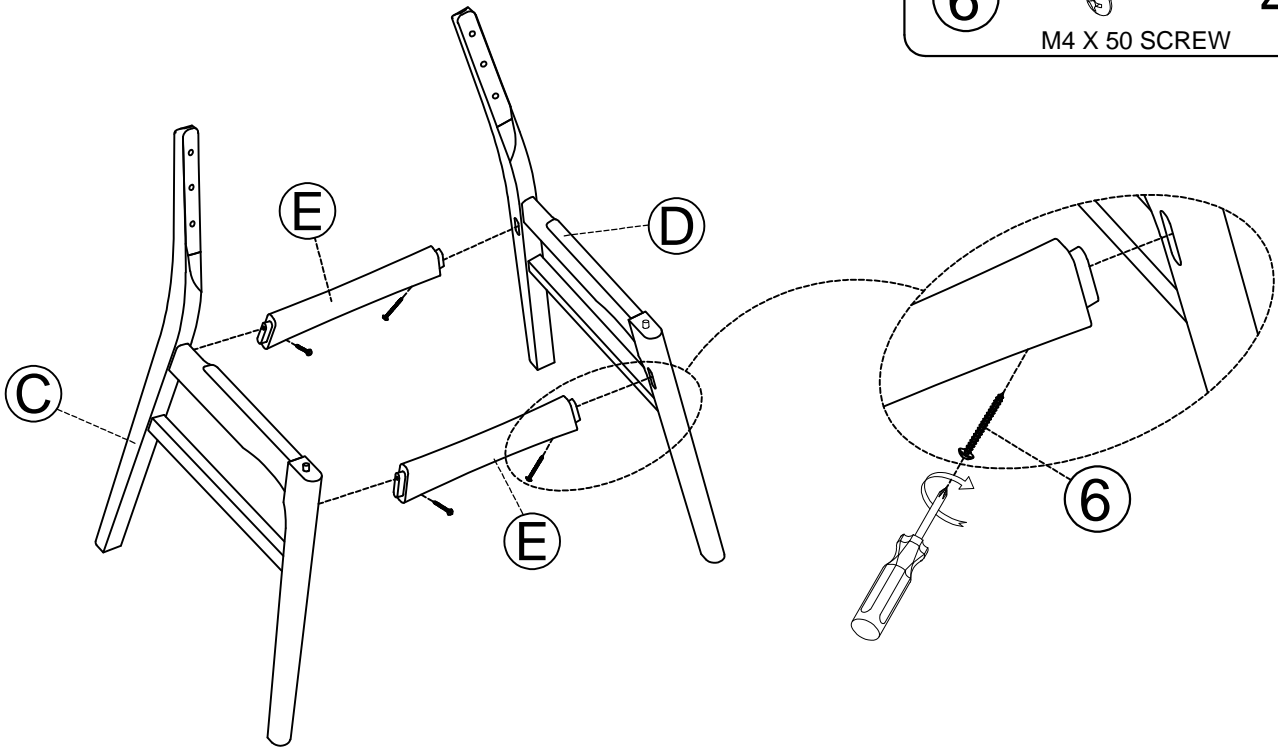
STEP 1

6

4
 M4 X 50 SCREW



1

4
 M6 x 30MM BOLT

3

2
 Ø8 x 30 DOWEL

4

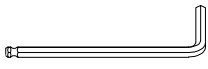
4
 Wood plug

STEP 2

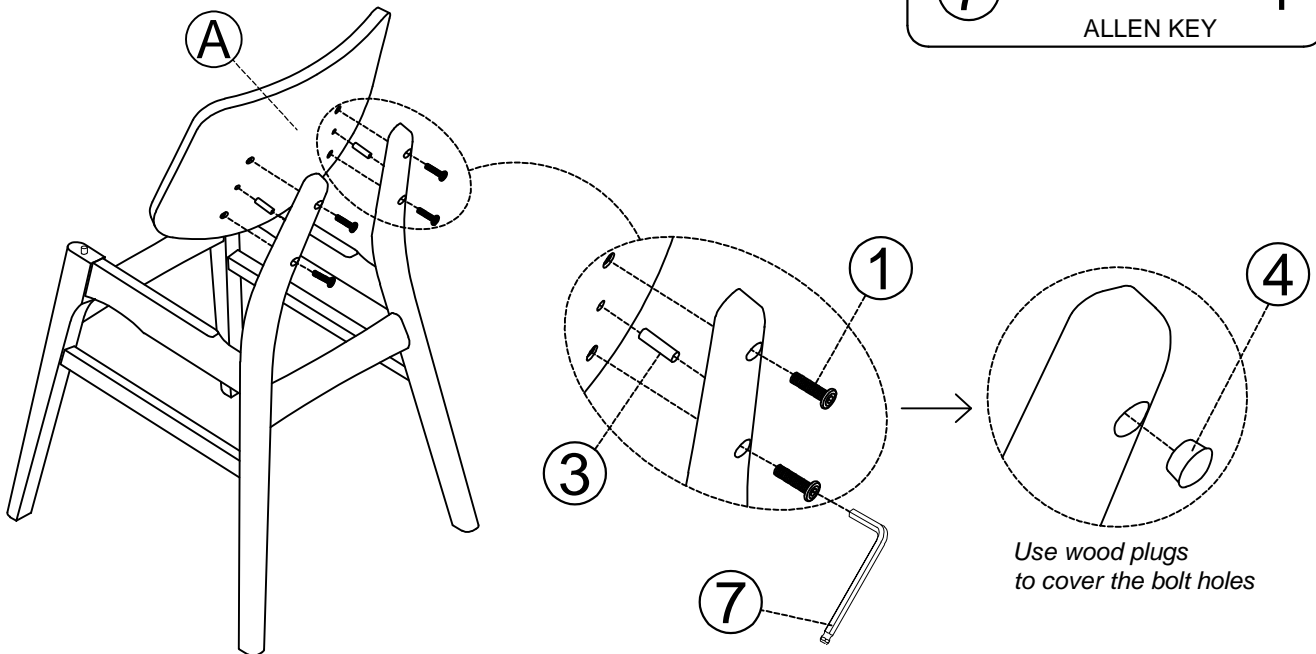
7

1
 ALLEN KEY



ASSEMBLY DESCRIPTION

STEP 3

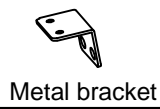
2



4

5



16

