

# 2101579 BEAUMONT PERGOLA 20x12 Container Loading Diagram

( 1 set=4 boxes, 55 sets/40HQ, 20 pallets/ 40HQ, Gross weight: 18545kg)

Top view

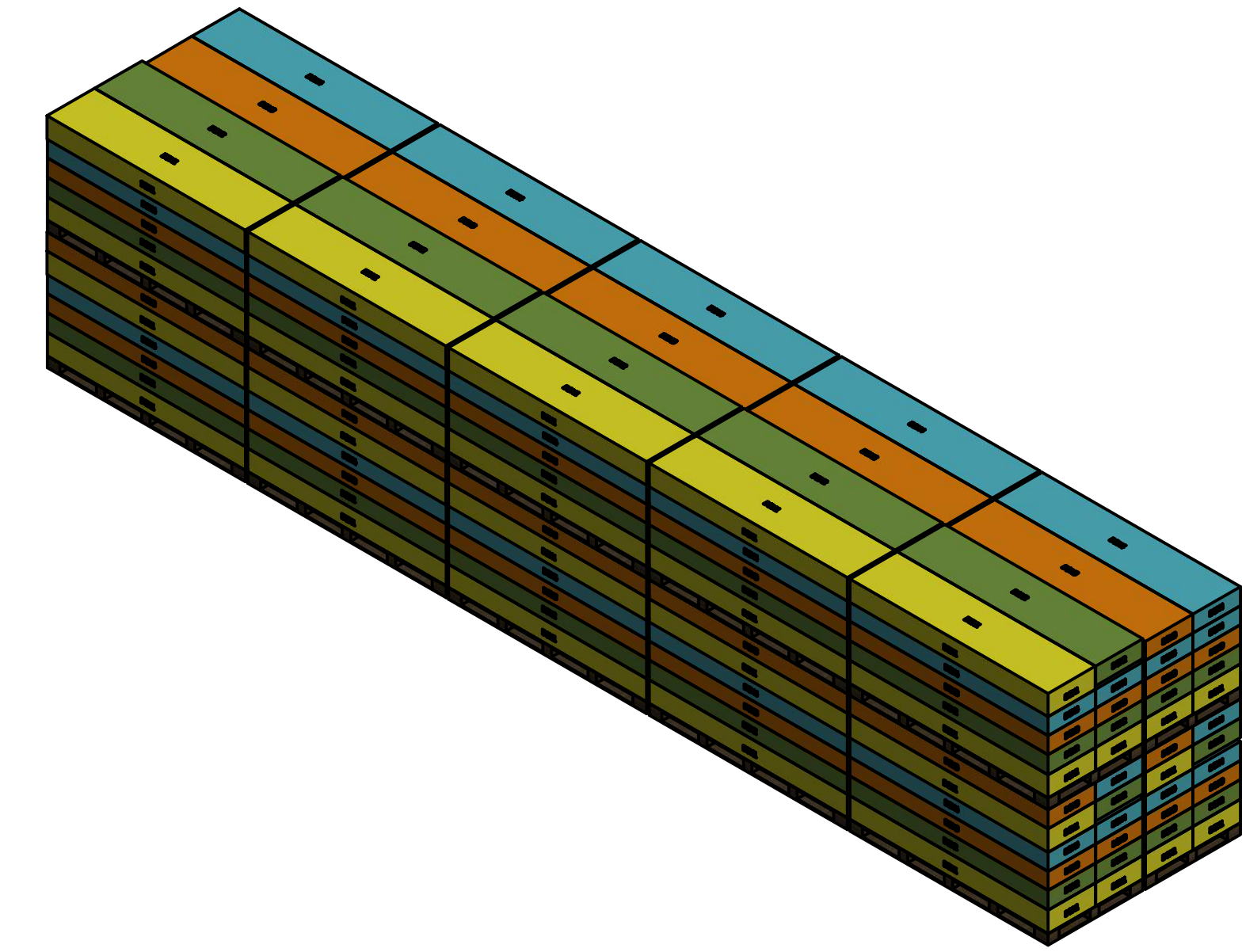
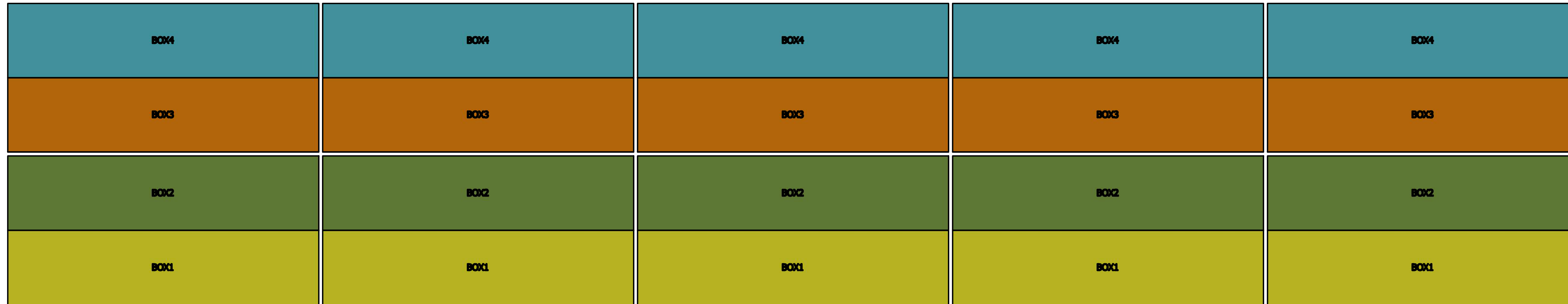

End view

Side view

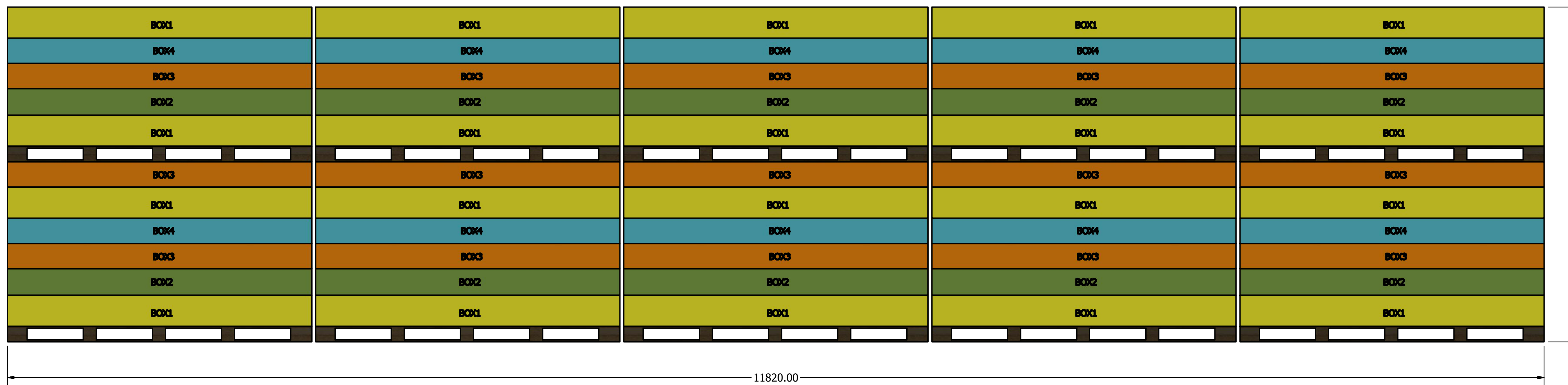

Pallet B \* 5

Pallet C \* 5

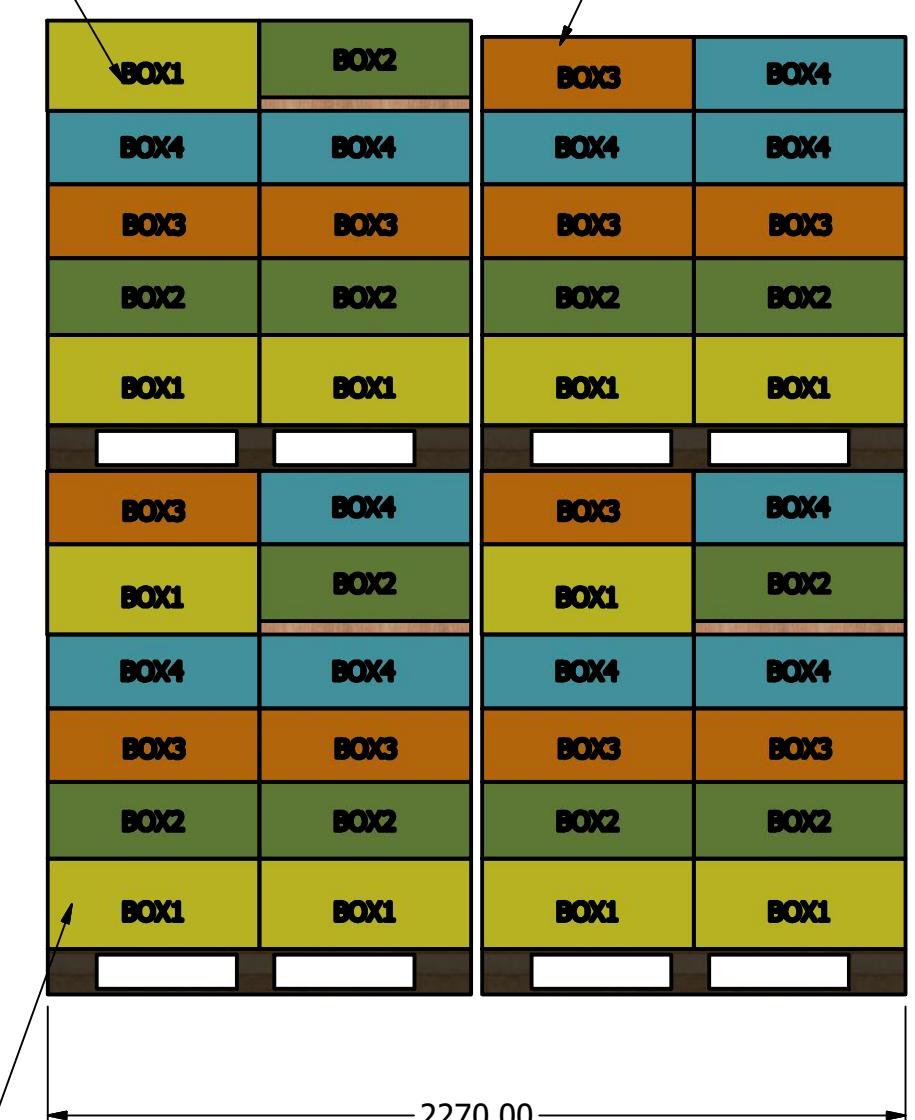

Pallet A \* 10

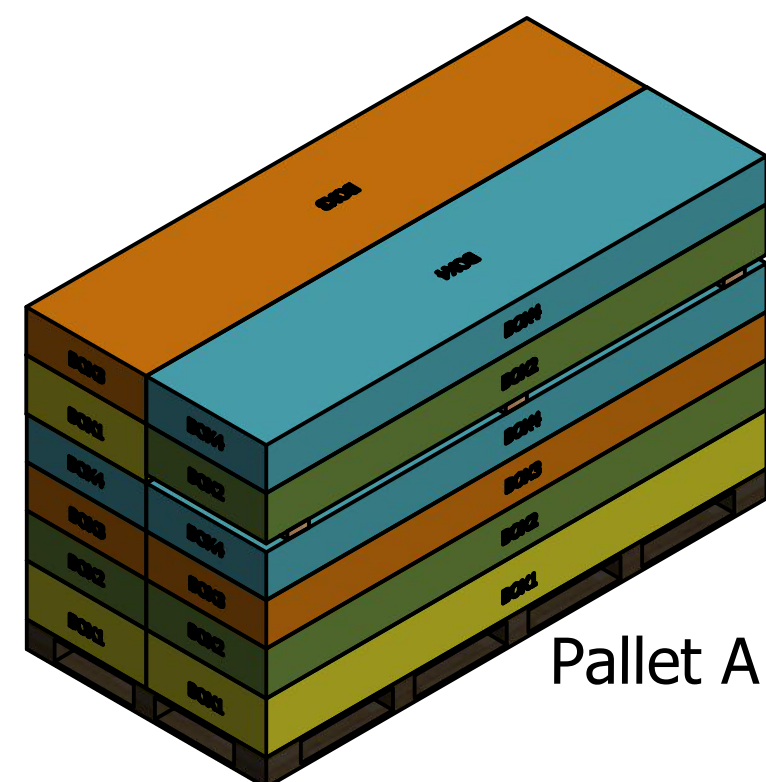

Pallet A (3 sets/Pallet)

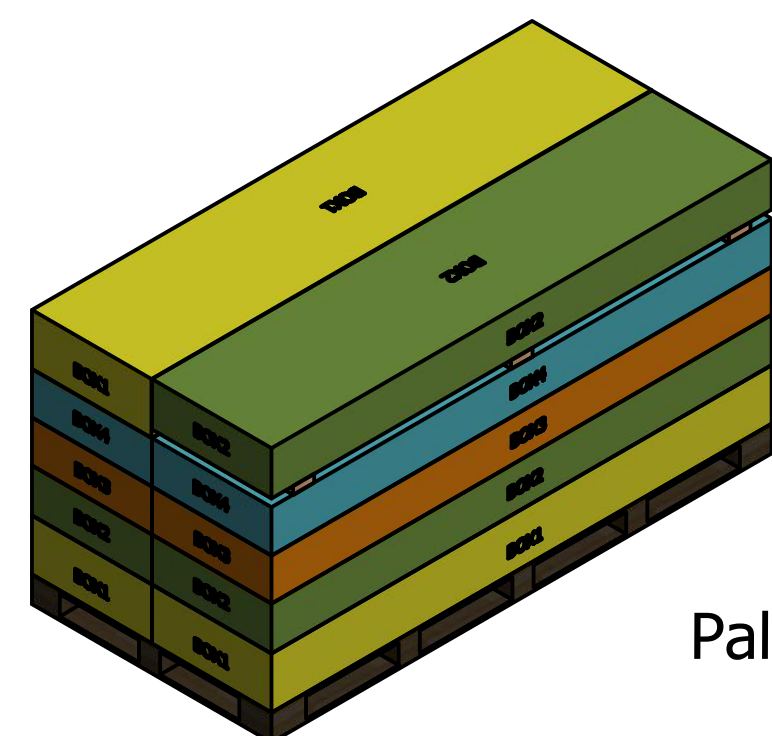

Pallet B (2.5 sets/Pallet)

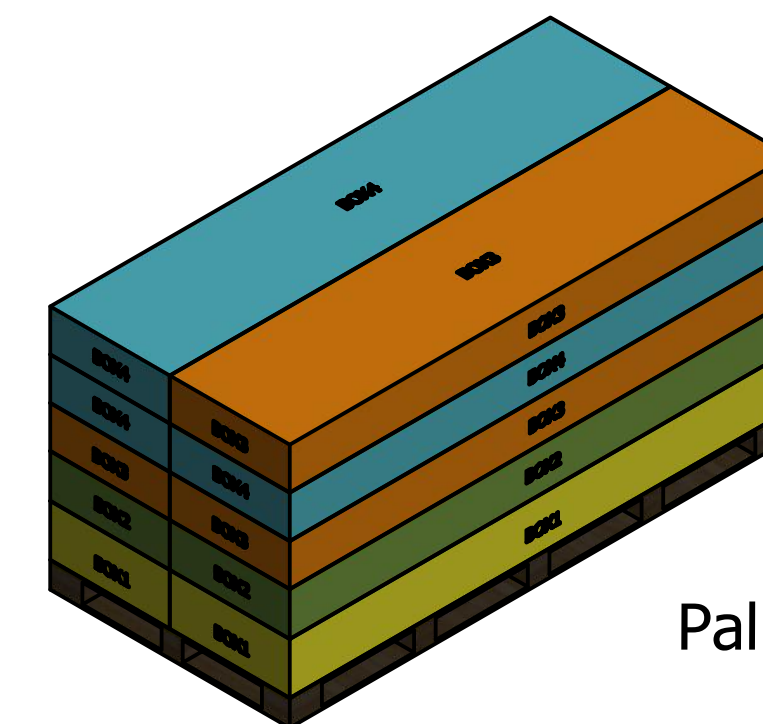

Pallet C (2.5 sets/Pallet)

DRAWN Rudy		TITLE	
CHECKED			
QA			
MFG			
APPROVED			
		SIZE D	DWG NO
		SCALE 0.04	REV
		SHEET 1 OF 1	

# Pallet A detail (3 sets)

Top View

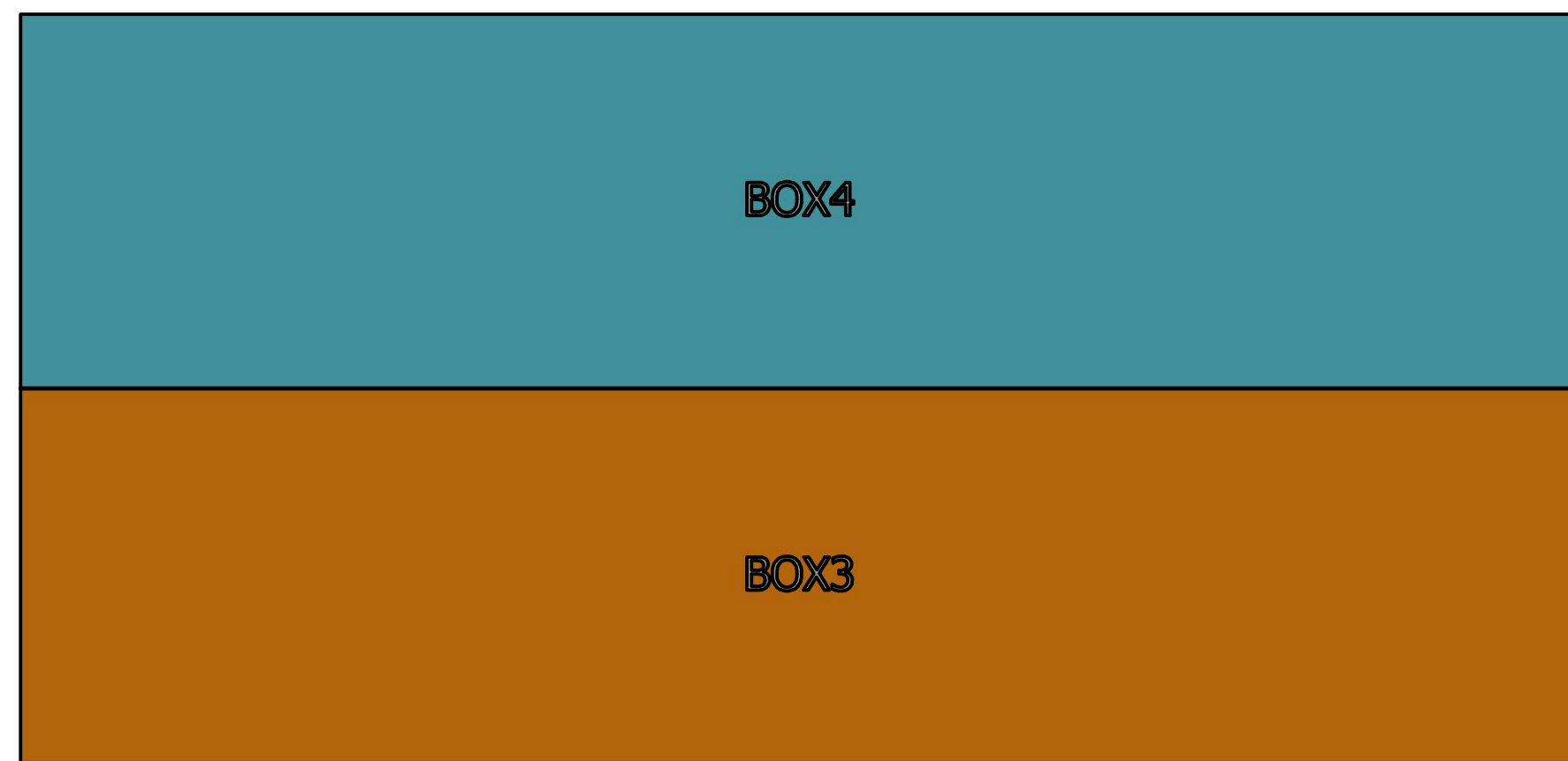

Wood Block \*3 (550mm\*100mm\*36mm)

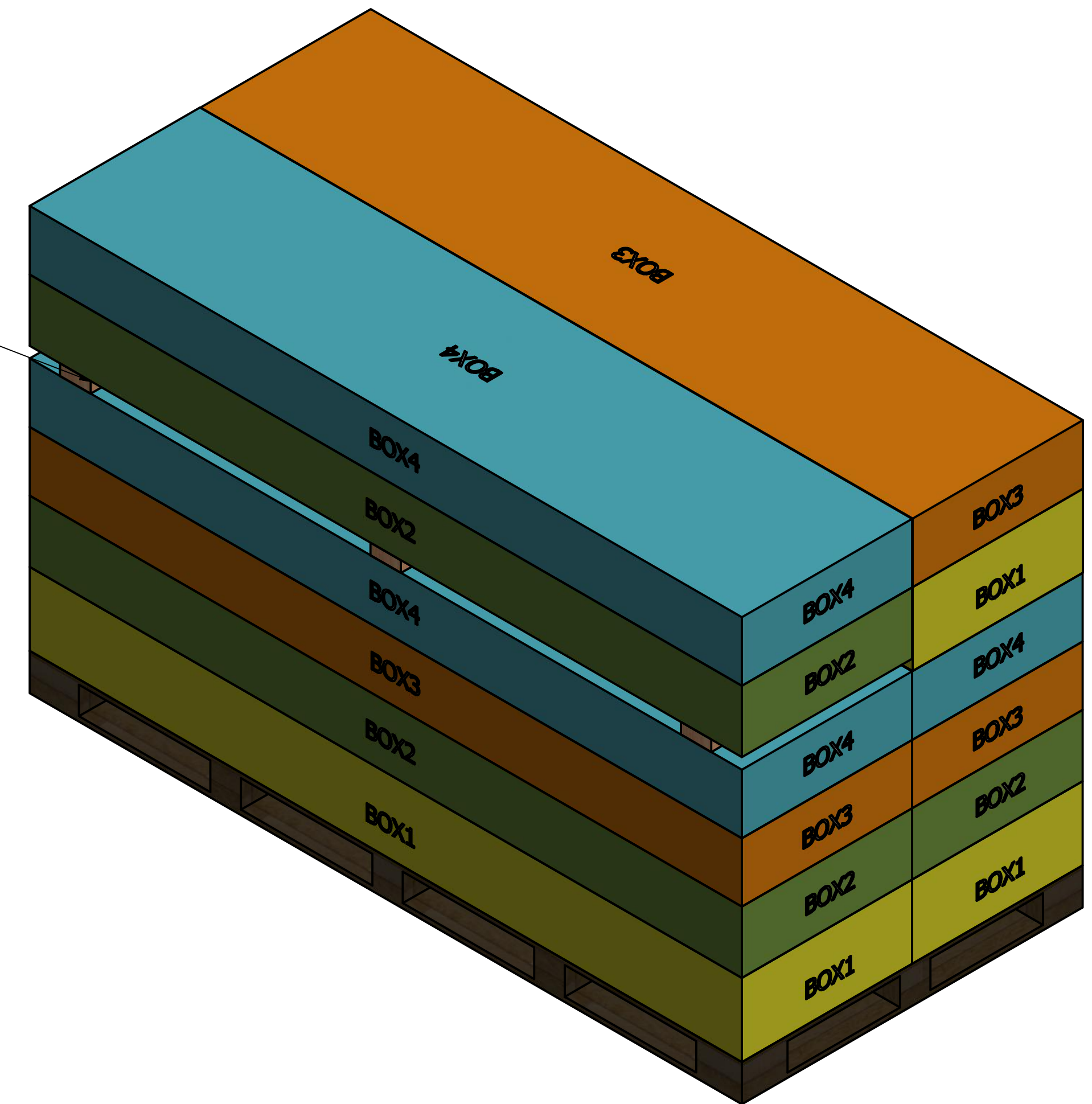

Side View

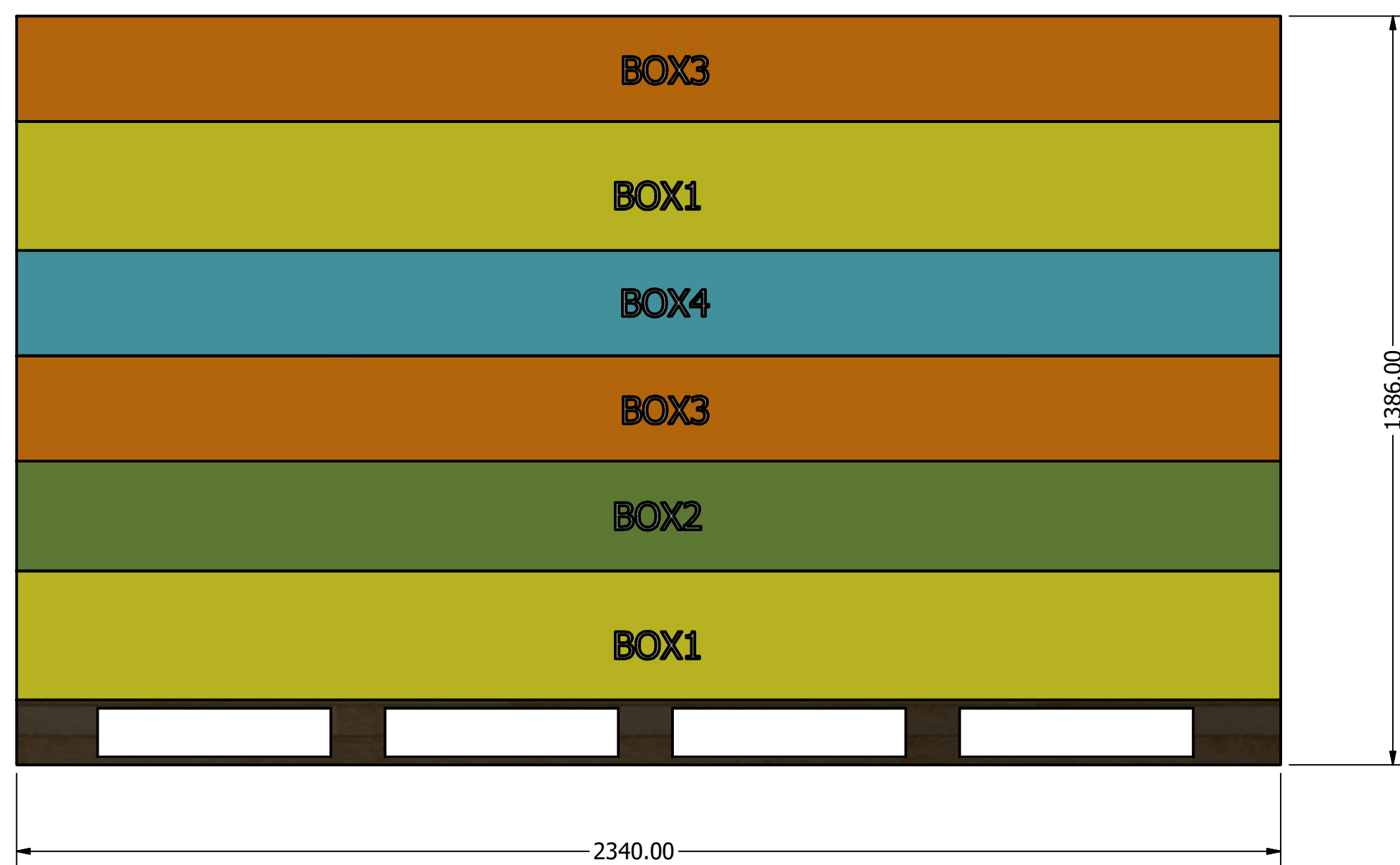

End View

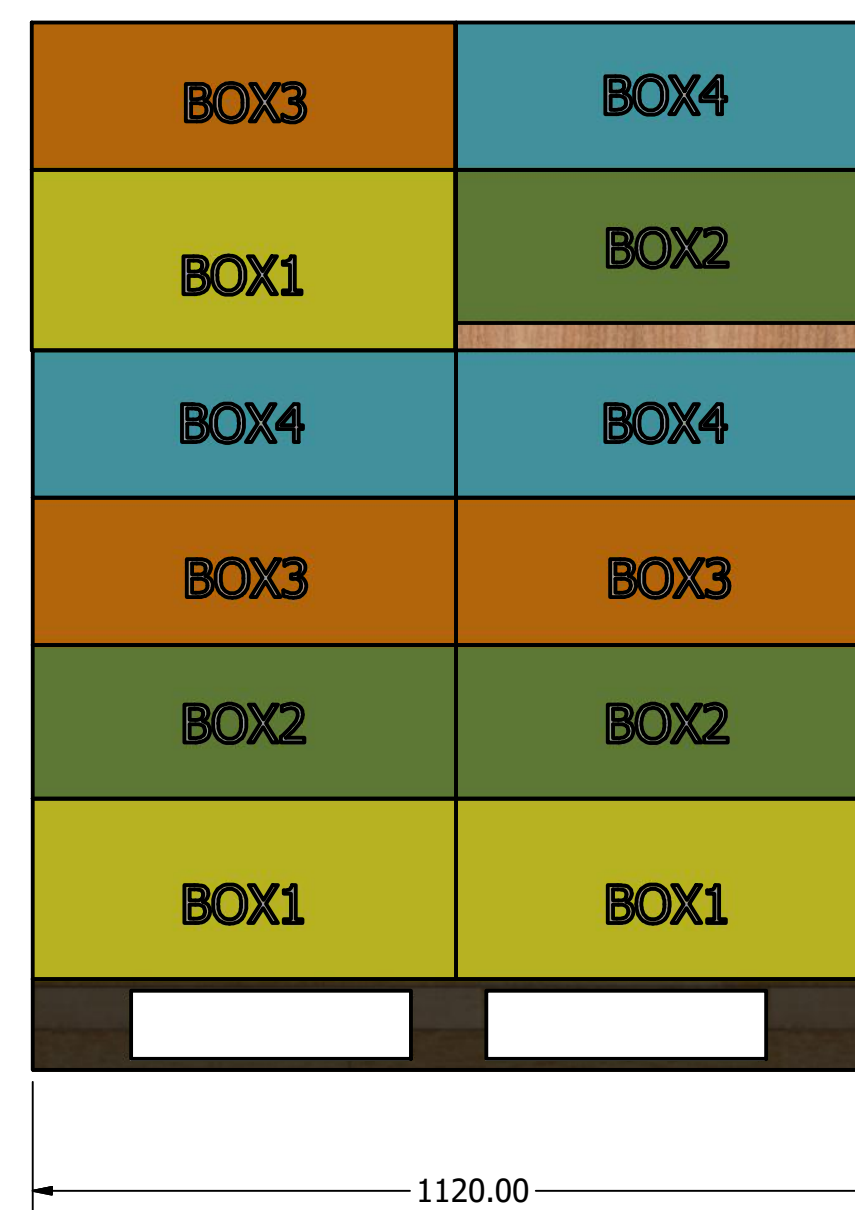

DRAWN Rudy			
CHECKED		TITLE	
QA			
MFG			
APPROVED			
		SIZE D	DWG NO Pallet A
		SCALE 0.1 : 1	REV
		SHEET 1 OF 1	

# Pallet B detail (2.5 sets)

Top View



Wood Block \*3 (550mm\*100mm\*36mm)

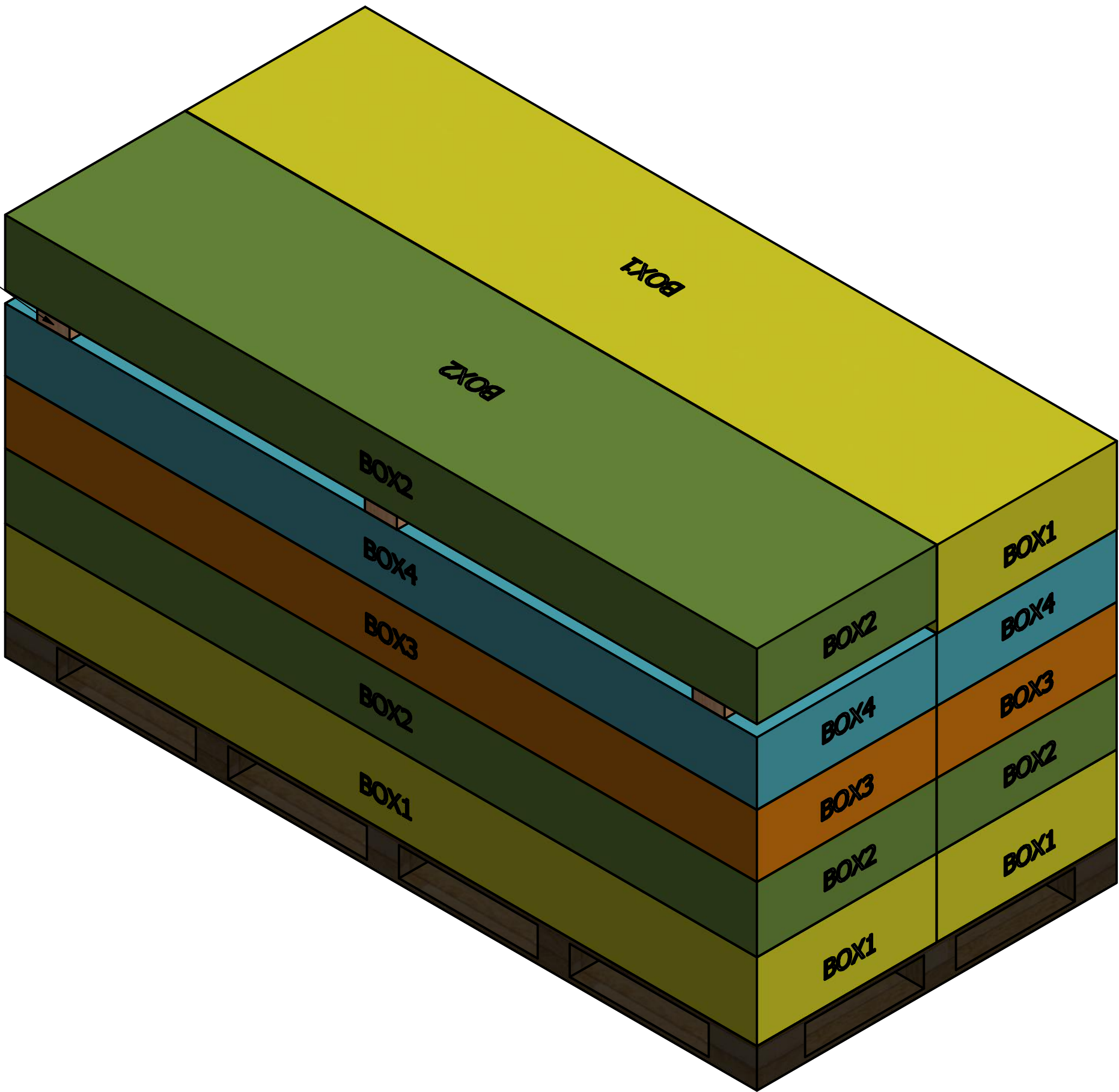

Side View

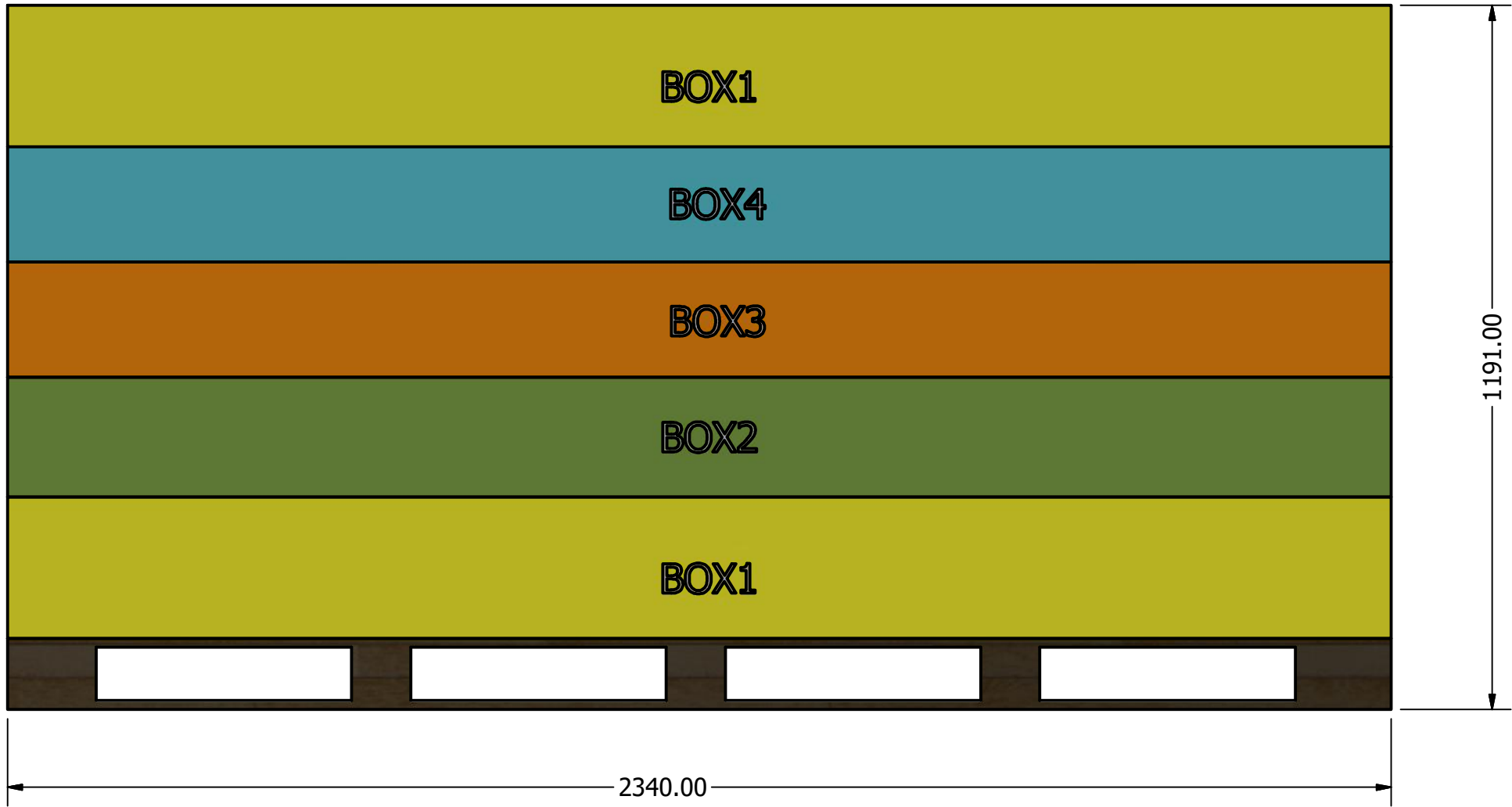

End View

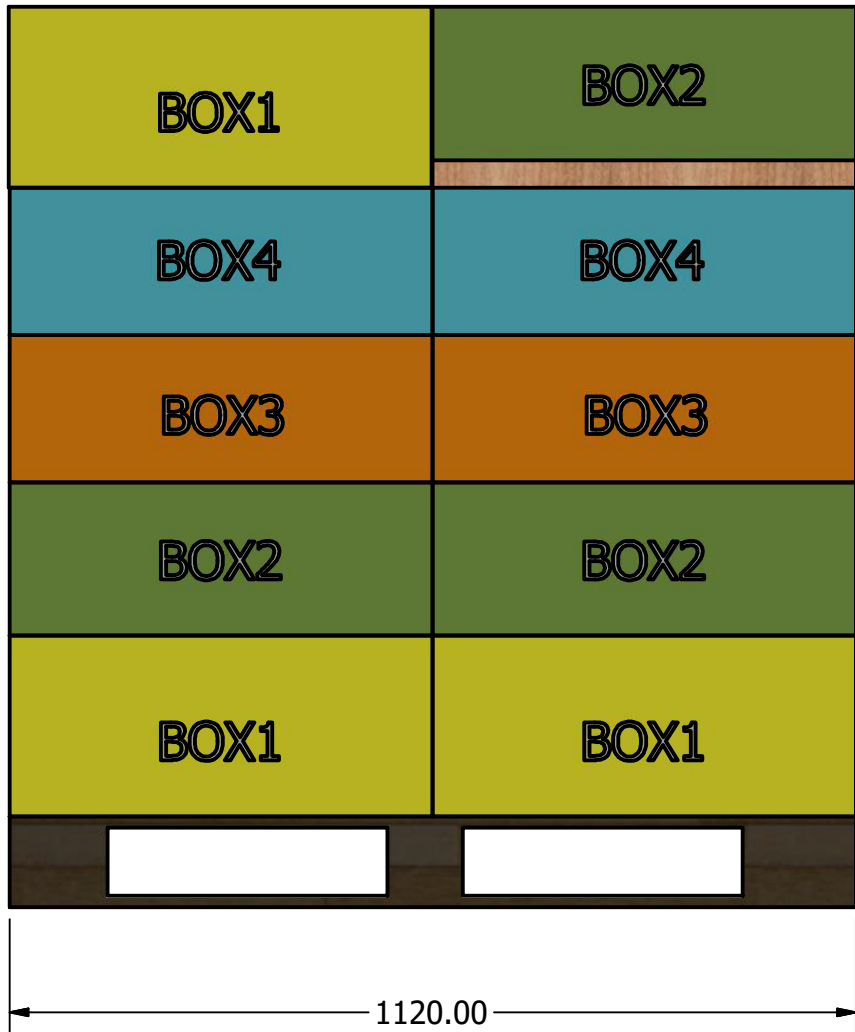

DRAWN Rudy		TITLE	
CHECKED			
QA			
MFG			
APPROVED			
		SIZE D	DWG NO Pallet B
		SCALE 0.1 : 1	REV
		SHEET 1 OF 1	

# Pallet C detail (2.5 sets)

Top View

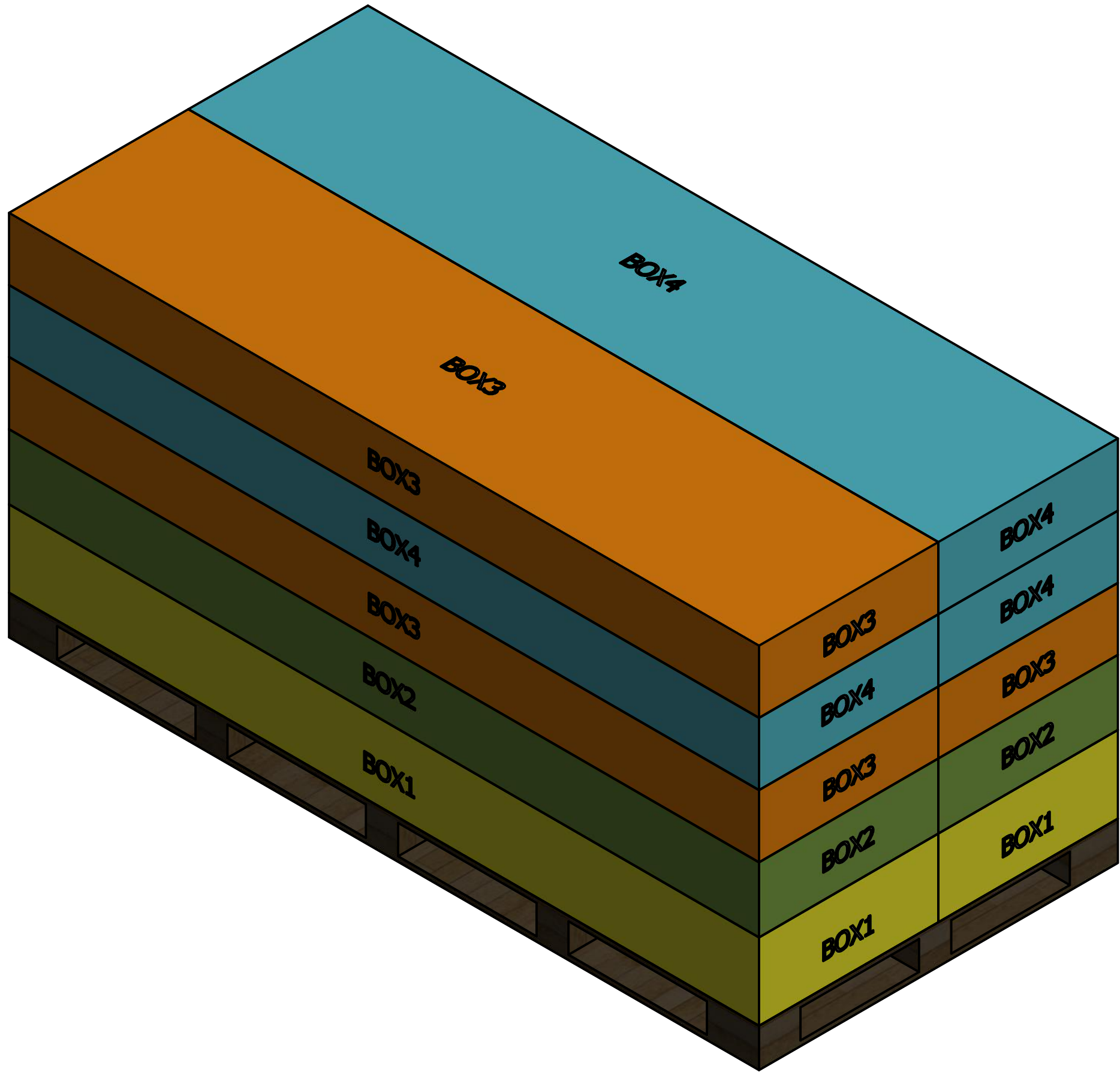
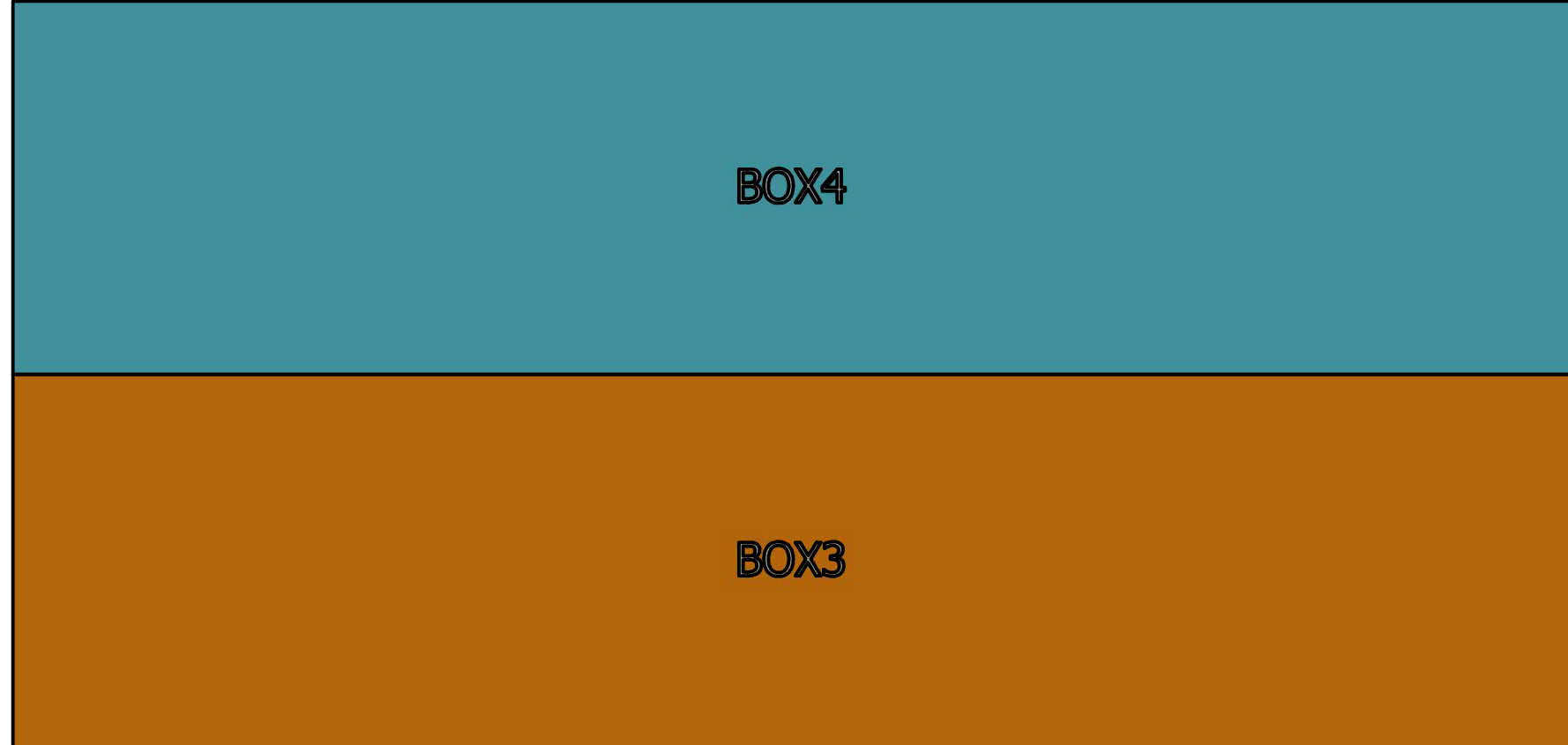

Side View

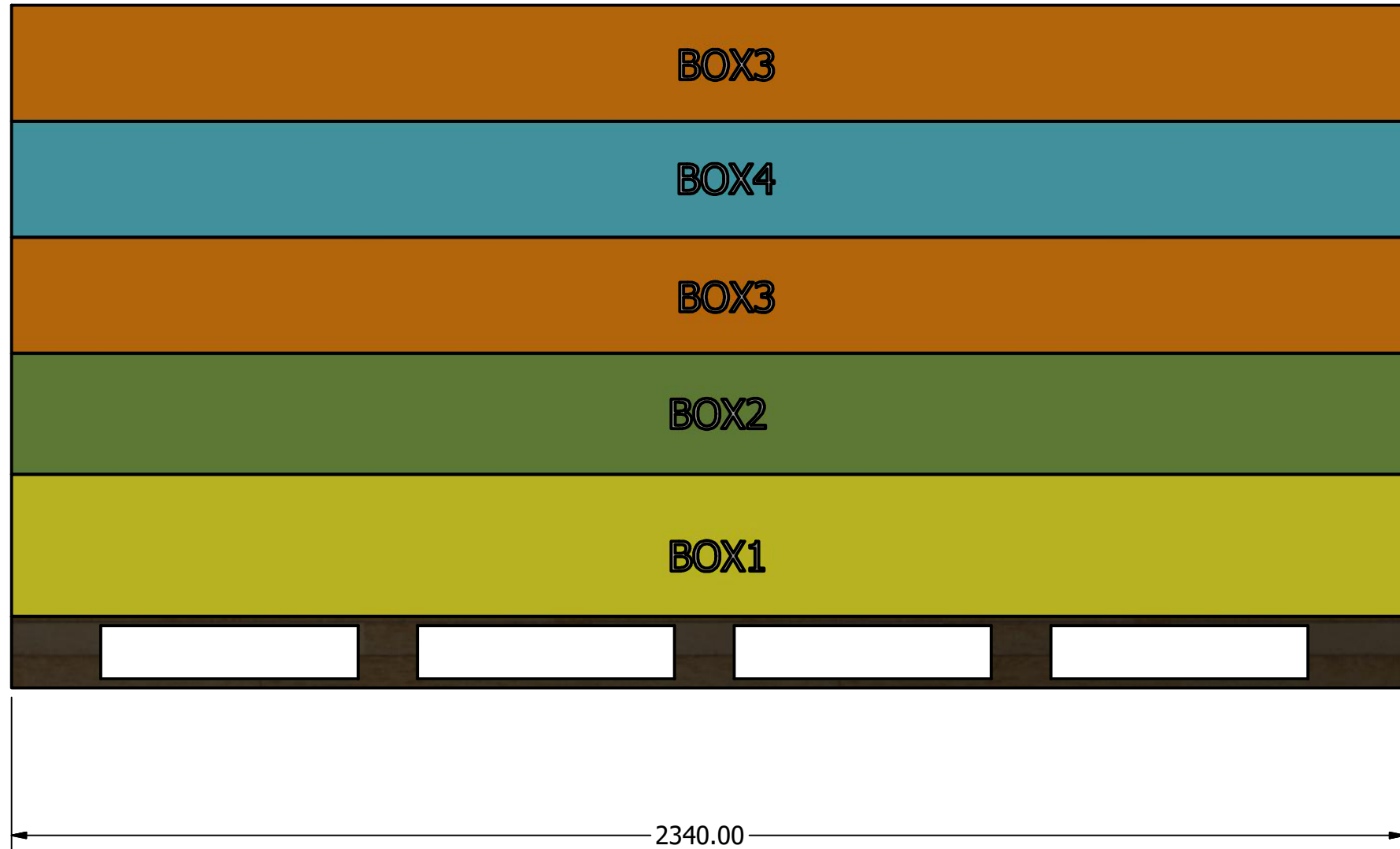

End View

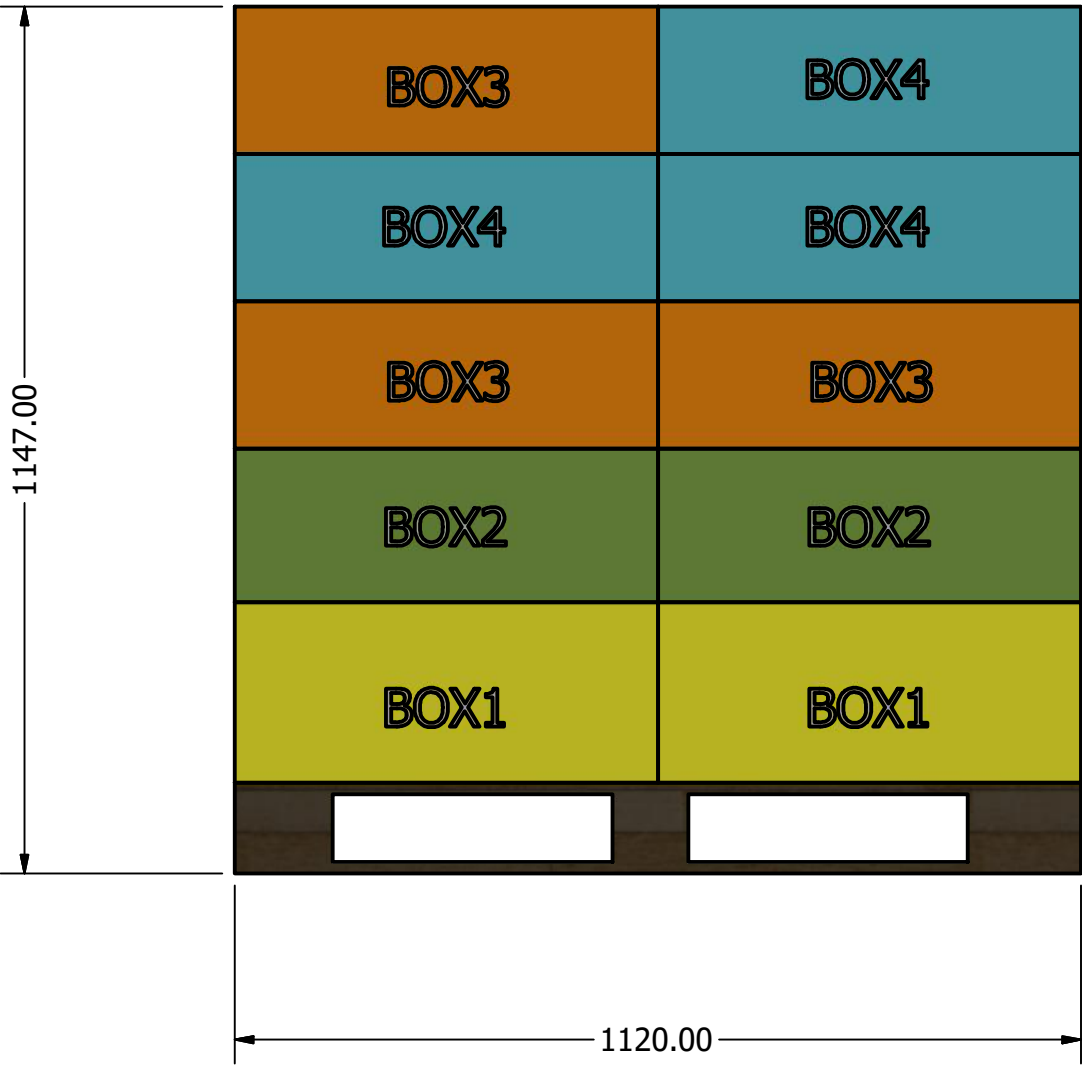

DRAWN Rudy		TITLE		
CHECKED				
QA				
MFG				
APPROVED		SIZE D	DWG NO Pallet C	REV
		SCALE 0.1 : 1	SHEET 1 OF 1	

BOX1 (79KG)

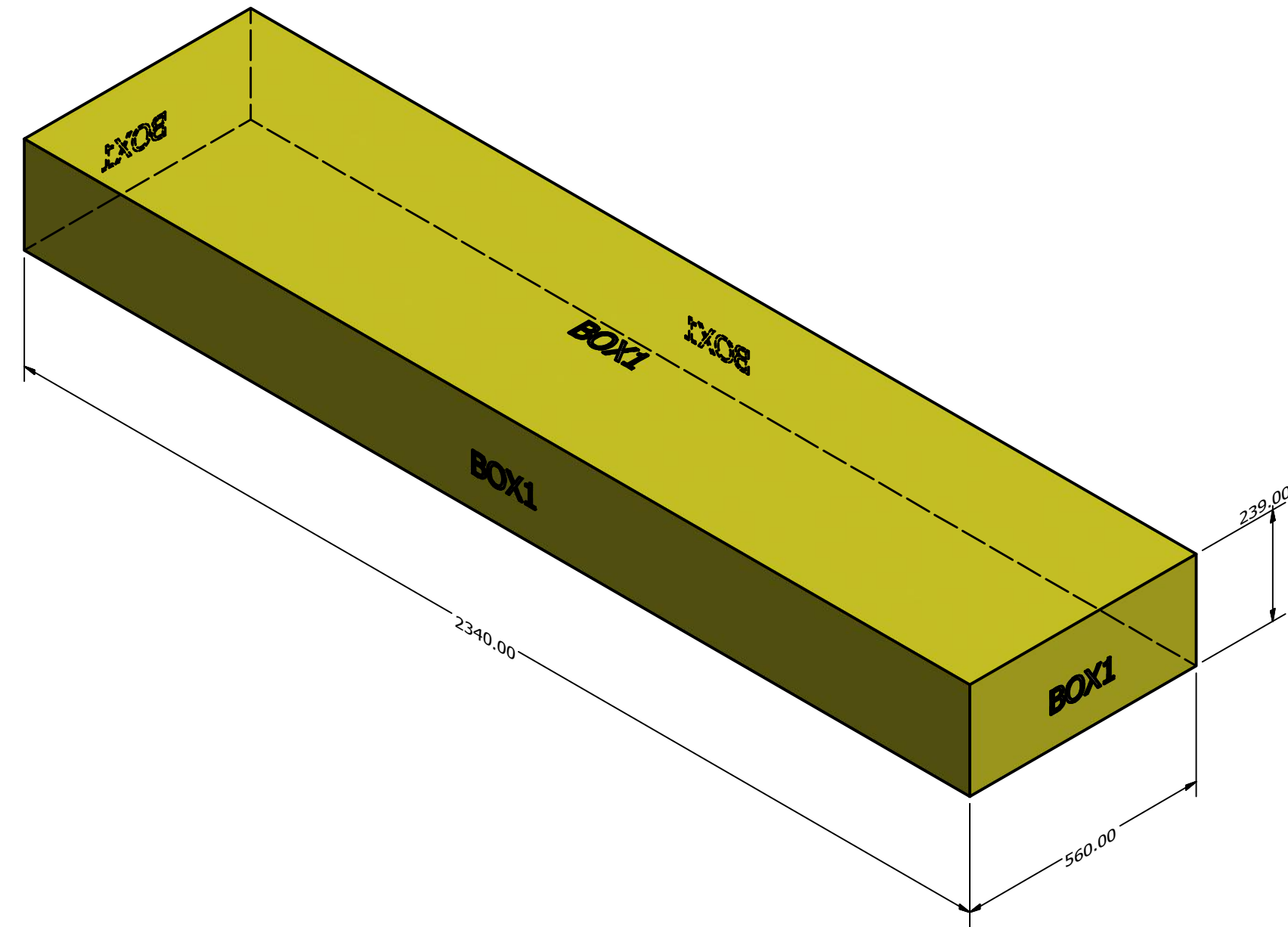

BOX2 (75KG)

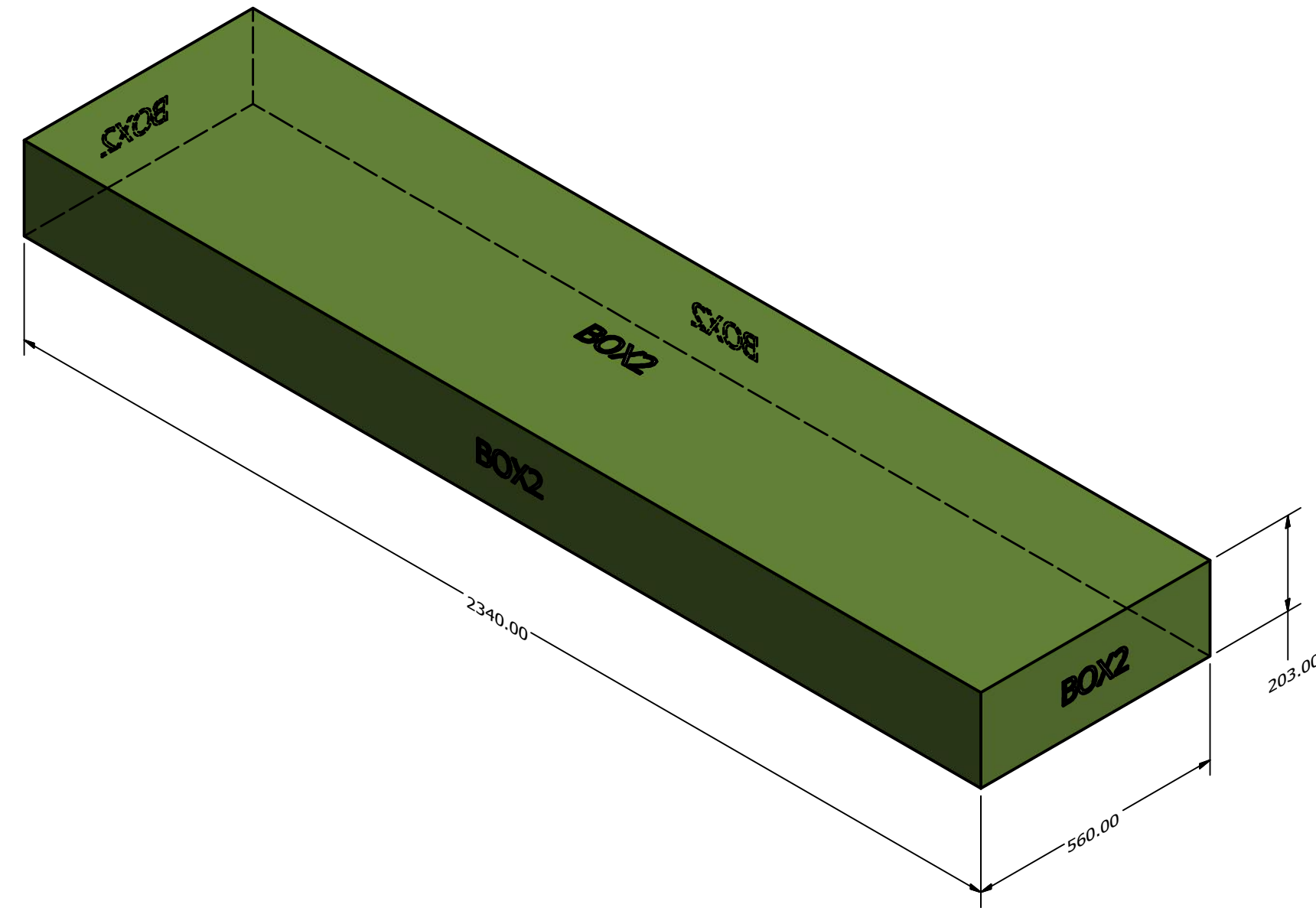

BOX3 (77KG)

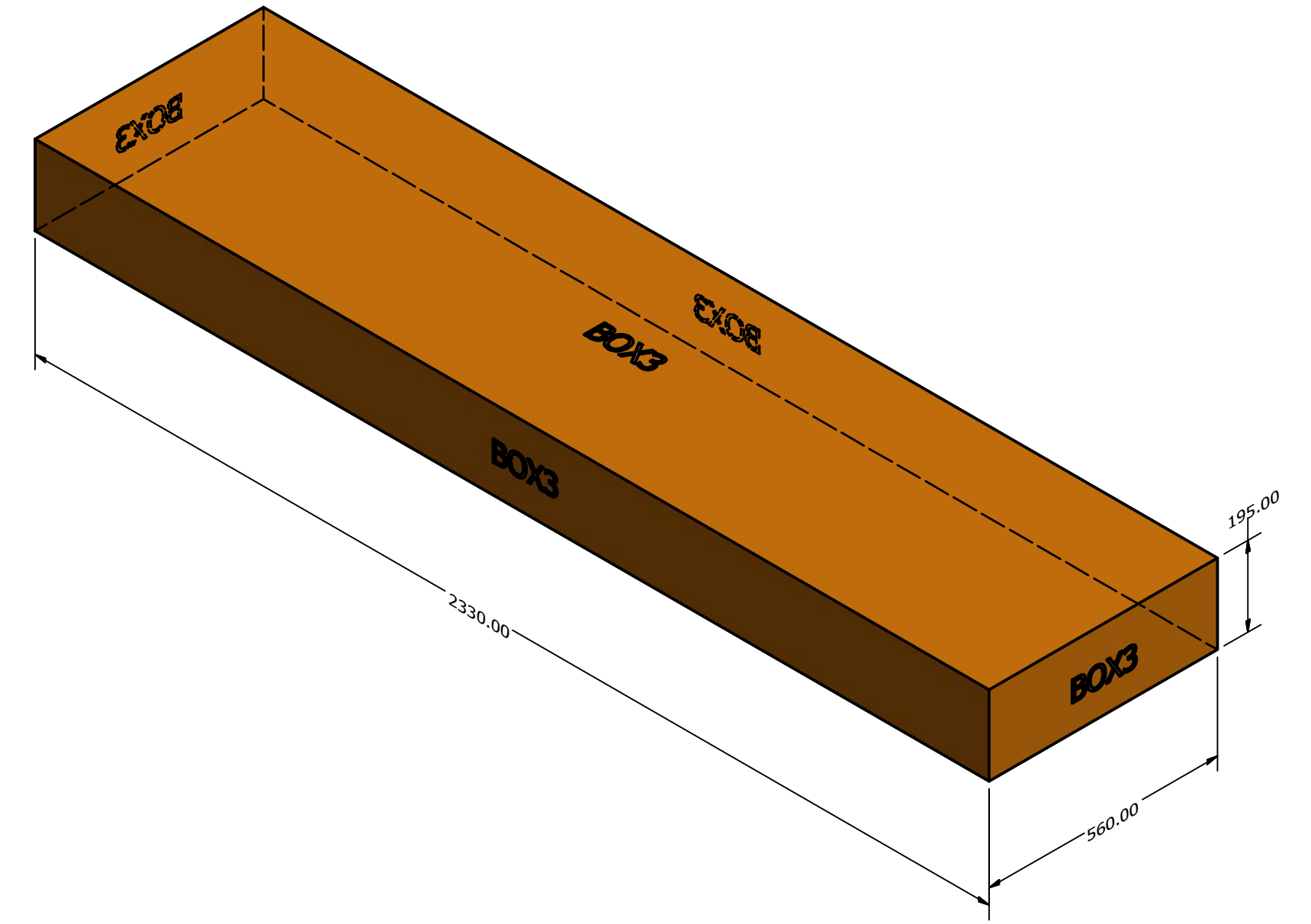

BOX4(88KG)

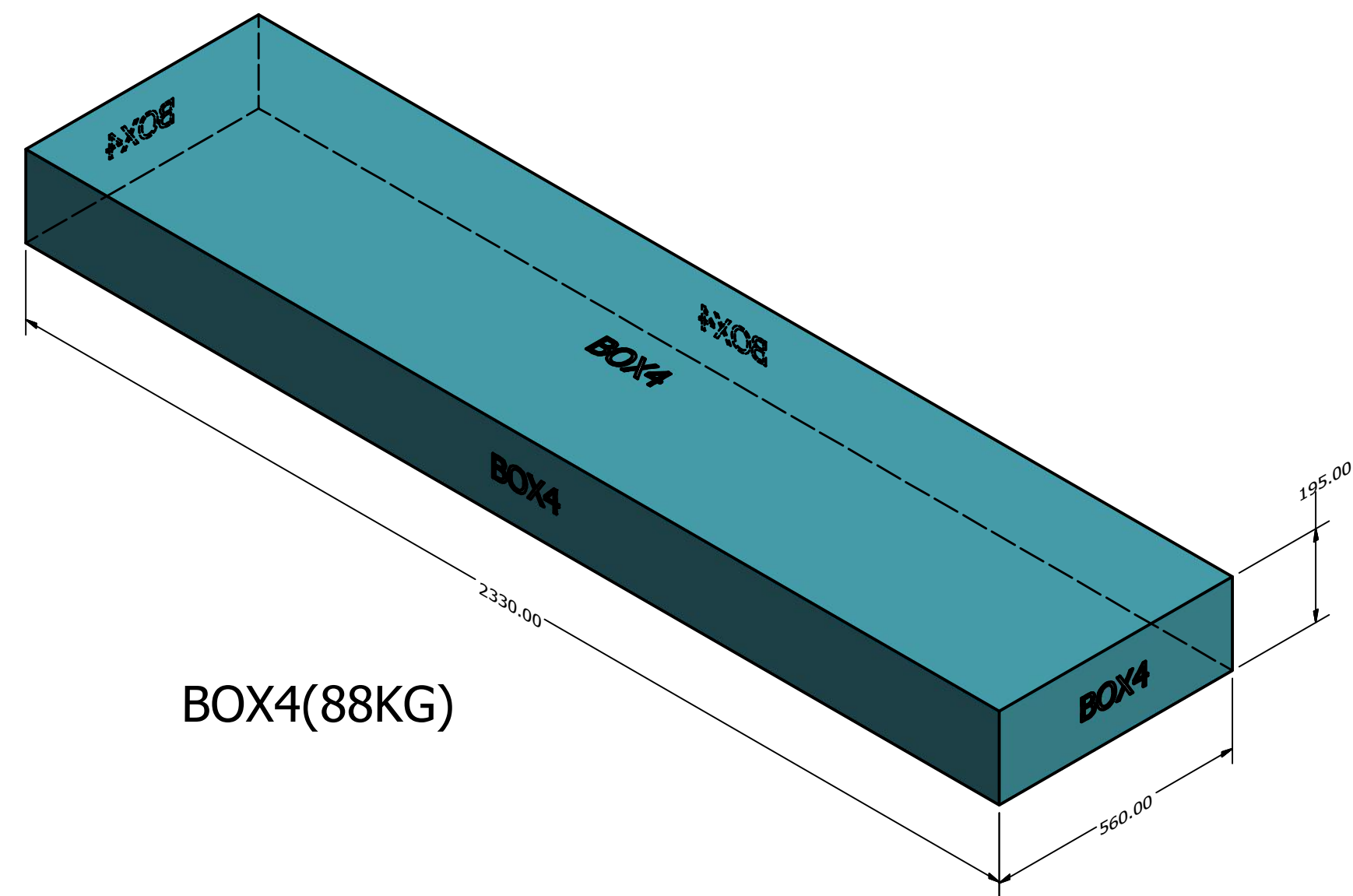

DRAWN	Rudy	2019-11-13			
CHECKED			TITLE		
QA					
MFG					
APPROVED					
			SIZE	DWG NO	REV
			D	BOXES	
			SCALE	0.10	SHEET 1 OF 1