



Underscore® | K-1174-JH

72" x 42" drop-in heated whirlpool bath

Features

- Eight Proflex® hydromassage jets can be individually adjusted for water flow and direction
- Single-speed whirlpool offers performance and value with 8 fully adjustable jets
- Built-in heater
- Slotted overflow allows for deep soaking
- Spacious design accommodates up to two bathers
- Integral lumbar support
- Textured bottom surface



Available Colors/Finishes

Color tiles intended for reference only.

- 0 White
- 96 Biscuit
- 95 Ice Grey
- 7 Black Black



1-800-4KOHLER (1-800-456-4537)
Kohler Co. reserves the right to make revisions without notice to product specifications.
For the most current specification sheet, go to www.kohler.com USA or www.kohler.ca Canada.
5-12-2026 18:9 - US-CA

THE BOLD LOOK
OF **KOHLER**

Codes/Standards

ASME A112.19.7/CSA B45.10
 CSA B45.5/IAPMO Z124
 ASTM E162
 ASTM E662
 UL 1795
 CSA C22.2 No. 218.2
 cUL Listed
 UL Listed

Technical Information

All product dimensions are nominal.

Drain Location:	Center
Drain Hole Diameter:	3-3/8" (85 mm)
Minimum Flat for Door:	2-7/16" (61 mm)
Basin Area, Bottom:	45-3/4" x 32" (1162 mm x 813 mm)
Basin Area, Top:	66" x 36" (1676 mm x 914 mm)
Water Depth:	19" (483 mm)
Water Capacity:	100.4 gal (380.1 L)
Minimum Floor Load:	63 lbs/ft ²
Weight:	130 lbs (59 kg)
Cutout:	Drop-in, 70-1/2" x 40-1/2" (1791 mm x 1029 mm)

Material

- Acrylic

Recommended Products/Accessories

K-1491 Bath/whirlpool pillow, removable
 K-1601 Bath/whirlpool footstop, removable

Required Products/Accessories

- K-7271 Slotted overflow brass bath drain
- or
- K-7272 Slotted overflow bath drain

Required Electrical Service

Two dedicated circuits required, protected with Class A Ground-Fault Circuit-Interrupter (GFCI). Outside North America, this device may be known as a Residual Current Device (RCD).

Pump:	120 V, 15 A, 60 Hz
Heater:	120 V, 12 A, 60 Hz

Electrical Component Ratings

Pump:	120 V, 7 A, 60 Hz
Heater:	120 V, 12 A, 60 Hz

Warranty

See website for detailed warranty information.

KOHLER® Plastic Baths and Shower Bases Lifetime Limited Warranty|KOHLER® Hydrotherapy Components Five-Year Limited Warranty



No change in measurements if connected with drain illustrated. (K-7272)

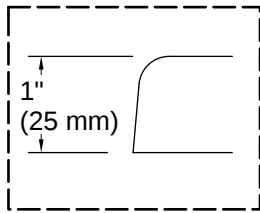

Drop-in Rim Detail

Blower Motor Access
20" (508 mm) W x 15" (381 mm) H Min

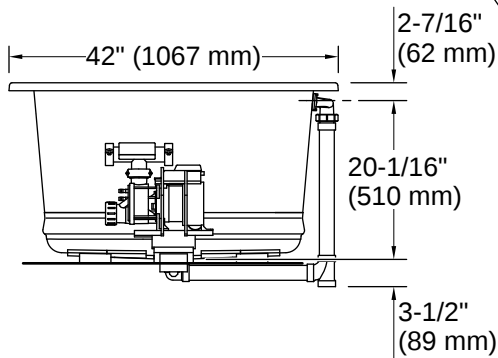
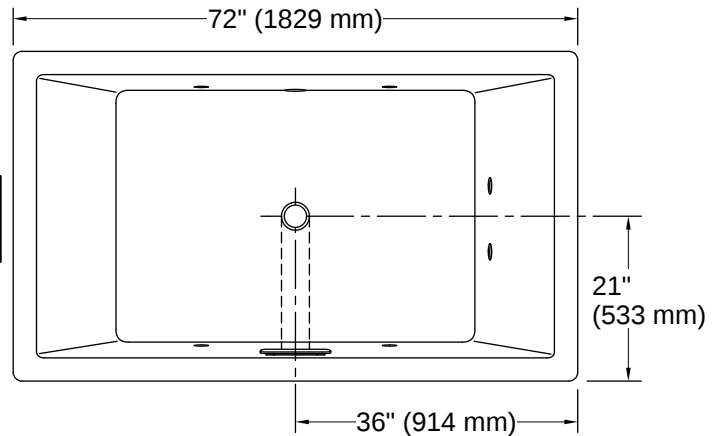

Lumbar Angle 33°

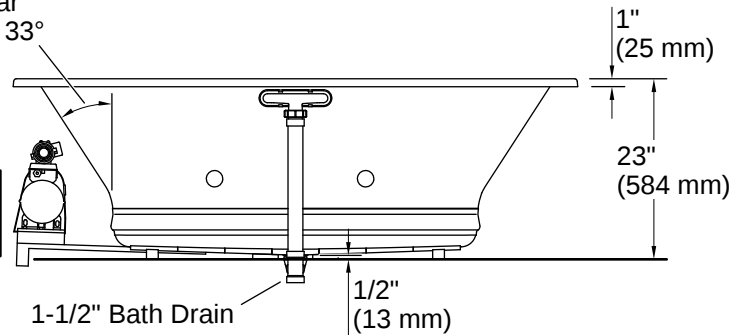

Installation

- Drop-in or undermount
- Center drain
- Requires Clearflo slotted overflow bath drain (sold separately)

Installation Notes

Install this product according to the installation instructions.

Measure your actual product for rough-in details.

The hot water supply should be 70% of the capacity of the bath or greater. Installations will vary.

