

## Features

- A single handle controls both on/off activation and temperature setting
- ADA-compliant ergonomic handle
- Coordinates with other products in the Riff collection

## Material

- Premium material construction with metal handle ensures reliability and durability
- KOHLER finishes resist corrosion and tarnishing

## Installation

- Wall-mount

## Required Products/Accessories

K-8304 Series Rite-Temp® Valve & Cartridge Kits

or

K-8300 Series Rite-Temp® Valve Body Rough-ins

K-8305 Series Rite-Temp® Cartridges

## Adapters, Rough-in and Extension Kits

10350 Range: 3-1/2" (89 mm) -  
4-1/4" (108 mm)

## Optional Products/Accessories

K-10350 Deep rough-in kit

K-10351 Test cap for K-8300 Series valve bodies

88526 Thin Wall Trim Kit

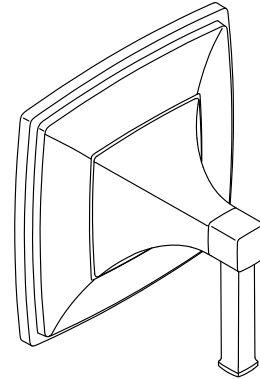

ADA

CSA B651

OBC

## Codes/Standards

ASME A112.18.1/CSA B125.1

ADA

ICC/ANSI A117.1

CSA B651





OBC

## KOHLER® Faucet Lifetime Limited Warranty

See website for detailed warranty information.

## Available Colors/Finishes

*Color tiles intended for reference only.*

Color	Code	Description
	CP	Polished Chrome
	SN	Vibrant® Polished Nickel
	BN	Vibrant® Brushed Nickel
	BL	Matte Black
	2MB	Vibrant® Brushed Moderne Brass

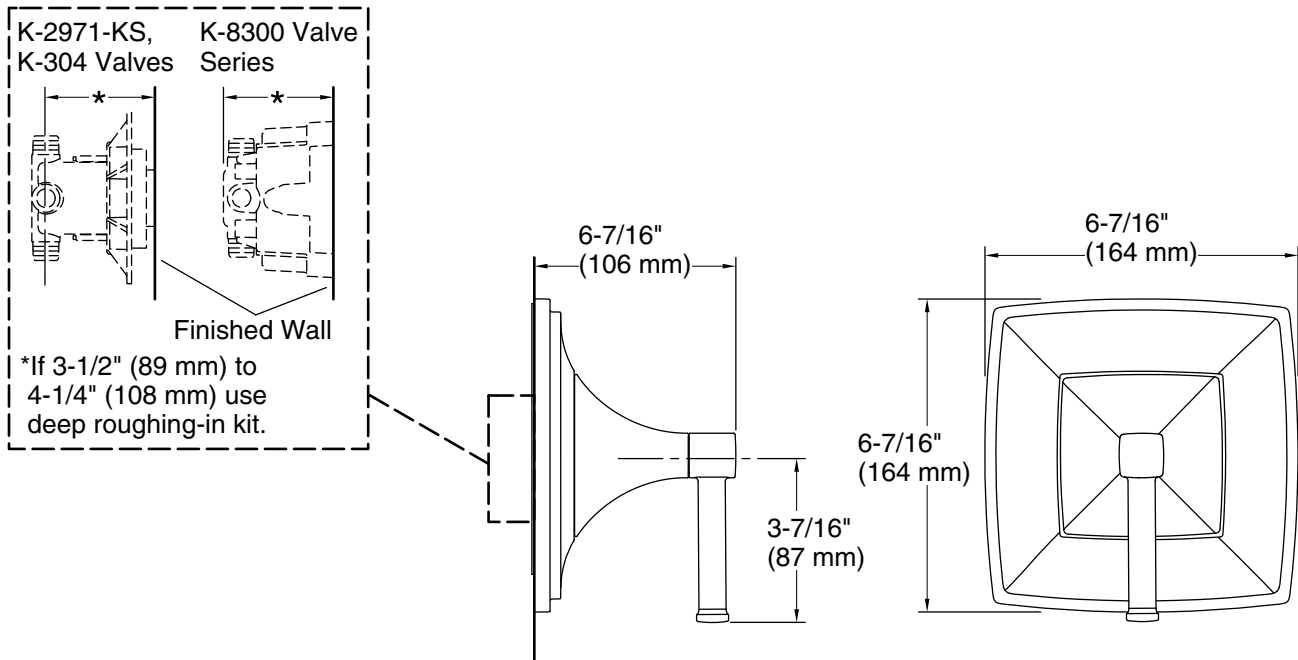

### Technical Information

All product dimensions are nominal.

### Spout:

### Notes

ADA, OBC, CSA B651 compliant when installed to the specific requirements of these regulations.