



**Underscore®**  
60" x 32" alcove bath, left drain  
**K-1957-LA**

**Features**

- Integral lumbar support
- Slotted overflow allows for deep soaking
- Integral apron creates a clean, finished look
- Integral flange helps prevent water from seeping behind wall and simplifies alcove installation
- Textured bottom surface

**Material**

- Acrylic

**Installation**

- Left drain
- Requires Clearflo slotted overflow bath drain (sold separately)
- Alcove

**Required Products/Accessories**

- K-7271 Brass Slotted Overflow Bath Drain
- K-7272 PVC Slotted Overflow Bath Drain

**Recommended Products/Accessories**

- K-23726 Drain treatment



**Codes/Standards**



- CSA B45.5/IAPMO Z124
- ASTM E162
- ASTM E662

**KOHLER® Plastic Baths and Shower Bases Lifetime Limited Warranty**

See website for detailed warranty information.

**Available Colors/Finishes**

*Color tiles intended for reference only.*

Color	Code	Description
	0	White
	96	Biscuit
	7	Black Black™

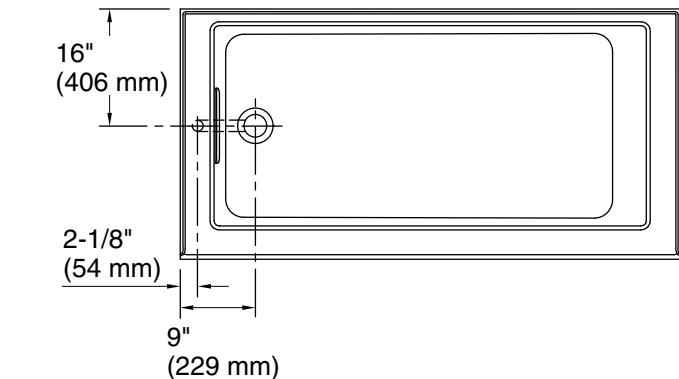

No change in measurements if connected with drain illustrated. (K-7272)

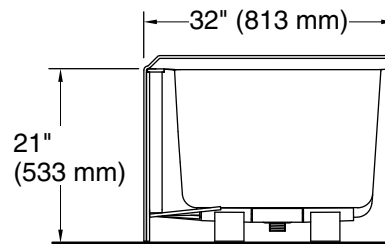
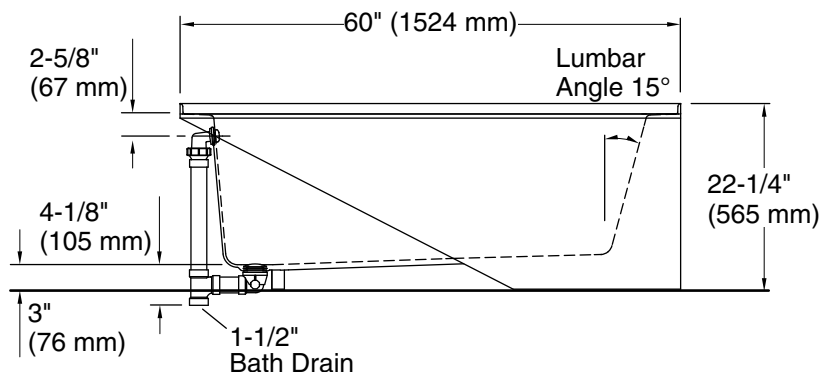
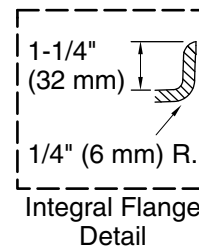

### Technical Information

All product dimensions are nominal.

Drain location:	Left
Basin area, bottom:	46-1/4" x 22" (1175 mm x 559 mm)
Basin area, top:	52" x 24" (1321 mm x 610 mm)
Weight:	105 lbs (47.6 kg)
Minimum floor load:	56 lbs/ft <sup>2</sup> (273.4 kg/m <sup>2</sup> )
Water depth:	15-1/2" (394 mm)
Water capacity:	68 gal (257.4 L)
Minimum flat for door:	2-13/16" (72 mm)

### Notes

Measure your actual product for rough-in details.

Install this product according to the installation instructions.

The hot water supply should be 70% of the capacity of the bath or greater. Installations will vary.