



Metal leg:  
Finished: Matte black powder coated



Specification:

1. Finish: See Table
2. Hardware: See Table
3. Hinge: 700.0537.25 + 600.1234.05 ( 4 pcs )
4. Slide: USE58-300-18 + USCLIP2ND-4W ( 1 set )
5. leg levelers ( 4 pcs )
6. The tolerance is +/- 1/8"

Item number	Finish	Deco Hardware	
		Item number	Qty
VN2PAS-30-BS-NT	Blue Steel	478-192MB	2
VN2PAS-30-DW-NT	Dark Walnut	478-192MBBG	2
VN2PAS-30-GR-NT	Grey	478-192MB	2
VN2PAS-30-NO-NT	Natural Oak	478-192MB	2
VN2PAS-30-WG-NT	Weathered Grey	478-192MB	2
VN2PAS-30-WH-NT	White	478-192MB	2

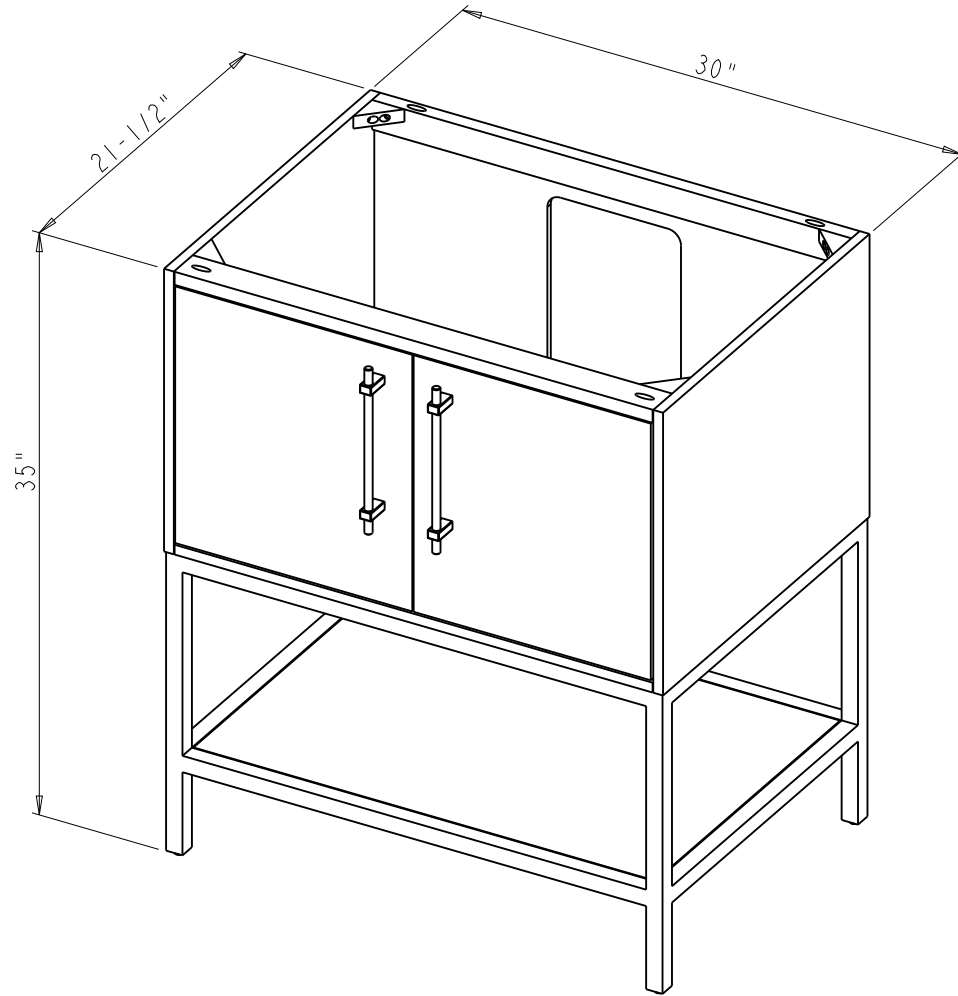
 <b>PROPRIETARY AND CONFIDENTIAL</b> THE INFORMATION CONTAINED IN THIS DRAWING IS THE SOLE PROPERTY OF HARDWARE RESOURCES INC. ANY REPRODUCTION IN PART OR AS A WHOLE WITHOUT THE WRITTEN PERMISSION OF HARDWARE RESOURCES INC. IS PROHIBITED.	ITEM:	VN2PAS-30		MATERIAL:
	FINISH:			WEIGHT:
	TOLERANCE UNLESS OTHERWISE SPECIFIED:	UNITS:	DRAWN BY:	DATE:
	X ±0.20 X.X ±0.10 X.XX ±0.05 ANGULAR: ±0.5°	SIZE:	APPROVED BY:	DATE:
DO NOT SCALE DRAWING	SHEET:	RELEASE LEVEL:	REVISION:	PROJECTION  9 Hugo.cai Dec-15-22



 <b>PROPRIETARY AND CONFIDENTIAL</b> THE INFORMATION CONTAINED IN THIS DRAWING IS THE SOLE PROPERTY OF HARDWARE RESOURCES INC. ANY REPRODUCTION IN PART OR AS A WHOLE WITHOUT THE WRITTEN PERMISSION OF HARDWARE RESOURCES INC. IS PROHIBITED.	ITEM#: VN2PAS-30	MATERIAL:
	FINISH:	WEIGHT: 9
	PROJECTION 	
	TOLERANCE UNLESS OTHERWISE SPECIFIED: X ±0.20 X.X ±0.10 X.XX ±0.05 ANGULAR: ±0.5° DO NOT SCALE DRAWING	UNITS:
	DATE: Dec-15-22	
	APPROVED BY:	DATE:
	RELEASE LEVEL:	REVISION:

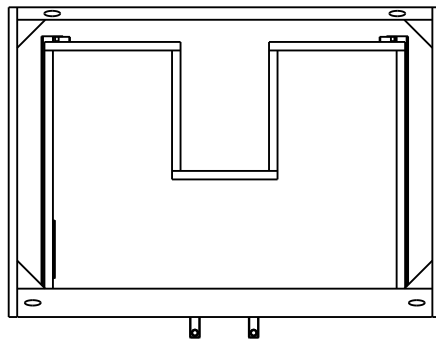
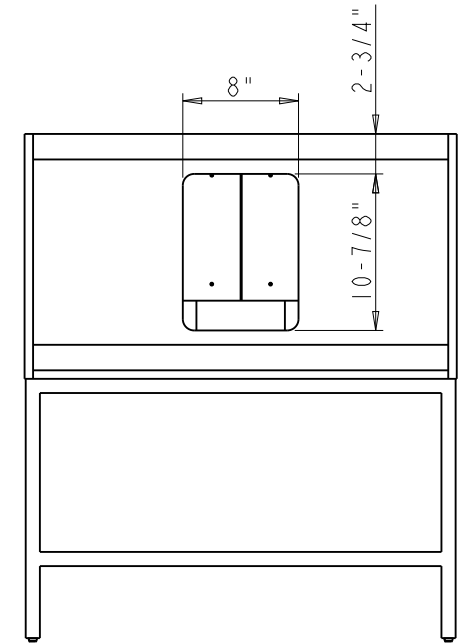
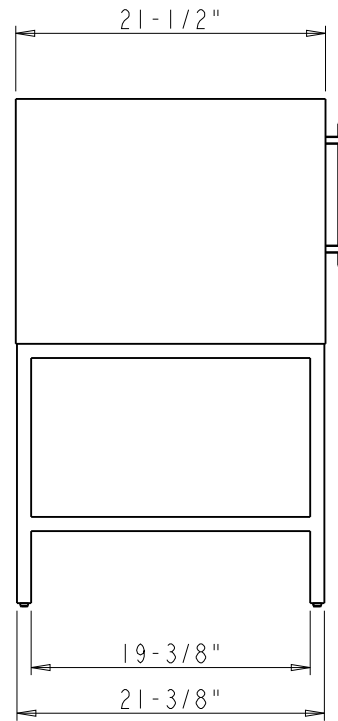
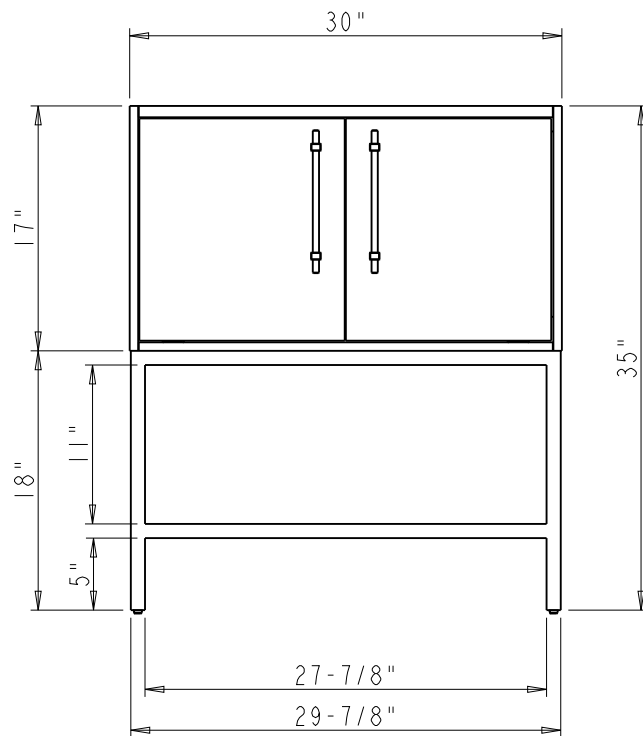

	ITEM#: VN2PAS-30		MATERIAL:	
	FINISH:		WEIGHT:	
<b>PROPRIETARY AND CONFIDENTIAL</b> THE INFORMATION CONTAINED IN THIS DRAWING IS THE SOLE PROPERTY OF HARDWARE RESOURCES INC. ANY REPRODUCTION IN PART OR AS A WHOLE WITHOUT THE WRITTEN PERMISSION OF HARDWARE RESOURCES INC. IS PROHIBITED.	UNITS:		DRAWN BY: <i>Hugo.cai</i>	
	TOLERANCE UNLESS OTHERWISE SPECIFIED: X ±0.20 X.X ±0.10 X.XX ±0.05 ANGULAR: ±0.5°		DATE: Dec-15-22	
	DO NOT SCALE DRAWING		APPROVED BY:	
			DATE:	
	SHEET:		RELEASE LEVEL:	
			REVISION:	