

Lightology

lightology.com
866-954-4489
05-20-26

Project: _____

Company: _____

Location: _____ Fixture Type: _____

SPEC #: **WAC1314029**

Approved On: _____ Approved By: _____

Double Entendre Pendant By WAC Lighting



Description

The Double Entendre Pendant features an open, airy design composed of overlapping rectangles in contrasting finishes. The frames are lined with LED strips to provide warm, diffused downlight. Dimmable with ELV (100-10%) or TRIAC (100-5%) dimmers.

Specifications

COLOR	N/A
BODY FINISH	Black / Aged Brass
WATTAGE	66W
DIMMER	Low Voltage Electronic
DIMENSIONS	42"L x 8.63"W x 0.62"H
INTEGRATED LED MODULE	2 x LED/33W/120-277V LED

Technical Information

LAMP LIFE	50000 hours
COLOR RENDERING	90 CRI
LAMP COLOR	3000K
LUMENS/WATT	31.12
LUMINOUS FLUX	1027 lumens



Shown in black / aged brass

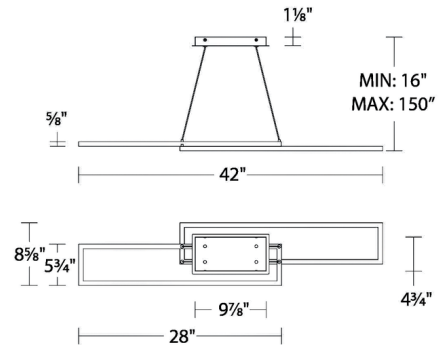

CLICK TO VIEW PRODUCT

Notes: