

Features

- Left-hand trip lever
- For use with K-11452 and K-11453 Kelston Comfort Height® two-piece toilets
- Coordinates with other products in the Kelston collection

Material

- Solid-brass construction for durability and reliability
- KOHLER finishes resist corrosion and tarnishing

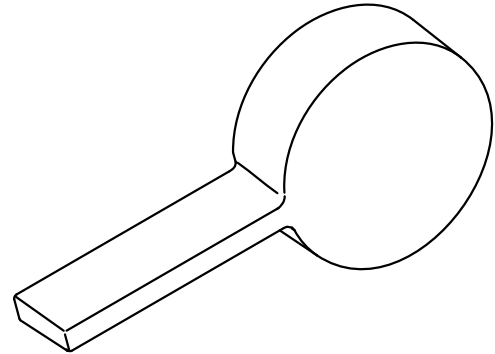

ADA **CSA B651** **OBC**

Codes/Standards

ASME A112.18.1/CSA B125.1

ADA

ICC/ANSI A117.1

CSA B651









OBC

KOHLER® One-Year Limited Warranty

See website for detailed warranty information.

Available Colors/Finishes

Color tiles intended for reference only.

Color	Code	Description
	SN	Vibrant® Polished Nickel
	AF	Vibrant® French Gold
	BN	Vibrant® Brushed Nickel
	BV	Vibrant® Brushed Bronze
	BL	Matte Black
	2MB	Vibrant® Brushed Moderne Brass
	BGP	Vibrant Brushed Graphite
	TT	Vibrant Titanium
	DR	Deep Bronze

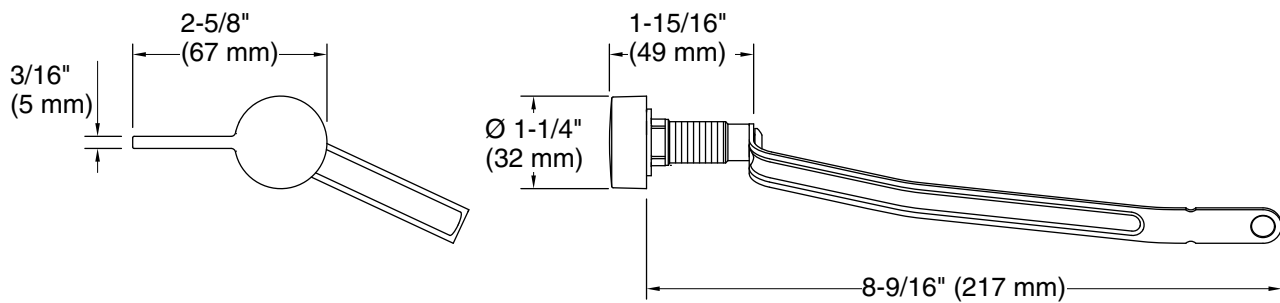

Technical Information

All product dimensions are nominal.

Material: Brass

Notes

ADA, OBC, CSA B651 compliant when installed to the specific requirements of these regulations.