

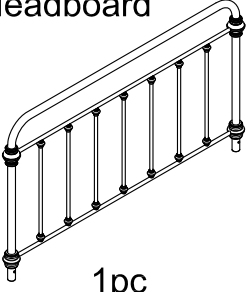

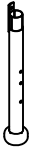



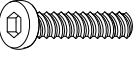

ASSEMBLY INSTRUCTION

E411BQ-HB 7 SPINDLES METAL QUEEN HEADBOARD

A Headboard  1pc	B Extension leg  2pcs	C Adjustable plate  2pcs	D Bolt 1/4",57mm  4pcs
E Bolt 1/4",22MM  6pcs	F Flat washer ø16mm  14pcs	G Plastic Washer ø25mm  8pcs	H Nut 1/4"  8pcs
I Allen wrench 4X4MM  1pc	J Wrench 11.3MM  1pc		

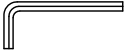

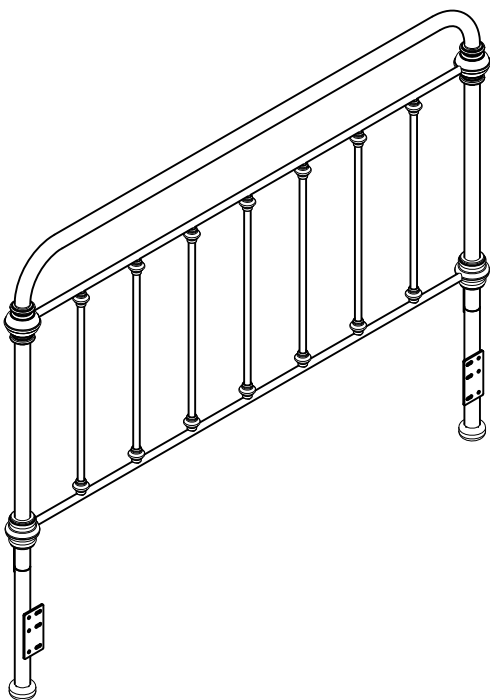
This page lists all the contents included in the box. Please take the time to identify the hardware as well as the individual components to this product. As you unpack and prepare for assembly, place the contents on a carpeted or padded area to protect them from damage.

1

Assemble the headboard (A) to the extension leg (B).

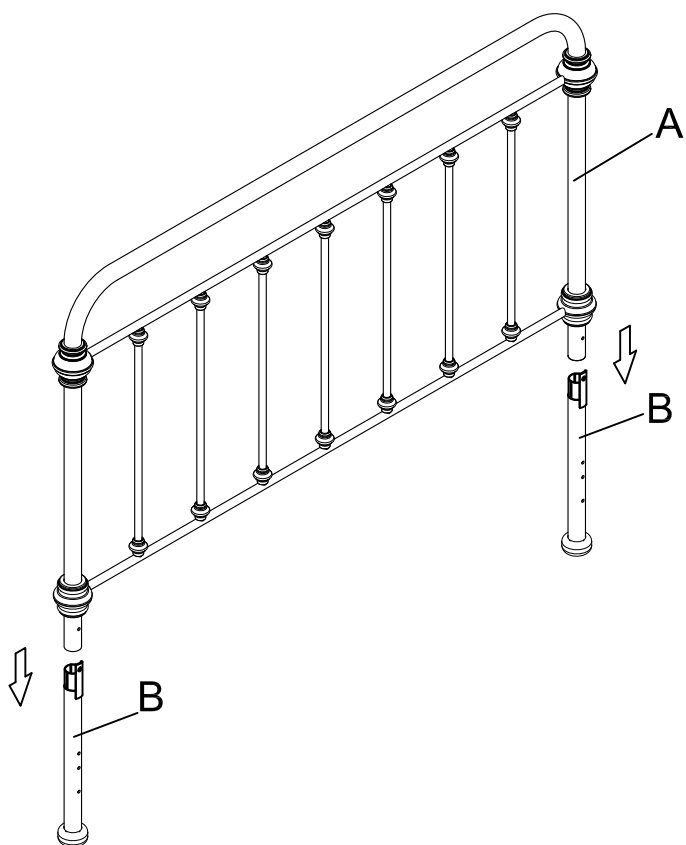
**2**

Assemble the extension leg (B) to the headboard (A) with 2pcs bolts (E) and flat washers (F), then tighten with allen wrench (I).

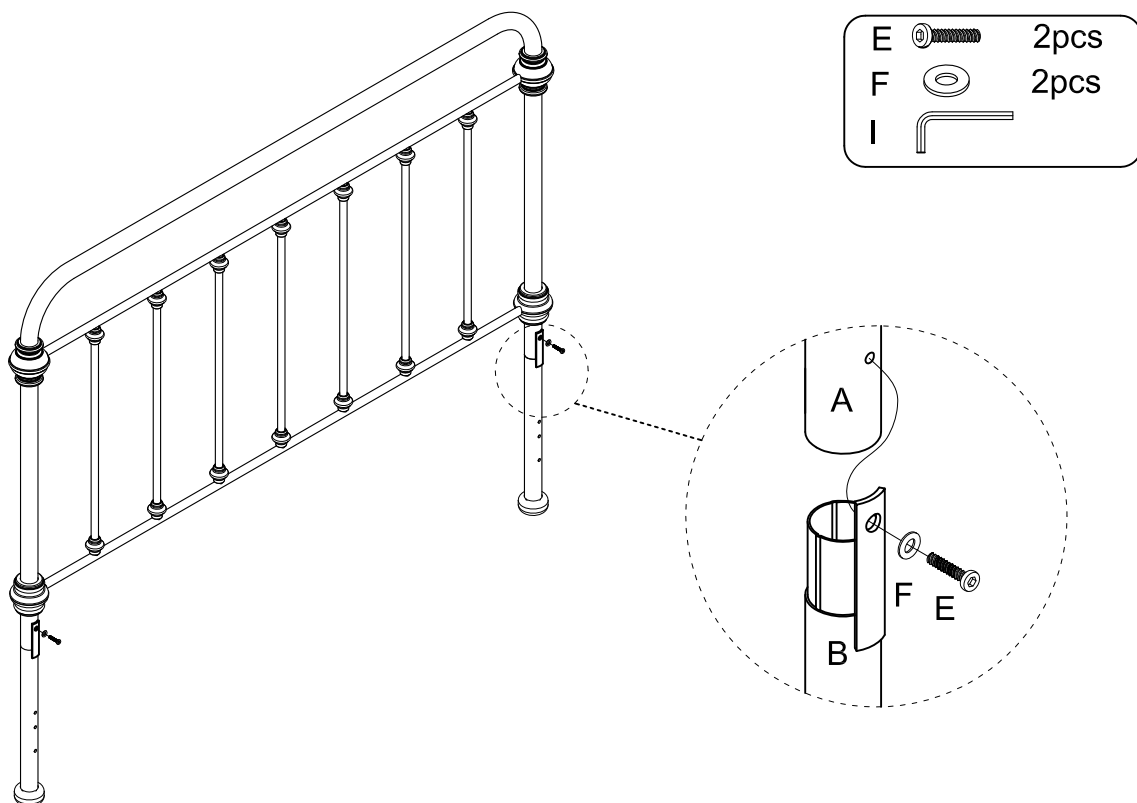

3 Assemble the adjustable plate (C) to the extension leg (B) with 4pcs bolts (D), 4pcs flat washers (F), 4pcs plastic washer (G) and 4pcs nuts (H), then tighten with allen wrench (I) and wrench (J).

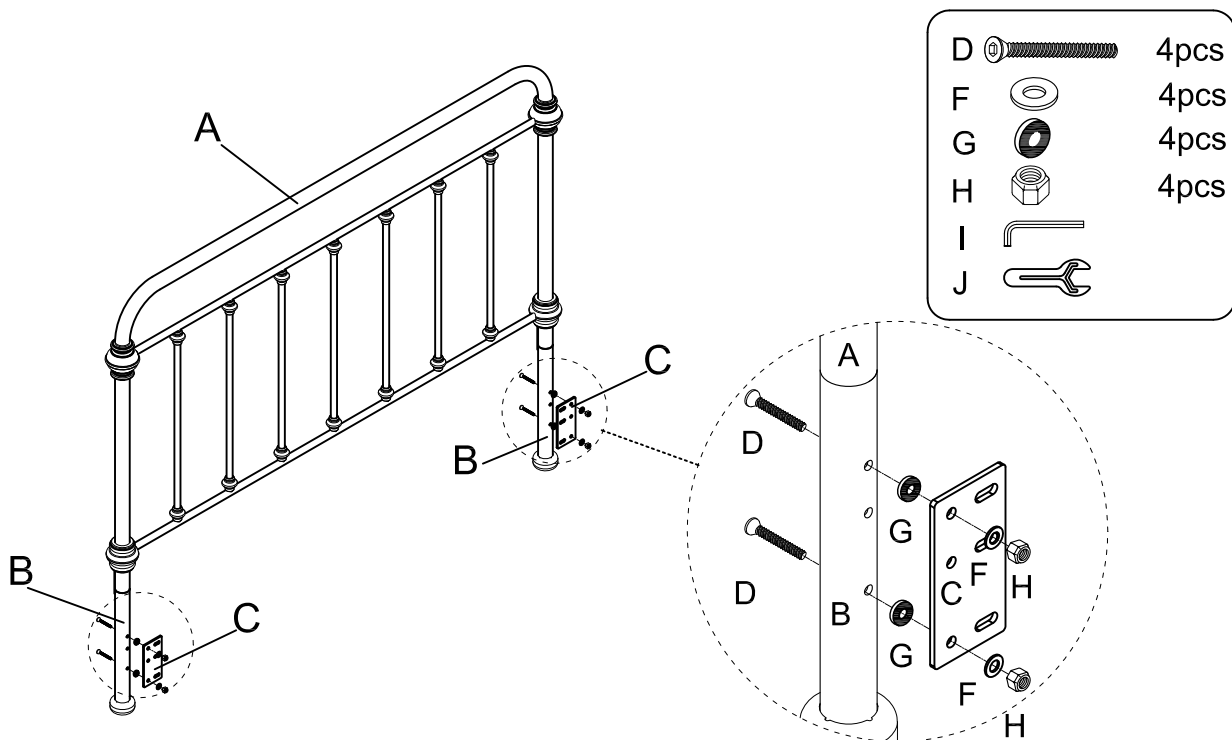

4 Assemble rails (belongs to customer) to the adjustable plate (C) with 4 pcs bolts (E), 8pcs flat washers (F), 4pcs plastic washer (G) and 4pcs nuts (H), then tighten with allen wrench (I) and wrench (J).

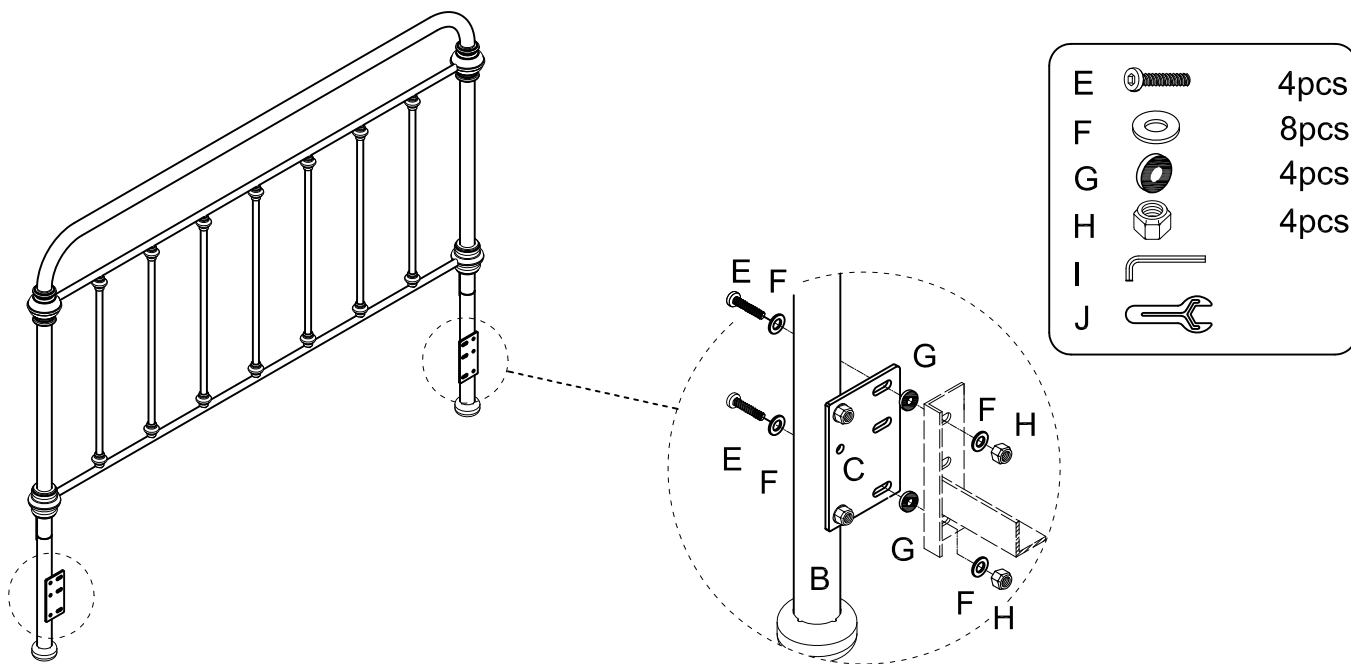

Cleaning & Care

Treat surface with care. Surface is resistant to scratches but is not scratch resistant. Clean surfaces with a dry or damp soft cloth. Do not use abrasive cleaners. Hardware may loosen over time. Periodically check that all connections are tight.