

# CAPSULE

## Angle Arm Sofa

#1041

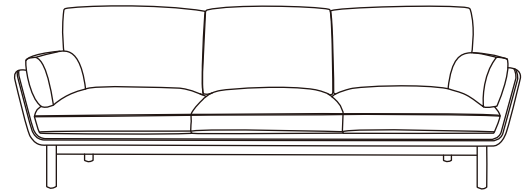

- ASSEMBLE FURNITURE ON A SOFT SURFACE (LIKE A CARPET OR BLANKET).
- BE CAREFUL NOT TO OVER-TIGHTEN SCREWS.
- QUESTIONS? FIND US AT [CONTACT@CAPSULEHOME.COM](mailto:CONTACT@CAPSULEHOME.COM)

### HARDWARE (ACTUAL SIZE) AND TOOLS

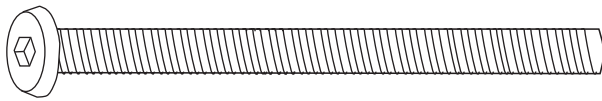

H1 x 4  
BOLT

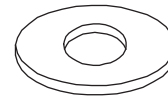

H2 x 7  
WASHER



H3 x 7  
LOCK  
WASHER

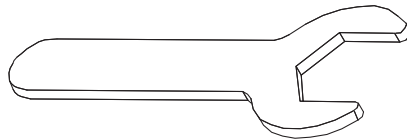

FLAT WRENCH

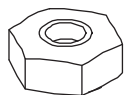

H4 x 3  
NUT



ALLEN WRENCH

### ASSEMBLY INSTRUCTIONS

#### STEP 1

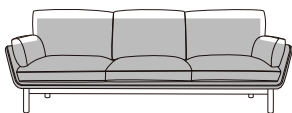

\*INSERT THE BACK PANEL AND THEN FLIP THE FRAME 90 DEGREES FOR EASY ASSEMBLY.

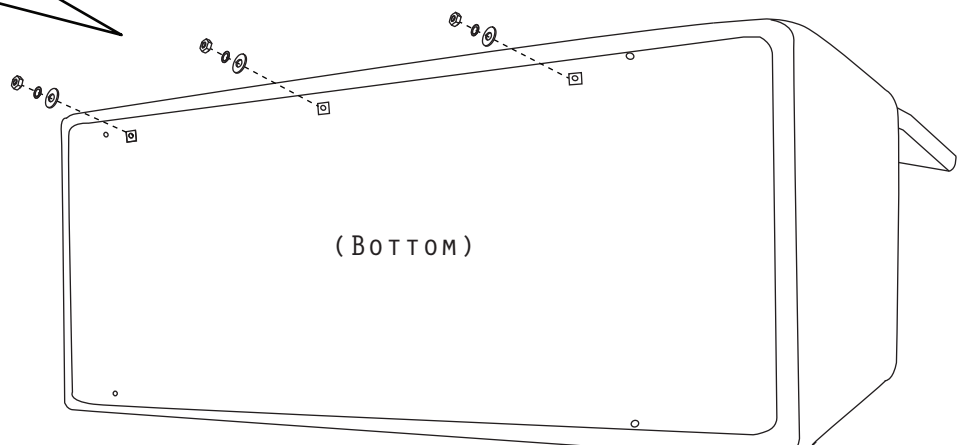
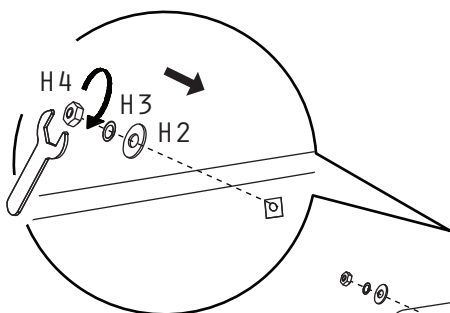

STEP 2

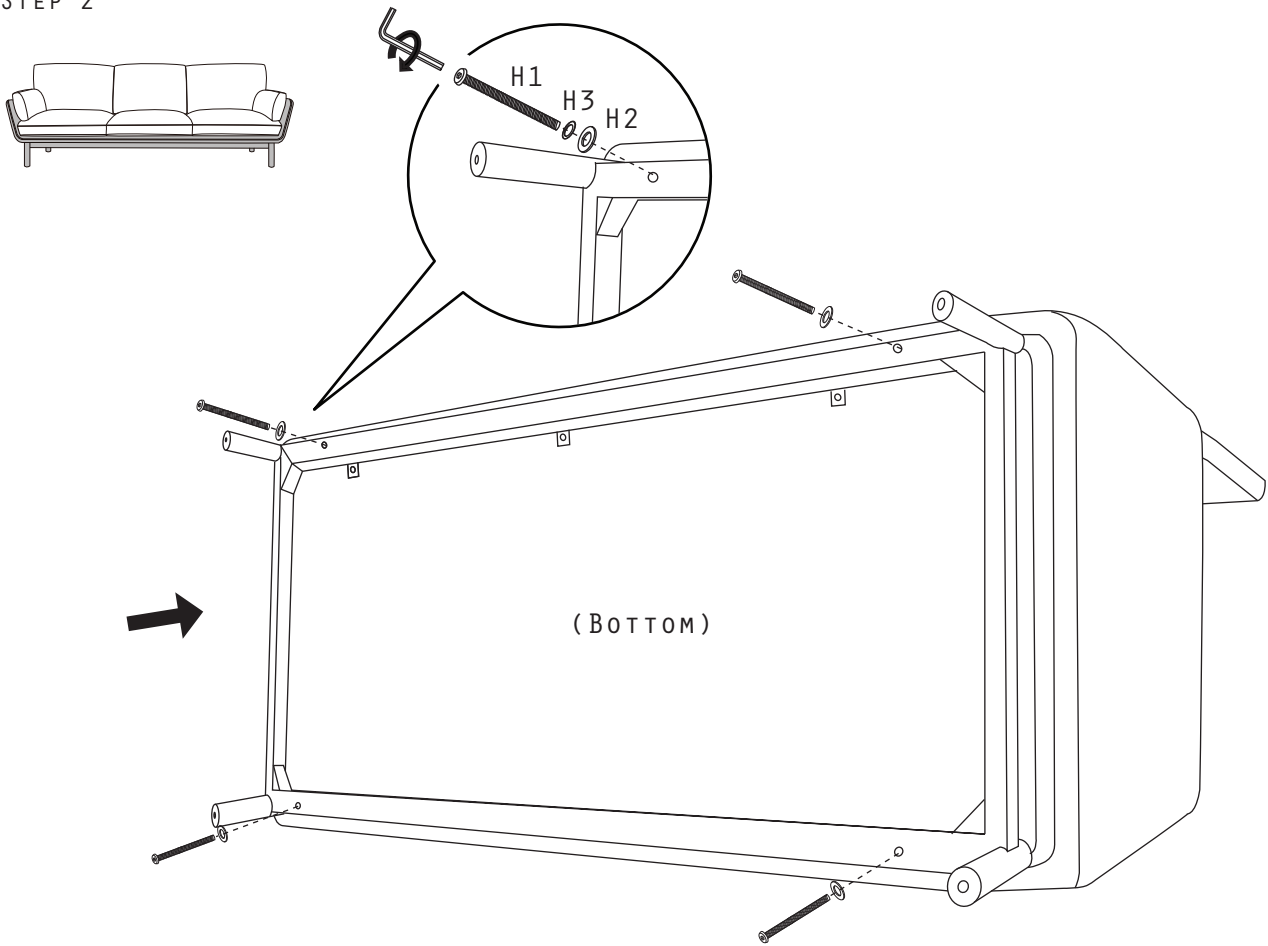

STEP 3

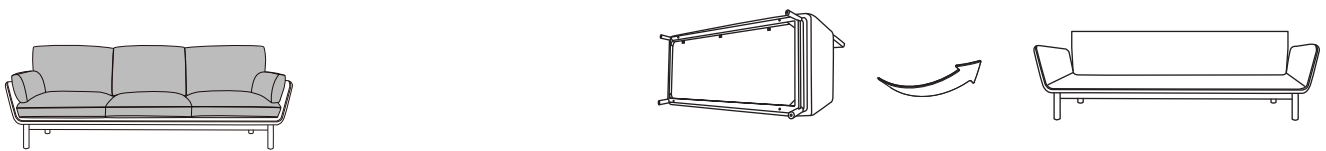

*Place the cushions in and take a seat!*

