







HEKMAN®

X A HOWARD MILLER COMPANY

79411 & 79431 WRITING DESK

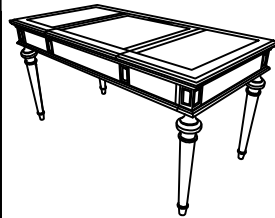
HARDWARE LIST			
A	B	C	D
ALLEN BOLT $\frac{5}{16}$ " x 2" (10 PCS.)	FLAT W. M8 (10 PCS.)	SPRING W. M8 (10 PCS.)	ALLEN KEY L5 (FOR BOLT $\frac{5}{16}$ " 1 PC.
			

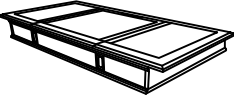

PART INSIDE	
1	2
TOP ASSEMBLY (1 Pc)	LEGS (2 Pcs)
	

Assembly Instruction

STEP 1.

LAY THE TOP ASSEMBLY UPSIDE DOWN ON A SOFT, CLEAN AND FLAT SURFACE, AND REMOVE END DRAWER.

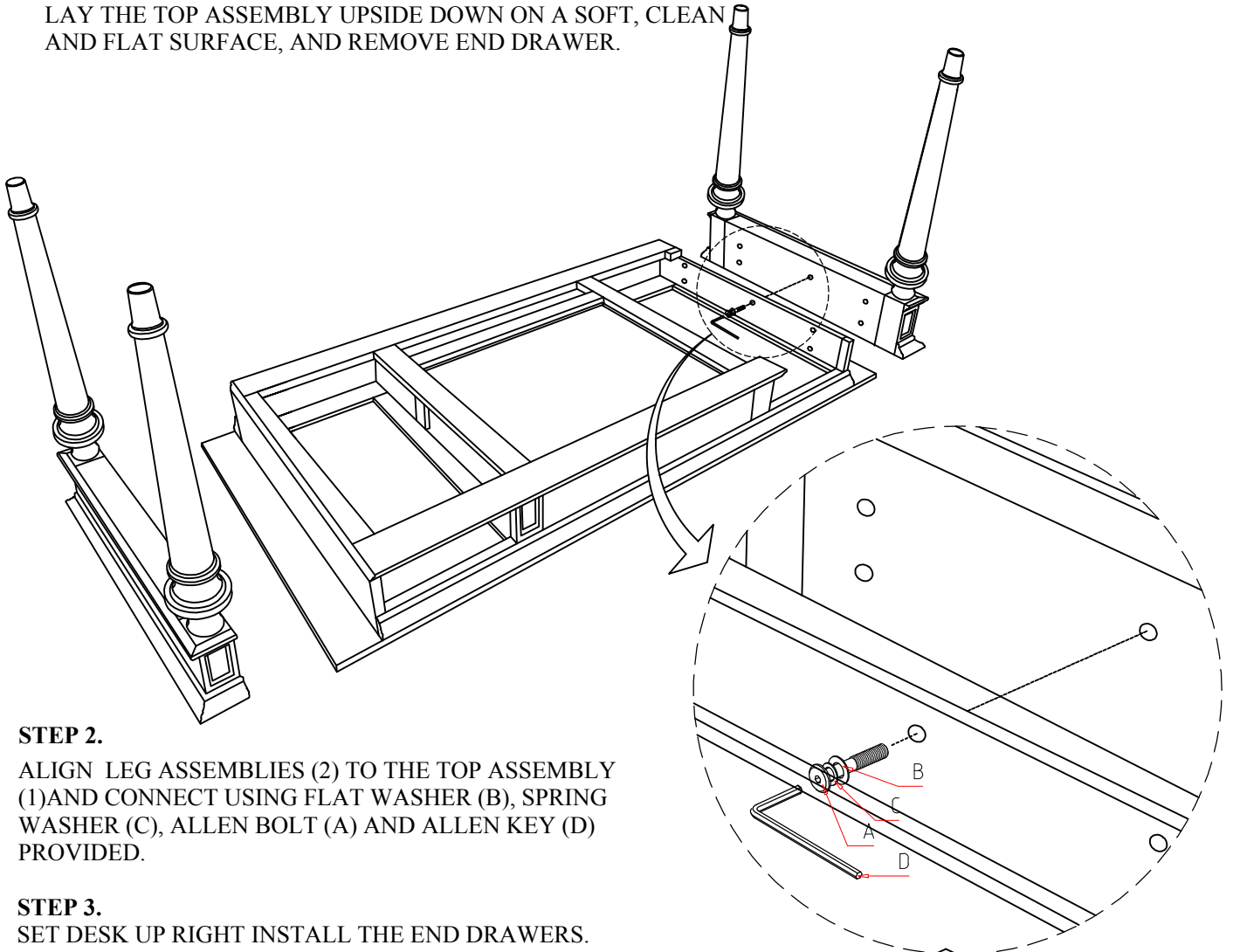

STEP 2.

ALIGN LEG ASSEMBLIES (2) TO THE TOP ASSEMBLY (1) AND CONNECT USING FLAT WASHER (B), SPRING WASHER (C), ALLEN BOLT (A) AND ALLEN KEY (D) PROVIDED.

STEP 3.

SET DESK UP RIGHT INSTALL THE END DRAWERS.