

SAFETY INFORMATION

Please read and understand this entire manual before attempting to assemble, install or operate the product.

WARNING

- RISK OF ELECTRIC SHOCK - Before beginning installation, turn off electricity at the circuit breaker box or the main fuse box.

CAUTION

- For your safety, read instructions completely before beginning installation.
- If in doubt about electrical installation, consult a licensed electrician.

TOOLS REQUIRED

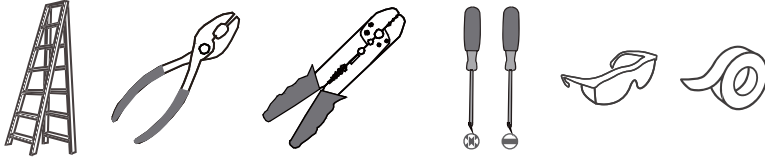

Ratings	120~277Vac, 50~60Hz	
	Model No.	Wattage
	BY5026MBK	56W

CARE AND MAINTENANCE

- Wipe clean using soft, dry cloth or static duster. Always avoid using harsh chemicals and abrasives to clean fixture as they may damage the finish.

If you need further assistance call Quozel Customer Care at 1-800-645-3184 (9:00am - 5:00pm EST), or visit us on-line at www.quezel.com.

PACKAGE CONTENTS

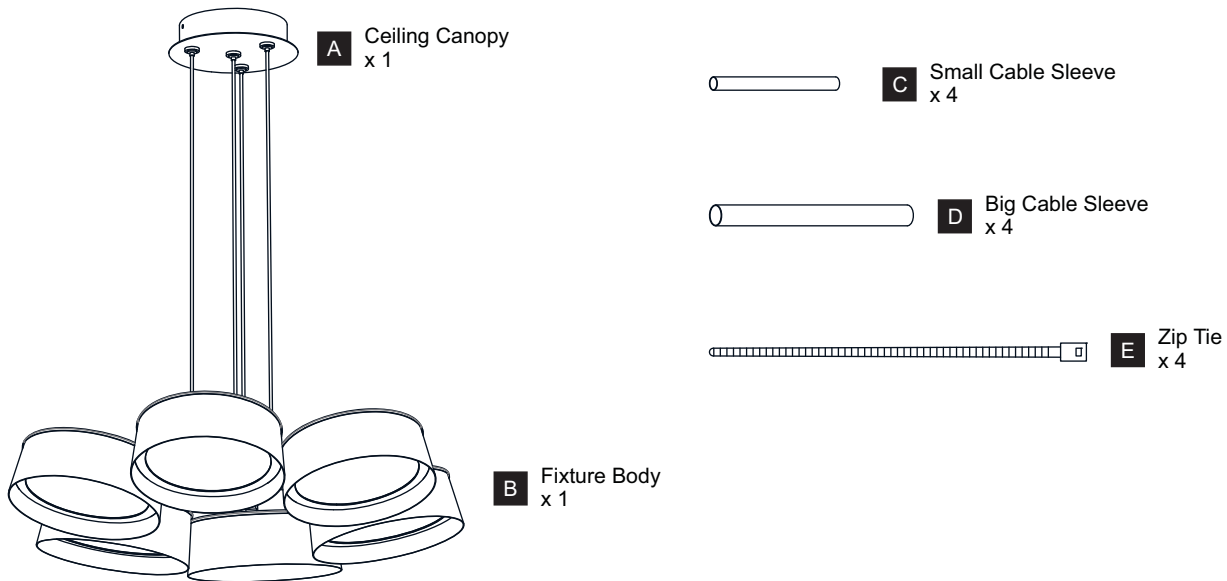

MOUNTING HARDWARE



IMPORTANT: PLEASE READ CAREFULLY BEFORE INSTALLATION!

- This fixture uses steel cables that are current carrying wires. The cables are safe to touch when only touching one cable. Do **NOT** allow the cables to touch each other and do not touch two cables at the same time, after power has been connected. The current carrying wires uses low voltage which is safe if touched accidentally.
- The fixture has a short circuit protection. If any of the following situations occurs unexpectedly, the fixture will power off.
 1. Steel cables are touched by another steel cable unexpectedly
 2. Steel cables are twisted around another.If any of the above occurs, it may cause a spark where the cables touch which will cause the fixture to power off. If this occurs, turn the wall switch off and confirm that the steel cables are not touching another cable. This includes inside the canopy and the visible cables outside the canopy. Then turn the wall switch back on.
- To prevent potential risks, please make sure that the fixture body is level after adjustment.
- The fixture hanging height cannot be adjusted after installation. Before power on the fixture the first time, please make sure that you have achieved the desired hanging height. For safety purpose, the extra steel cables inside of the ceiling canopy will be cut off and insulated by using plastic tubes. Please refer to the relative steps of insulating steel cables as below.

INSTALLATION

1 Adjust Cord Length: Fixture Height Adjustable 10" to 100"

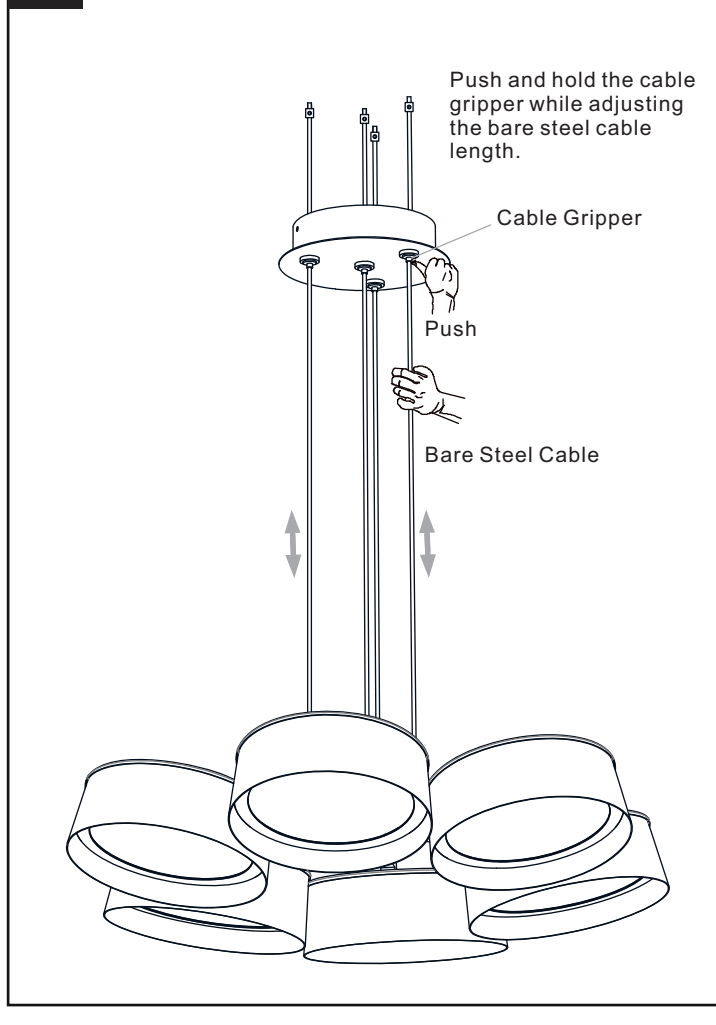

2 Cut Each Steel Cable and Install Cable Sleeves

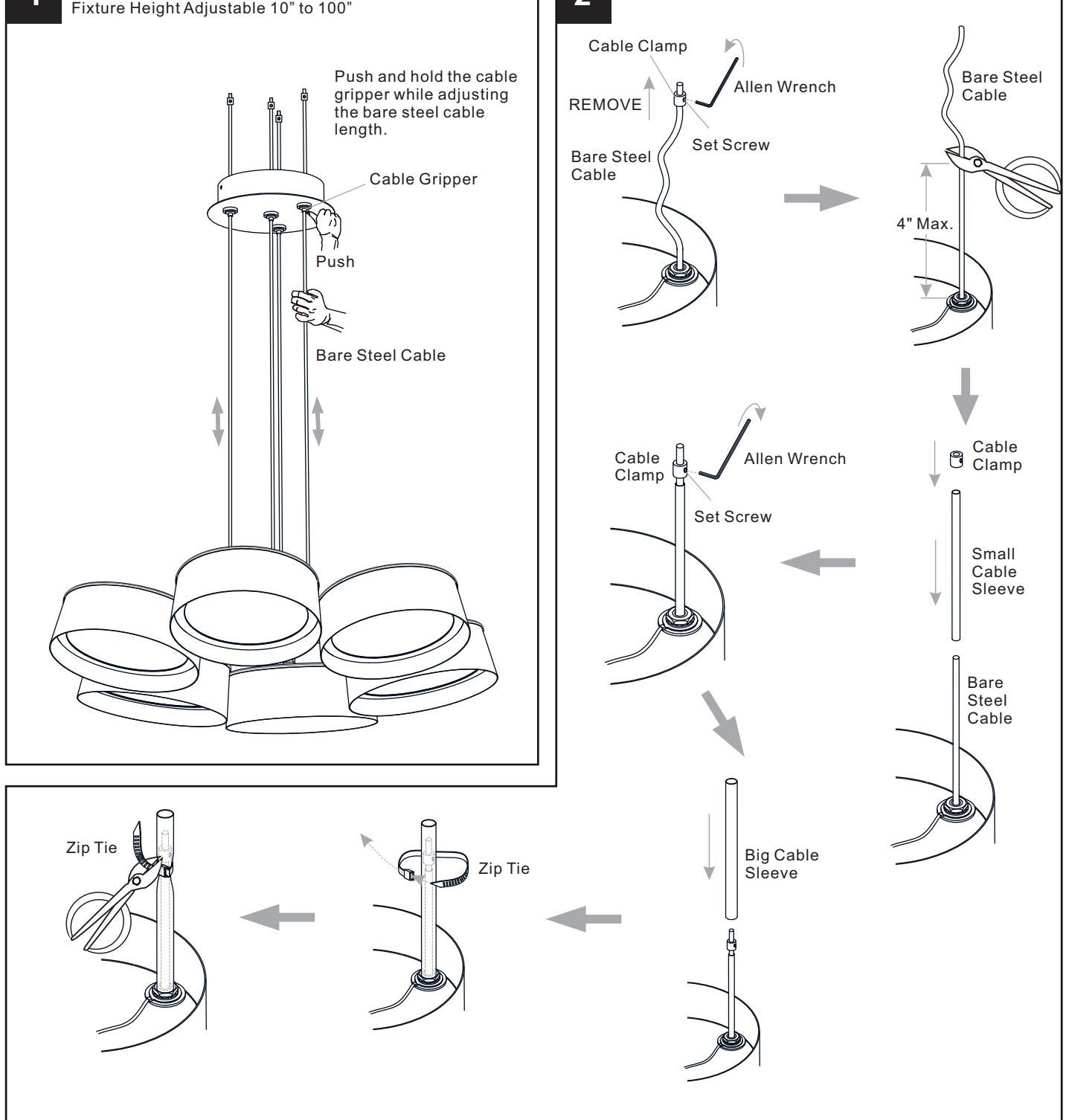

INSTALLATION

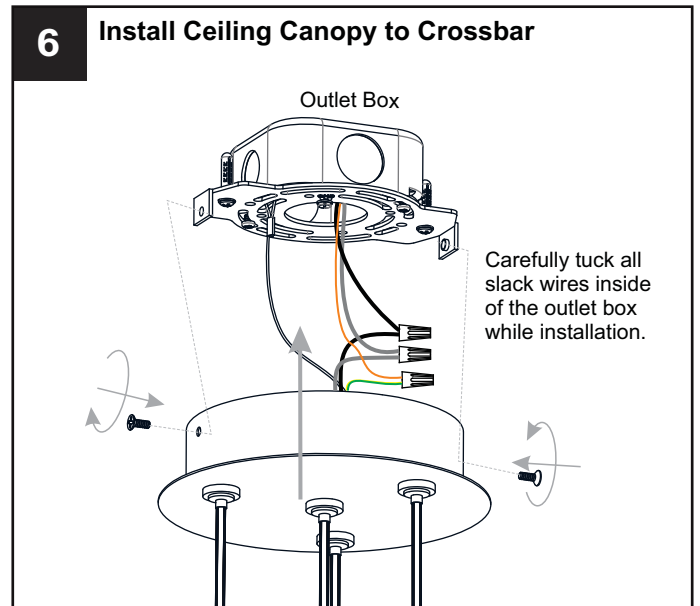
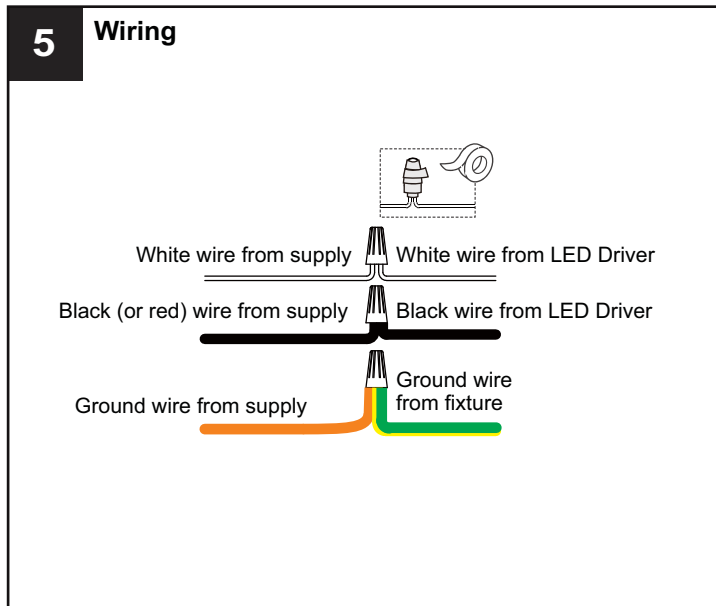
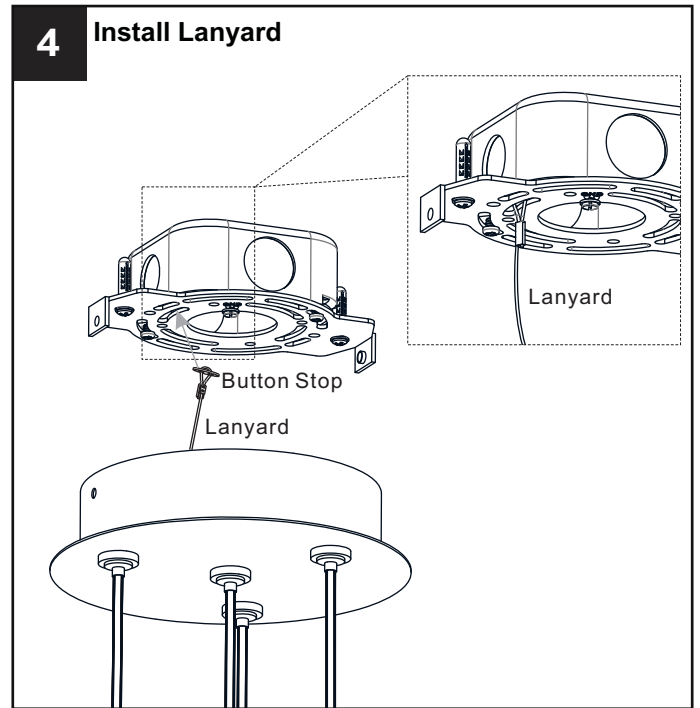
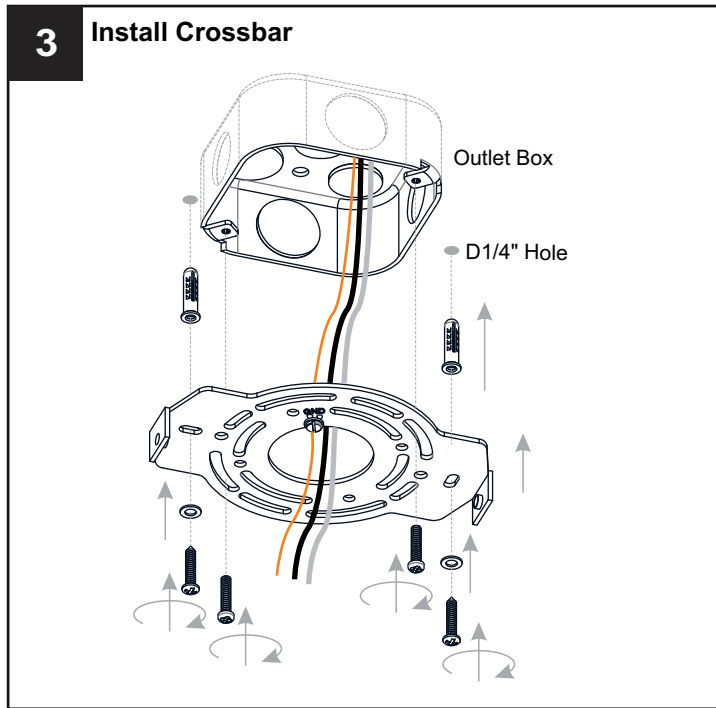

Your installation is now complete! Restore electricity and save this sheet for future reference.