

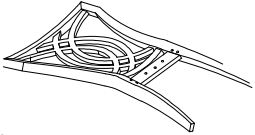









ASSEMBLY INSTRUCTION

SIDE CHAIR

A Chair Back 	B Seat 	C Front Leg 	D Bolt 1/4"×1-1/2" 
1 pc E Lock Washer 1/4" 	1 pc F Flat Washer 1/4" 	2 pcs G Bolt 5/16"×2" 	1 pc H Bolt 5/16"×3" 
1 pc I Lock Washer 5/16" 	1 pc J Flat Washer 5/16" 	4 pcs K Allen Wrench 1/6" 	4 pcs
8 pcs	8 pcs	1 pc	

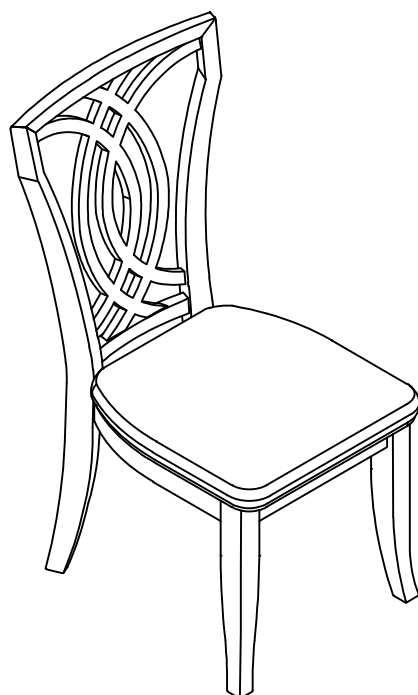

This page lists all the contents included in the box. Please take the time to identify the hardware as well as the individual components to this product. As you unpack and prepare for assembly, place the contents on a carpeted or padded area to protect them from damage.

1

Place the Seat (B) upside down on the smooth carpet surface. Attach the Front Leg (C) to Seat (B) by Bolt (G), Lock Washer (I) and Flat Washer (J) with Allen Wrench (K).

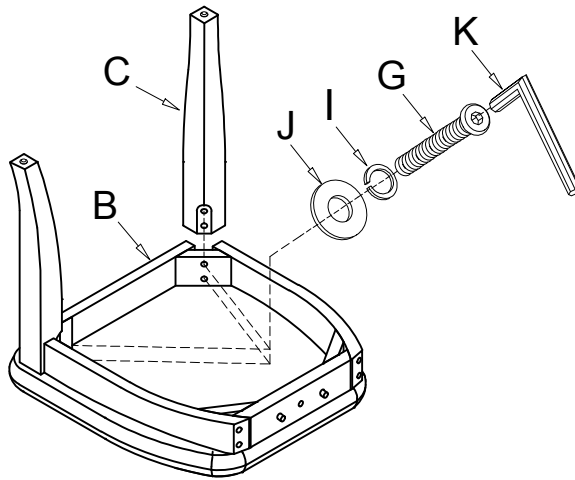

Take the Allen Wrench, and turn the bolts until the legs are secured. **DO NOT TIGHTEN COMPLETELY.** Stop when you feel you are adding force to tighten the bolt.

2

Place the Chair Back (A) with Seat (B) on smooth carpet surface. Attach the Chair Back (A) with Seat (B) by Bolt (H), Lock Washer (I) and Flat Washer (J) with Allen Wrench (K). Then tighten Chair Back (A) and Seat (B) by Bolt (D), Lock Washer (E) and Flat Washer (F) with Allen Wrench (K).

Stand chair up on an even surface and check that it is balanced. If there is a slight wobble, apply downward pressure in the corner where a leg is uneven. Keeping pressure in that corner, tighten all bolts. If balanced, apply downward pressure evenly in the center and tighten all bolts. Do not over-tighten beyond hole depth.

Helpful Tip:

-Instead of applying downward pressure while reaching under to tighten bolts, have someone sit in the chair while you tighten the bolt.

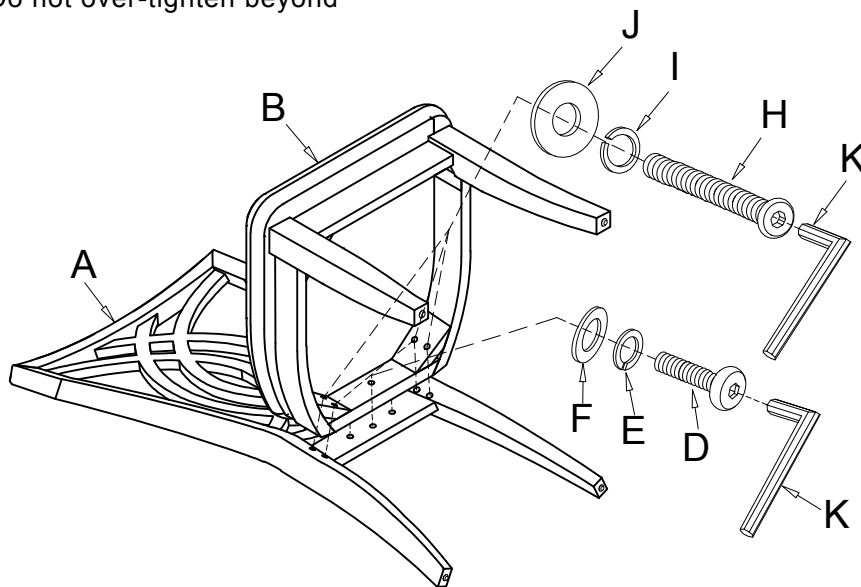

Cleaning & Care

Treat surface with care. Surface is resistant to scratches but is not scratch resistant. Clean surfaces with a dry or damp soft cloth. Do not use abrasive cleaners. Hardware may loosen over time. Periodically check that all connections are tight.