

Straight Blade Devices
 20A, 125V, 2 Pole, 3 Wire Grounding
 Commercial Specification Grade Duplex
 Receptacles

HUBBELL

Features

- Tamper-resistant shutter complies with national electrical code requirements
- Smooth face
- Triple wipe contacts

Ordering Information

Description	Device Color	UPC	Catalog Number
Tamper-Resistant, smooth face, side wired only	White	783585144306	CR20WHITR

Listings

UL Listed to UL498 File No. E2186
 Certified to CSA, C22.2, No. 42
 NEMA® WD-6 Compliant

Specifications

Face	Nylon
Base	Nylon
Power Contacts	.030 in. (.8) Brass
Mounting Strap	.040 in. (1) Galvanized steel
Terminal Screws	Plated steel
Automatic Self-grounding Staple	Stainless steel
Mounting Screws	Galvanized steel

Performance

Electrical	
Current Interrupting	Certified for current interrupting at full rated current
Dielectric Voltage	Withstands 2,000V minimum
Mechanical	
Product Identification	Ratings are a permanent part of the device
Terminal Accommodation	#12-#10 AWG copper stranded or solid conductor only
Terminal Identification	Terminals identified in accordance with UL 498 and CSA
Environmental	
Flammability	UL 94 V-2
Operating Temperatures	Maximum continuous 75°C; minimum -40°C (w/o impact)

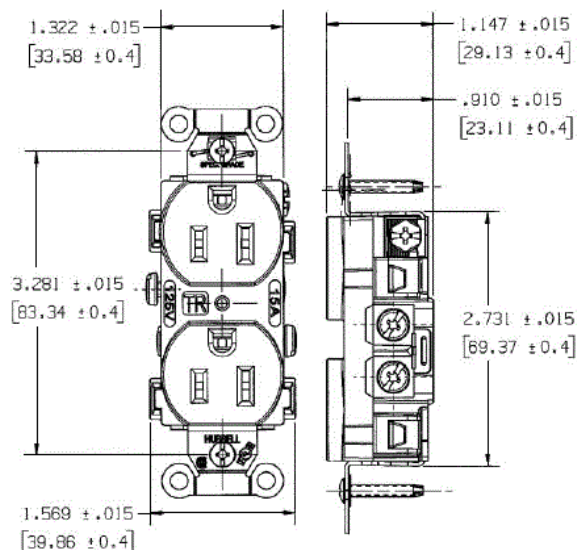

Accessories

Wallplate or Weatherproof Cover Duplex Opening

Resources

Customer Use Drawing
 eCatalog

Dimensions in Inches (mm)

Hubbell Wiring Device-Kellems • Hubbell Incorporated (Delaware) • 40 Waterview Drive • Shelton, CT 06484

Phone (800) 288-6000 • Fax (800) 255-1031 • Specifications subject to change without notice.

